

# KENWOOD

GPS NAVIGATION SYSTEM

## DNX520VBT

---

## INSTRUCTION MANUAL

Kenwood Corporation



# Contents

<b>Before Use</b>	<b>4</b>
<b>Notes</b>	<b>5</b>
<b>How to read this manual</b>	<b>8</b>

<b>Functions of the buttons on the front panel</b>	<b>10</b>
<b>Getting Started</b>	<b>12</b>
How to Display the Navigation Screen	12
How to Select the Source	12
How to Set a Medium / a Device	13
<b>Basic Operation</b>	<b>14</b>
How to Display the Source Control Screen	14
How to Display Top Menu Screen	15
Operation on the Playback Screen of Visual Sources	16
How to Display the Easy Control Screen	17

<b>Initial Setup</b>	<b>77</b>
----------------------	-----------

<b>Watching DVD/Video CD</b>	<b>18</b>
Playback Screen	18
Easy Control Screen	18
Source Control Screen	19
DVD-VIDEO Disc Menu	20
DVD-VR Menu Control	21
Video CD Zoom Control	22
<b>Music Disc/ Audio File Listening &amp; Video File/ Picture File Watching</b>	<b>23</b>
Source Control Screen	23
List Select	24
USB device select	25
Link search (Audio file in USB)	26
Playback Screen (Video file, Picture file)	26
Easy Control Screen (Video file, Picture file)	27
Picture Control	27
Movie Menu Control	28
<b>iPod Control</b>	<b>29</b>
Playback Screen	29
Easy Control Screen	29
Source Control Screen	30
iPod List	31
Link Search (Music file)	31

<b>Radio Listening</b>	<b>32</b>
Source Control Screen	32
Preset Select	33
Auto Memory	33
Manual Memory	34
Radio Text	34
Traffic Information	35
Search by Program Type	35
<b>TV Watching</b>	<b>36</b>
Function During TV Screen	36
Easy Control Screen	36
Source Control Screen	37
TV Menu (only with KTC-D500E optional accessory) connected)	37
Preset Select	39
Set Station Name	39
<b>Other Functions</b>	<b>40</b>
Character Entry	40
Muting Audio Volume upon Reception of Phone Call	40
<b>Screen Control</b>	<b>41</b>
Screen Control	41

**Hands-Free Phoning 42**

Before Use	42
Downloading the Phonebook	42
Receiving a Call	43
During a Call	43
Call Waiting	43
Making a Call	44
Calling by Phonebook	45
Calling by Entering a Phone Number	45
Making a Call Using Call Records	46
Calling by Voice Recognition	46
Controlling Tone-based Services	47
Setting Up the Hands-Free Phone	48
Voice Registration	49
Key Word Voice Registration	50
Phone Number Preset	51
SMS (Short Message Service)	52

**Audio Control 54**

Audio Control Menu	54
Audio Control	54
Equalizer Control	55
Tone Setup	55
Zone Control	56

**Setup Menu 57**

How to Display SETUP Menu Screen	57
DivX Setup	58
Software Information	58
User Interface	59
Language Setting	60
Touch Panel Adjustment	61
Clock Setup	61
Security Setup	62
Setup Memory	63
Entering Background	64
Panel Color Coordinate	65
Screen Adjustment	66
Registering Bluetooth Unit	66
Registering Bluetooth Unit PIN Code	68
Bluetooth Unit Connection	68
Bluetooth Hands-Free/Audio Output Setup	69
AV Input Setup	69
AV Interface Setup	70
Navigation Setup	70
Speaker Setup	71
DVD Setup	72
DVD Language Setup	73
DVD Parental Level Setup	73
Disc Setup	74
USB Setup	75
iPod Setup	75
Tuner Setup	76
TV Setup	76

**Initial Setup 77****Status bar Indicator items 78****DVD Language Codes 79****Help? Troubleshooting 80****Help? Error 81****Specifications 82**

# Before Use

## ▲WARNING

### To prevent injury or fire, take the following precautions:

- To prevent a short circuit, never put or leave any metallic objects (such as coins or metal tools) inside the unit.
- Do not watch or fix your eyes on the unit's display when you are driving for any extended period.

### How to reset your unit

- If the unit or the connected unit fails to operate properly, press the Reset button. The unit returns to factory settings when the Reset button is pressed.
- Remove the USB device before pressing the Reset button. Pressing the Reset button with the USB device installed can damage the data contained in the USB device. For how to remove the USB device, see <How to Set a Medium / a Device> (page 13).
- When the unit is turned on after pressing the Reset button, the Initial SETUP screen is displayed. (page 77)

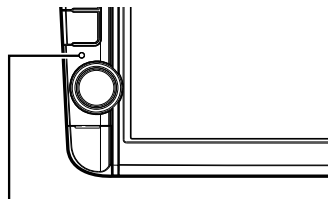

Reset button

### Cleaning the unit

If the faceplate of this unit is stained, wipe it with a dry soft cloth such as a silicon cloth.

If the faceplate is stained badly, wipe the stain off with a cloth moistened with neutral cleaner, then wipe it again with a clean soft dry cloth.



- Applying spray cleaner directly to the unit may affect its mechanical parts. Wiping the faceplate with a hard cloth or using a volatile liquid such as thinner or alcohol may scratch the surface or erase characters.

### Lens fogging

When you turn on the car heater in cold weather, dew or condensation may form on the lens in the disc player of the unit. Called lens fogging, this condensation on the lens may not allow discs to play. In such a situation, remove the disc and wait for the condensation to evaporate. If the unit still does not operate normally after a while, consult your Kenwood dealer.

### Handling discs

- Do not touch the recording surface of the disc.
- Do not stick tape etc. on the disc, or use a disc with tape stuck on it.
- Do not use disc type accessories.
- Clean from the center of the disc and move outward.
- When removing discs from this unit, pull them out horizontally.
- If the disc center hole or outside rim has burrs, use the disc only after removing the burrs with a ballpoint pen etc.

### Discs that cannot be used

- Discs that are not round cannot be used.

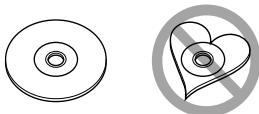

- Discs with coloring on the recording surface or discs that are dirty cannot be used.
- This unit can only play the CDs with  This unit may not correctly play discs which do not have the mark.
- You cannot play a disc that has not been finalized. (For the finalization process refer to your writing software, and your recorder instruction manual.)
- If you try to load a 3-inch-disc with its adapter into the unit, the adapter might separate from the disc and damage the unit.

### Other notes

- If you experience problems during installation, consult your Kenwood dealer.
- When you purchase optional accessories, check with your Kenwood dealer to make sure that they work with your model and in your area.
- Characters that conform to ISO 8859-1 can be displayed.
- The RDS or RBDS feature won't work where the service is not supported by any broadcasting station.

### Protecting the monitor

To protect the monitor from damage, do not operate the monitor using a ball point pen or similar tool with the sharp tip.

# Notes

## List of playable discs

Disc types	Standard	Support	Remark
DVD	DVD Video	○	
	DVD Audio	×	
	DVD-VR	○	Not compatible with CPRM.
	DVD-R	○	
	DVD-RW	○	MP3/WMA/AAC/WAV/ JPEG/MPEG/DivX Playback
	DVD+R	○	Multi-border/Multisession/ (Playback depends on authoring conditions)
	DVD+RW	○	Compatible with 8-cm (3 inch) discs
	DVD-R DL (Dual layer)	○	
	DVD+R DL (Double layer)	○	Only video format
	DVD-RAM	×	
CD	Music CD	○	CD-TEXT/8-cm (3 inch) discs supported.
	CD-ROM	○	MP3/WMA/AAC/WAV/ JPEG/DivX playback.
	CD-R	○	Multisession supported
	CD-RW	○	Packet write not supported.
	DTS-CD	○	
	Video CD (VCD)	○	
	Super video CD	×	
	Photo CD	×	
	CD-EXTRA	△	Only music CD session can be played.
	HDCD	△	Sound quality of normal CD music.
	CCCD	×	
Others	Dualdisc	×	
	Super audio CD	△	Only CD layer can be played.

○ : Playback is possible.

△ : Playback is partly possible.

× : Playback is impossible.



- When buying DRM enabled contents, check the Registration Code in the <DivX Setup> (page 58). Registration Code changes each time a file with the displayed Registration Code is played to protect against copying.

## Use of "DualDisc"

When playing a "DualDisc" on this unit, the surface of the disc that is not played may be scratched while the disc is inserted or ejected. Since the music CD surface does not conform to the CD standard, playback may be impossible.

(A "DualDisc" is a disc with one surface containing DVD standard signals and the other surface containing music CD signals.)

## About Audio files

### • Playable Audio file

AAC-LC (.m4a), MP3 (.mp3), WMA (.wma), Linear PCM (WAV) (.wav)



- If music of normal CD and other playback systems are recorded in the same disc, only the playback system recorded at the first setup is played.

### • Acceptable media

CD-R/RW/ROM, DVD±R/RW, mass-storage-class USB device, iPod with KCA-iP240V

### • Playable disc file format

ISO 9660 Level 1/2, Joliet, Romeo, Long file name.

### • Playable USB device file system

FAT16, FAT32

Although the audio files are compiled with the standards listed above, the play maybe impossible depending on the types or conditions of media or device.

### • Playing order of the Audio file

In the example of folder/file tree shown below, the files are played in the order from ① to ⑩.

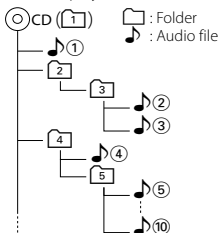

An online manual about audio files is put on the site, [www.kenwood.com/cs/ce/audiofile/](http://www.kenwood.com/cs/ce/audiofile/). On this online manual, detailed information and notes which are not written in this manual are provided. Make sure to read through the online manual as well.

## About Video files

### • Acceptable video files

MPEG1, MPEG2, DivX

### • Extensions

mpg, mpeg, m1v, m2v, divx, div, avi

### • Acceptable media

CD-R/RW/ROM, DVD±R/RW, mass-storage-class USB device, iPod with KCA-iP240V

Acceptable discs, disc formats, USB device file system, file and folder names and playing order are the same as those for audio files. See <About Audio files>.

Next page ►

## About Picture files

### • Acceptable picture files

JPEG

### • Extensions

jpg, jpeg

### • Acceptable media

CD-R/RW/ROM, DVD±R/RW, mass-storage-class  
USB device

Acceptable discs, disc formats, USB device file system, file and folder names and playing order are the same as those for audio files. See <About Audio files>.

## iPod/iPhone that can be connected to this unit

Made for

- iPod nano (1st generation)
- iPod nano (2nd generation)
- iPod nano (3rd generation)
- iPod nano (4th generation)
- iPod nano (5th generation)
- iPod classic
- iPod with video
- iPod touch (1st generation)
- iPod touch (2nd generation)

Works with



**iPhone**  
4GB 8GB 16GB



**iPhone 3G**  
8GB 16GB



**iPhone 3GS**  
16GB 32GB

- Update iPod/iPhone software to the latest version.
- You can control an iPod/iPhone from this unit by connecting an iPod/iPhone (commercial product) with Dock connector using an optional accessory iPod connection cable (KCA-iP240V). The word "iPod" appearing in this manual indicates the iPod/iPhone connected with the KCA-iP240V (optional accessory).
- By connecting your iPod/iPhone to this unit with an optional accessory iPod connection cable (KCA-iP240V), you can supply power to your iPod/iPhone as well as charge it while playing music. However, the power of this unit must be on.



- If you start playback after connecting the iPod, the music that has been played by the iPod is played first.  
In this case, "RESUMING" is displayed without displaying a folder name, etc. Changing the browse item will display a correct title, etc.
- When the iPod is connected to this unit, "KENWOOD" or "✓" is displayed on the iPod to indicate that you cannot operate the iPod.

## About USB device

- In this manual, the word "USB device" is used for flash memories and digital audio players which have USB terminals.
- When the USB device is connected to this unit, it can be charged up provided that this unit is powered.
- Install the USB device in the place where it will not prevent you from driving your vehicle properly.
- You cannot connect a USB device via a USB hub and Multi Card Reader.
- Take backups of the audio files used with this unit. The files can be erased depending on the operating conditions of the USB device.  
We shall have no compensation for any damage arising out of erasure of the stored data.
- No USB device comes with this unit. You need to purchase a commercially available USB device.
- When connecting the USB device, usage of the CA-U1EX (option) is recommended.  
Normal playback is not guaranteed when a cable other than the USB compatible cable is used.  
Connecting a cable whose total length is longer than 5 m can result in abnormal playback.

## TV tuner that can be connected to this unit

- KTC-D500E
- KTC-V300E
- KTC-V301E

## Region codes in the world

The DVD players are given a region code according to the country or area it is marketed, as shown in the following map.

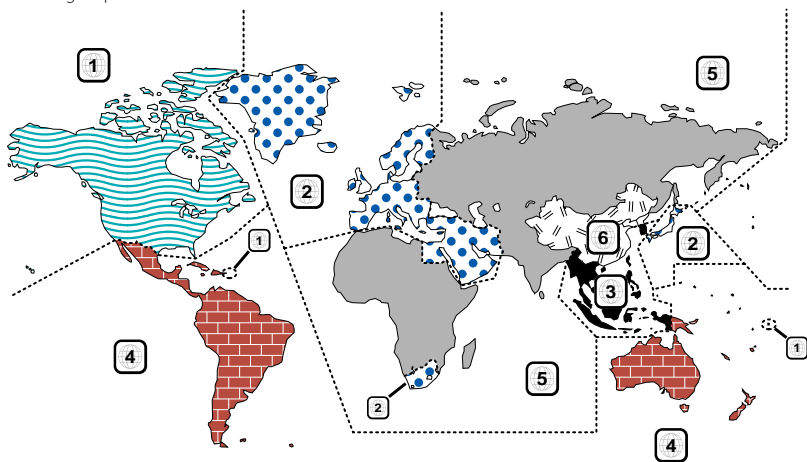

## DVD disc marks

Symbol	Description
	Indicates a region number. The discs with this mark can be played with any DVD player.
	Indicates the number of audio languages recorded. Up to 8 languages can be recorded in a movie. You can select a favorite language.
	Indicates the number of subtitled languages recorded. Up to 32 languages can be recorded.
	If a DVD disc has scenes shot from multiple angles, you can select a favorite angle.
	Indicates the type of screen for the image. The left mark indicates that a wide image picture (16:9) is displayed on a standard TV set screen (4:3) with a black band at both the top and bottom of the screen (letter box).

## Operation regulatory marks

With this DVD, some functions of this unit such as the play function may be restricted depending on the location where the DVD is playing. In this case, the following marks will appear on the screen. For more information, refer to the disc manual.



## Discs with limited period of use

Do not leave discs with a limited period of use in this unit. If you load an already expired disc, you may not be able to remove it from this unit.

# How to read this manual

This manual uses illustrations to explain its operations.

The displays and panels shown in this manual are examples used to provide clear explanations of the operations.

For this reason, they may be different from the actual displays or panels used, or some display patterns may be different.

## Selecting a screen item

Select and choose an item on the screen. Select the item by touching the button on the screen.

## Short Press

Press the button, denoted by .

## Change in the screen

With each operation, the screen changes in the order shown here.

▼ : Continues to the next line.

● : Ends here.

## Continue to the next page

The instruction continues to the next page. Make sure to flip the page for the rest of the instruction.

## Source Control Screen

Switches to the source control screen to use various functions.

### 1 Display the Source Control Screen

See <How to Display the Source Control Screen>.

### 2 Operation on the Source Control screen



[FM] Switches to the FM1/2/3 band.

[AM] Switches to the AM band.

[◀◀], [▶▶] Tunes in a station.

Use the [SEEK] to change the frequency switching.

### Multi Function



[Mono]   Selects the Monaural reception.

[SEEK] Switches the Seek mode.

The mode is switched in the following order each time you touch the button.

Display	Setting
"AUTO1"	Tunes in a station with good reception automatically.
"AUTO2"	Tunes in stations in memory one after another.
"MANU"	Switches to the next frequency manually.

### 3 Store in memory



Continue to touch until the memory number appears.

Next page ▶

The above operation example with the mark differs from the actual operation.





### Function Icon

Icons representing available functions are shown below.

 DVD-VIDEO: Function of DVD-VIDEO playback.

 DVD-VR: Function of DVD-VR playback.

 Video CD: Function of Video CD playback.

 CD: Function of CD (CD-DA) playback.

 Audio File: Function of Audio File playback.

 MPEG: Function of MPEG file playback.

 DivX: Function of DivX file playback.

 JPEG: Function of JPEG file playback.

 Disc: Function of Disc (DVD, CD) media.

 USB: Function of USB device.

 FM: Function of FM reception.

### Press 2 seconds or more

Press the button, denoted by  2sec, for 2 seconds or more.

Indicates to press and hold down the button until operation starts or the screen changes. The left example indicates to press the button for 2 seconds.

### Other marks



Important precautions are described to prevent injuries etc.



Special instructions, supplementary explanations, limitations, and reference pages are described.



General precautions and reference pages are shown on the item.



The initial value of each setup is shown.

## Functions of the buttons on the front panel

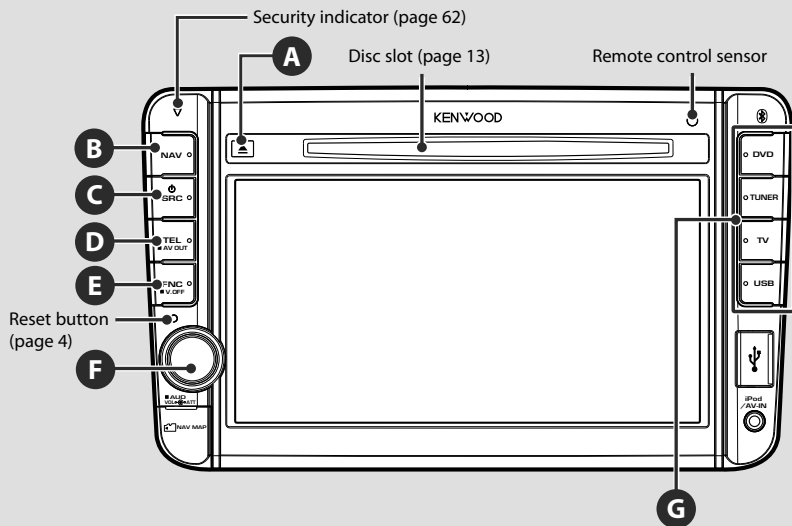

**1 sec.** : Press for more than 1 second

- A** Ejects the disc.

---

- B** Displays the navigation screen.  
When the navigation screen has already been displayed, it switches to the currently selected source screen.

---

- C** Turns the power On.  
Displays the Source Select screen. → [12](#)  
**1 sec.** Turns the power Off.

---

- D** Hands Free control screen On/Off.  
**1 sec.** Switches the source that is output at the AV OUTPUT terminal.

---

- E**
  - While watching the playback screen of a visual source  
Displays the Easy Control screen. → [17](#)
  - While watching the navigation screen  
Displays the Screen Control screen. → [41](#)
  - While watching the screen other than the above  
Screen Switching function On/Off. → [11](#)

---

- 1 sec.** Turns the display Off.\*<sup>1</sup>



\*<sup>1</sup>The function of the [FNC] button can be changed to the display off function. See <User Interface> (page 59).

- F** Volume adjustment. (Turn the knob either way.)  
 Attenuation of the volume On/Off. (Press the knob.)  
**1 sec.** Displays Tone Control screen.\*<sup>2</sup> → [55]



\*<sup>2</sup>The display may not switch to Tone Control screen in some conditions.

\*<sup>3</sup> [TV] button can be switched to [VIDEO1], and [USB] button to [iPod]. For how to assign the source to the button, refer to <User Interface> (page 59).

- G** Switches to the selected source.\*<sup>3</sup>

### Screen Switching Function

Switching between the navigation screen and the source control screen with one touch operation.

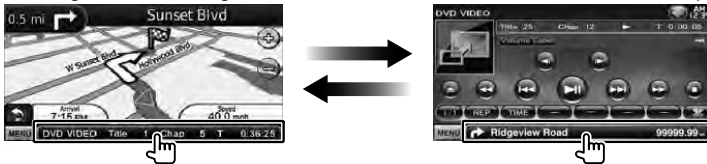

### Connecting an external device to AV-IN jack

Use of the optional cable CA-C3AV is recommended for connecting an external player. When connecting, make sure to attach the ferritic core supplied with this unit to prevent electromagnetic noise. If the ferritic core may scratch the vehicle, wrap it with the cushion sheet (Accessory of this unit).

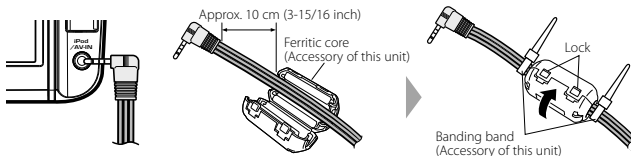

# Getting Started

## How to Display the Navigation Screen

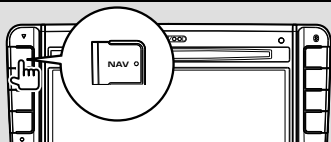

The navigation screen appears.



- For how to set up and use the navigation function, see the Navigation Instruction Manual.

## How to Select the Source

Sources can be selected from the Source Select screen.

### Source Select screen



## How to display the Source Select screen

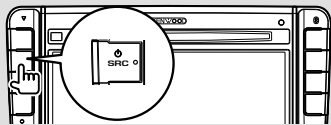

The **Source Select** screen appears.

Touch the icon of the source.

Use  $\blacktriangle$  or  $\blacktriangledown$  to turn the page.

## How to select the source by one-touch operation

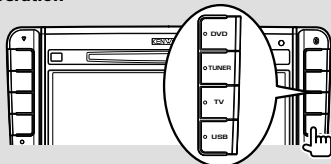

- [TV] button can be switched to [VIDEO1], and [USB] button to [iPod]. For how to assign the source to the button, refer to <User Interface> (page 59).

For how to operate each source, see the following pages.

- DVD-VIDEO/ DVD-VR/ Video CD disc ➔ Page 18
- CD ➔ Page 23
- Audio file/ Video file/ Picture file disc ➔ Page 23
- iPod ➔ Page 29
- USB ➔ Page 23
- TUNER ➔ Page 32
- TV ➔ Page 36



- For Disc media, iPod, and USB, the input is switched to the source as the media or the device is set.

## How to Set a Medium / a Device

### ■ Disc media

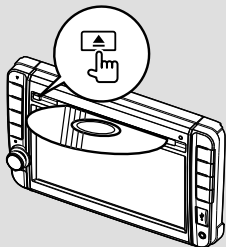

If a disc is already inserted, it is ejected by pressing the **[▲]** button.

### ■ iPod

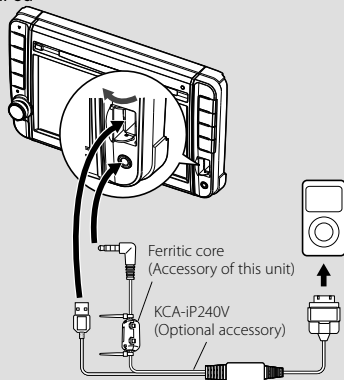

KCA-iP240V (optional accessory) is required to connect an iPod. When connecting, make sure to attach the ferritic core supplied with this unit to prevent electromagnetic noise (page 11).

To disconnect the iPod, stop the playback by touching the **[▶||]** button on the source control screen, and then disconnect the iPod. See <Source Control Screen> (page 30).

### ■ USB device

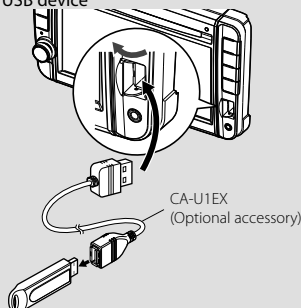

CA-U1EX (optional accessory) is required to connect a USB device.

To disconnect the USB device, touch the **[▲]** button on the source control screen, and then disconnect the USB device. See <Source Control Screen> (page 23).



- The playback starts automatically after setting the media or the device.

### ■ microSD card

This microSD card slot is used to upgrade the Navigation System.

For how to upgrade the Navigation System, refer to the instruction manual of the navigation system.

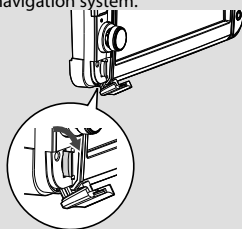

#### *Inserting the microSD card*

Hold the microSD card with the label side facing left and the notched section up, and insert it into the slot until it clicks.

#### *Removing the microSD card*

Push the microSD card until it clicks and then remove your finger from the card. The card pops up so that you can pull it out with your fingers.

# Basic Operation

## How to Display the Source Control Screen

On the Source Control screen you can find all the control buttons for the selected source.

### Source Control screen



- For how to use each button, see the operation pages of each source.

### How to display the Source Control screen

- While watching the navigation screen



The **Source Control screen** appears.



- The screen will return to the navigation screen by touching the same part of the Source Control screen.

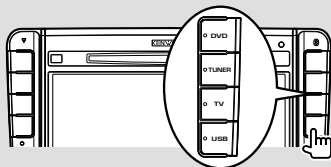

The **Source Control screen** appears.

- While watching the playback screen of a visual source

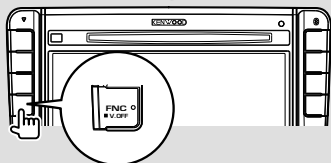

The **Source Control screen** appears.

## How to Display Top Menu Screen

Top Menu screen is the entrance to all the functions. You can enter source operation screen as well as various setup menu from this screen.

### Top Menu screen



### How to display the Top Menu screen











Touch the [MENU] button on any screen.









The **Top Menu screen** appears.

### Buttons on the Top Menu screen

- [NAV ] Switches to the navigation screen.
- [SRC ] Switches to the source control screen of the selected source. The icon of this button changes according to the selected source.
- [TEL ] Switches to the Hands Free Main screen. (page 44)
- [NAV SETUP ] Displays Navigation SETUP screen. Refer to the navigation instruction manual for setting up the navigation system.
- [SRC SETUP ] Displays SETUP Menu screen. (page 57)
- [TEL SETUP ] Displays Hands Free SETUP screen. (page 48)
- [SRC SELECT ] Displays Source Select screen. (page 12)
- [AUDIO ] Displays Audio Control Menu screen. (page 54)
- [SKIN ] Changes the screen skin each time it is pressed.

The buttons listed below are common for many screens.

- [MENU ] Displays Top Menu screen.
- [FUNCTION BAR ] Opens the function bar. The buttons shown below appear.
  - [SOURCE ] Displays the currently selected source screen.
  - [AUDIO ] Displays Audio Control Menu screen. (page 54)
  - [SETUP ] Displays SETUP Menu screen. (page 57)
  - [CLOSE ] Closes the function bar.

## Operation on the Playback Screen of Visual Sources

While watching visual sources, basic operation is possible by touching the screen.

The screen has 4 function areas. The function of each area is different depending on the sources. (Some areas are unavailable for some sources.)

### Playback screen of a visual source



#### Basic operation of each area

- 1 Reverse search.
- 2 Displays Menu control screen (DVD-VIDEO, DVD-VR source), Picture control buttons (sources with picture files), or Zoom control buttons (Video CD).  
Switches TV band.
- 3 Forward search.
- 4 Displays/ Clears Source Information screen.\*



- For the function of each touching area, see the pages of each source.

#### \* Source Information screen



- The information display is cleared automatically after approximately 5 seconds.

### How to display the playback screen

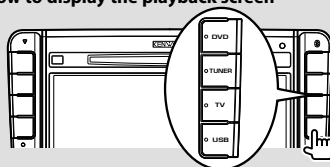

The **Playback screen of a visual source** appears.



- The playback screen may appear directly after selecting the source.



## How to Display the Easy Control Screen

Basic operation buttons of the selected source can be displayed on the playback screen of visual sources so that you can control the source without switching the screen.

### Easy Control screen



### Buttons on the Easy Control screen

- [▼] Changes the function as follows by touching the [▼] button.
  - [SCRN] Displays Screen Control screen (page 41).
  - [TEL] Switches to the Hands Free Main screen (page 44).
  - [◀◀], [▶▶], [◀◀], [▶▶], [■], [▶▶]
- Buttons for source control. The buttons are different depending on the source. See the operation pages of each source.

### While watching the visual source

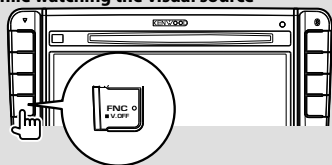

The **Easy control screen** appears.



- Easy Control screen is hidden when you touch the central part of the monitor.

# Watching DVD/Video CD

You can play DVD/Video CD using various functions.

## Playback Screen

Basic functions are available even when the playback screen is displayed.

### 1 Display the Playback Screen

See <Operation on the Playback Screen of Visual Sources> (page 16).

### 2 Operation on the Playback Screen



- 1, 3 **DVD-VIDEO** Searches for a chapter.  
**DVD-VR** Searches for a chapter.  
**Video CD** Selects a scene (when PBC is On) or a track (when PBC is Off).
- 2 **DVD-VIDEO** Displays the Menu Control 1 screen (page 20).  
**DVD-VR** Displays the Menu Control screen (page 21).  
**Video CD** Displays the Zoom Control screen (page 22).
- 4 Displays/ Clears Source Information screen.



- The information display is cleared automatically after approximately 5 seconds.

## Easy Control Screen

Displays the basic operation buttons on the screen.

### 1 Display the Easy Control Screen

See <How to Display the Easy Control buttons> (page 17).

### 2 Operation on the Easy Control Screen



- 1, 2 Switches to the Playback screen.
- 3 Displays the Source Control screen.  
[<<], [>>] Fast Forwards or Fast Backwards.  
Changes the speed (2 times, 3 times, or off) each time the button is touched.
- [<<<], [>>>] [i<<<], [>>>i]  
**DVD-VIDEO** Searches for a chapter.  
**DVD-VR** Searches for a chapter.  
**Video CD** Selects a scene (when PBC is On) or a track (when PBC is Off).
- [■] Stops playing.  
When touched twice, the disc is played from its beginning when you play it the next time.
- [▶||] Plays or pauses.

## Source Control Screen

Switches to the source control screen to use various playback functions.

### 1 Display the Source Control Screen

See <How to Display the Source Control Screen> (page 14).

### 2 Operation on the Source Control Screen



**[▶||]** Plays or pauses.

**[■]** Stops playing.

When touched twice, the disc is played from its beginning when you play it the next time.

**[▲]** Ejects a disc.

**[◀◀], [▶▶]** Fast Forwards or Fast Backwards.  
Changes the speed (2 times, 3 times, or off) each time the button is touched.

**[|◀◀], [▶▶|]**

**DVD-VIDEO** Searches for a chapter.

**DVD-VR** Searches for a chapter.

**Video CD** Selects a scene (when PBC is On) or a track (when PBC is Off).

**[◀|], [|▶]** **DVD-VIDEO**, **DVD-VR** Slow Forwards or Backwards.

**[⏏]** Switches to the playback screen.

**1** Information display  
Title display.

**"Title"** Title Number Display

**"Chap"** Chapter Number Display

**"Scene"/ "Track"** Scene/Track Number Display

**"▶"** Play Mode Display

**"T"/ "C"/ "R"/ "P"** Play Time Display  
Use the [TIME] to change play time display.

**[◀◀]** When **◀◀** appears, the text display is scrolled by touching it.

### Multi Function



**[⏏]** Closes the multi function bar.

**[⏏]** Opens the multi function bar.

### DVD-VIDEO

**[REP]** Switches the Repeat Play operations in the following sequence.

Title Repeat, Chapter Repeat, Repeat Off

**[TIME]** Switches the play time display in the following sequence.

Chapter ("C"), Title ("T"), remaining titles ("R")

### DVD-VR

**[REP]** Switches the Repeat Play operations in the following sequence.

Title Repeat, Repeat Off

**[TIME]** Switches the play time display in the following sequence.

Title ("T"), remaining titles ("R")

**[PLST]** Switches between the original mode and Play list mode.

### Video CD

**[REP]** Switches the Repeat Play operations in the following sequence.

Track Repeat, Repeat Off (Available when the PBC is off)

**[TIME]** Switches the play time display in the following sequence.

Track ("P"), remaining discs ("R") (Effective only when the PBC function is off)

**[PBC]** Turns the PBC On or Off. (only when VCD Ver 2.0 is in use)

## DVD-VIDEO Disc Menu

Selects an option from the DVD-VIDEO Disc Menu.

### 1 Display the Playback Screen

See <Operation on the Playback Screen of Visual Sources> (page 16).

### 2 Display the Menu Control 1 screen



### 3 Operation on the Menu Control 1 screen



**[Menu]** Calls the Menu.

**[Next]** Displays the Menu Control 2 screen.

**[◀], [▶], [▲], [▼]** Selects a menu option.

**[Enter]** Enters your menu selection.

**[Return]** Returns to the previous menu screen.

**[Top]** Displays the Top Menu.

**[Highlight]** Highlight Control.

**[Exit]** Exits the Menu Control 1 screen.

### 4 Operation on the Highlight Control

Highlight control lets you control DVD Menu by touching the menu button directly on the screen.



- Touching the central part of the monitor also turns on the Highlight Control.
- To cancel Highlight Control, press the [FNC] button.
- The Highlight Control is cleared automatically after approximately 10 seconds.

### 5 Operation on the Menu Control 2 screen



**[Previous]** Displays the Menu Control 1 screen.

**[Angle]** Switches the picture angle.

**[SUB]** Switches the subtitle language.

**[Audio]** Switches the voice language.

**[Zoom]** Displays the Zoom Control screen.

**[Exit]** Exits the Menu Control 2 screen.

### 6 Operation on the Zoom Control screen



**[Zoom]** Changes the zoom ratio at 4 levels (2 times, 3 times, 4 times, or off) each time you touch.

**[◀], [▶], [▲], [▼]** Scrolls the screen in the direction you touch.

**[Return]** Returns to the Menu Control 2 screen.

**[Exit]** Exits the Zoom Control screen.

## DVD-VR Menu Control

Selects an option from the DVD-VR Disc Menu.

### 1 Display the playback screen

See <Operation on the Playback Screen of Visual Sources> (page 16).

### 2 Display the Menu Control screen



### 3 Operation on the Menu Control screen



**[Zoom]** Displays the Zoom Control screen.

**[SUB]** Switches the subtitle language.

**[Audio]** Switches the voice language.

**[Exit]** Exits the Menu Control screen.

### 4 Operation on the Zoom Control screen



**[Zoom]** Changes the zoom ratio at 4 levels (2 times, 3 times, 4 times, or off) each time you touch.

**[◀], [▶], [▲], [▼]** Scrolls the screen in the direction you touch.

**[Return]** Returns to the Menu Control screen.

**[Exit]** Exits the Zoom Control screen.

## Video CD Zoom Control

Displays an enlarged VCD screen.

### 1 Display the playback screen

See <Operation on the Playback Screen of Visual Sources> (page 16).

### 2 Display the Zoom Control screen



### 3 Operation on the Zoom Control screen



**[Zoom]** Changes the zoom ratio at 2 levels (2 times or off) each time you touch.

**[◀], [▶], [▲], [▼]** Scrolls the screen in the direction you touch.

**[Exit]** Exits the Zoom Control screen.

# Music Disc/ Audio File Listening & Video File/ Picture File Watching

You can recall various control screens during playback of CD, audio file, video file and picture file.

- See <List of playable discs> (page 5) for playable discs.
- See <About Audio file> (page 5), <About Video files> (page 5) or <About Picture files> (page 6) for playable files.

## Source Control Screen

Switches to the source control screen to use various playback functions.

### 1 Display the Source Control Screen

See <How to Display the Source Control Screen> (page 14).

### 2 Operation on the Source Control Screen



[▶||] Plays or pauses.

[■] [Disc] Stops playing.

When touched twice, the disc is played from its beginning when you play it the next time.

[▲] [Disc] Ejects the disc.

[USB] Disables the USB device.

When "No Device" is shown, the USB device can be removed safely.

If you wish to play it again while the USB device is connected, touch it again.

[<<<], [>>>] [CD], [Audio File], [MPEG/DvX], [JPEG] Fast Forwards or Fast Backwards.

[|<<], [>>|] Selects a track/ file.

[<], [>] [Audio File], [MPEG/DvX], [JPEG] Selects a folder.

[List] [Audio File], [MPEG/DvX], [JPEG]

Displays the folder list or play list. (page 24)

[▶] Switches to the playback screen.

1 Information display

[CD] Selects the Disc Text or Track Text.

[Audio File], [MPEG/DvX], [JPEG] Selects Folder Name, File Name, Title, Artist Name, or Album Name.

"Track" Track Number Display

"# " Folder Number Display

"# " File Number Display

"#### / ####" Total number of file in the folder and the file number display

"▶" Play Mode Display

"P"/ "R" Play Time Display

Use the [TIME] to change play time display.

[<<<] When <<< appears, the text display is scrolled by touching it.

## Multi Function



[1/2] Switches the multi function display.

[■] Closes the multi function bar.

[<>] Opens the multi function bar.

[CD]

[REP] Repeats the present track.

[RDM] Starts or stops Random Play (to play music in random order).

[TIME] Switches the play time display between Track ("P"), and Disc Remaining Time ("R").

Next page ▶



**[REP]** Repeats the present file or data.

**[FREP]** Repeats the music or data of the present folder.

**[RDM]** Starts or stops Random Play (to play files of the present folder in random order). Not available if there are only picture files.

**[4Line]/ [2Line]** Switches the number of lines displayed in the Information Display.

**[FOLD]/ [FLIST]** Displays the folder list.

**[PLIST]** in Displays the play list.

**[SLIDE]** Displays images in the folder currently being played one after another.

If there is no image in the folder currently being played, initial background is displayed. For information on setting the image display time, see <Disc Setup> (page 74) or <USB Setup> (page 75).

**[INFO]** Displays music information (such as Tag and content property) of Audio file being played.

Displays information of file being played.

**[LINK]** in Searches for another song of the currently selected artist. See <Link Search> (page 26).

**[Device]** Selects the connected USB device (or a partition). See <USB Device Select> (page 25).

## List Select

**Folder list:** Searches folders and Audio/ Video/ Picture files stored in media and devices according to hierarchy.

**Play list:** Lists and searches music contained in the USB device.

### 1 Display the Source Control Screen

See <Source Control Screen> (page 23).

### 2 Start List Select



- Touching [List] displays the previously used Folder list or Play list.

### 3 Select a file



- 1 Folder opens when touched, and the files in the folder are played.

**[◀]** When appears, the text display is scrolled by touching it.

**[↑ ROOT]** Moves to the top hierarchy level.

**[↑ TOP]** Moves up a hierarchy level.

**[↑ USB]** Moves to the top folder.

**[CUR]** Displays the currently playing folder.

**[CTRL]** Returns to the Source Control screen.



## Play list Audio File in USB



1 Switches to the lower level of the category.

[◀] When ◀ appears, the text display is scrolled by touching it.

[▶ ALL] Lists all the music in the selected category.

[↑ UP] Moves to the upper level of the category.

[↑ TOP] Moves to the top category.

[🎵 CUR] Displays the currently playing category.

[CTRL] Returns to the Source Control screen.

## Scrolls to the position of the specified initial



Scrolls to the selected initial.

## USB device select

Selects the connected USB device (or a partition).

### 1 Display the Source Control Screen

See <Source Control Screen> (page 23).

### 2 Display the USB Device Select Screen



### 3 Select a USB device



1 Selects a device or partition.

[↑ UP] Returns to the Device Selection screen.

[◀] When ◀ appears, the text display is scrolled by touching it.

[CTRL] Returns to the Source Control screen.

### Link search (Audio file in USB)

Searches for another song of the currently selected artist.

#### 1 Display the Source Control Screen

See <Source Control Screen> (page 23).

#### 2 Start Link search



#### 3 Select a song



1 Plays the touched song.

[◀] When ◀ appears, the text display is scrolled by touching it.

[↑ TOP] Moves to the top category.

[CUR] Displays the currently playing category.

[CTRL] Returns to the Source Control screen.

#### Scrolls to the position of the specified initial



Scrolls to the selected initial.

### Playback Screen (Video file, Picture file)

Basic functions are available even when the playback screen is displayed.

#### 1 Display the Playback Screen

See <Operation on the Playback Screen of Visual Sources> (page 16).

#### 2 Operation on the Playback Screen



1, 3 Searches for a file.

2 [JPG] Displays the Picture Control screen (page 27).

[MPG DivX] Displays the Menu Control screen (page 28).

4 Displays/ Clears Source Information screen.



- The information display is cleared automatically after approximately 5 seconds. Also, the information can be displayed automatically when it is updated.

## Easy Control Screen (Video file, Picture file)

Displays the basic operation buttons on the screen.

### 1 Display the Easy Control Screen

See <How to Display the Easy Control Screen> (page 17).

### 2 Operation on the Easy Control Screen



[1], [2] Switches to the Playback screen.

[3] Displays the Source Control screen.

[<<], [>>] [JPEG, MPEG DivX]  
Fast Forwards or Fast Backwards.

[<<<], [>>>] Searches for a file.  
During the slide show of picture files, touching the buttons searches the audio file.

[■] [Disc] Stops playing.

When touched twice, the disc is played from its beginning when you play it the next time.

[▶||] Plays or pauses.

## Picture Control

Adjusting the picture display.

### 1 Display the Playback Screen

See <Operation on the Playback Screen of Visual Sources> (page 16).

### 2 Display the Picture Control Screen



### 3 Adjust the picture display



[↑↓] Reverses the picture horizontally.

[↻] Rotates counter clockwise.

[↻] Rotates clockwise.

[Exit] Ends Picture Control.

## Movie Menu Control

Selects an option from the Movie Menu.

### 1 Display the playback screen

See <Operation on the Playback Screen of Visual Sources> (page 16).

### 2 Display the Menu Control screen



### 3 Operation on the Menu Control screen



**[SUB]** Switches the subtitle language.

**[Audio]** Switches the voice language.

**[Exit]** Exits the Menu Control screen.

# iPod Control

You can control and listen to songs in your iPod by connecting an iPod to this unit with KCA-iP240V (optional accessory). You can also display video contents on this unit when connecting an iPod with video.

## Playback Screen

Basic functions are available even when the playback screen is displayed.

### 1 Display the Playback Screen

See <Operation on the Playback Screen of Visual Sources> (page 16).

### 2 Operation on the Playback Screen

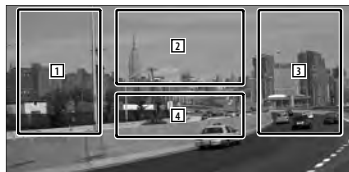

- 1, 3 Selects the music/video.
- 2 Not effective
- 4 Displays/ Clears Source Information screen.



- The information display is cleared automatically after approximately 5 seconds. Also, the information can be displayed automatically when it is updated.
- Remove all accessories such as headphone before connecting an iPod. You may not be able to control the iPod if you connect it with accessories attached.
- When you connect an iPod to this unit, playback starts from the song you were playing on the iPod itself (Resume Function).
- If the played song is not a video content, "No Video Signal" is displayed on the video screen.

## Easy Control Screen

Displays the basic operation buttons on the screen.

### 1 Display the Easy Control Screen

See <How to Display the Easy Control Screen> (page 17).

### 2 Operation on the Easy Control Screen



- 1, 2 Switches to the Playback screen.
- 3 Displays the Source Control screen.
- [<<], [>>]] Fast Forwards or Fast Backwards.
- [<<<], [>>>]] Music/Video Search.
- [>>||] Plays or pauses.

## Source Control Screen

Switches to the source control screen to use various playback functions.

### 1 Display the Source Control Screen

See <How to Display the Source Control Screen> (page 14).

### 2 Operation on the Source Control Screen



**[▶||]** Plays or pauses.

**[<<], [>>]** Fast Forwards or Fast Backwards.

**[<-<], [>>>]** Selects Music/Video.

**[List]** Displays the iPod list. (page 31)

**[▶]** Switches to the playback screen.

**[i]** Information display  
Selects the Title, Artist Name, Album Name or iPod Name.

"##### / #####" Total number of music in the iPod and the music number display

"▶" Play Mode Display

"P" Play Time Display

**[◀◀]** When ◀◀ appears, the text display is scrolled by touching it.

## Multi Function



**[1/2]** Switches the multi function display.

**[▶]** Closes the multi function bar.

**[▶]** Opens the multi function bar.

**[MUSIC]** Displays the list of music category.

**[VIDEO]** Displays the list of video category.

**[REP]** Repeats the present file or data.

**[RDM]\*** Starts or stops Random play.

**[ARDM]\*** Starts or stops Album Random Play (plays randomly from current album).

**[INFO]** Displays information screen of music/video being played.

**[LINK]\***  Searches for another song of the currently selected artist. See <Link Search> (page 31).



\* Disabled when VIDEO is being played.

## iPod List

Lists and searches music/video contained in the iPod.

### 1 Display the Source Control Screen

See <Source Control Screen> (page 30).

### 2 Display the iPod List



### 3 Select music/video



#### 1 Categories and music are listed.

Touch a category name to move to its lower level. If music title is displayed, the music is played by touching it.

When **▶||** is appeared, all the music in its category is played by touching the button.

[◀] When ◀ appears, the text display is scrolled by touching it.

[↑] UP Returns to previous category.

[↑] TOP Moves to the top category.

[CUR] Displays the currently playing category.

[CTRL] Returns to the Source Control screen.

### Scrolls to the position of the specified initial



Scrolls to the selected initial.

## Link Search (Music file)

Searches for another song of the currently selected artist.

### 1 Display the Source Control Screen

See <Source Control Screen> (page 30).

### 2 Start Link search



### 3 Select a song



#### 1 Plays the touched song.

[◀] When ◀ appears, the text display is scrolled by touching it.

[↑] TOP Moves to the top category.

[CUR] Displays the currently playing category.

[CTRL] Returns to the Source Control screen.

### Scrolls to the position of the specified initial



Scrolls to the selected initial.

# Radio Listening

Various control screens appear in the Tuner Source mode.

## Source Control Screen

Switches to the source control screen to use various functions.

### 1 Display the Source Control Screen

See <How to Display the Source Control Screen> (page 14).

### 2 Operation on the Source Control Screen



**[FM]** Switches to the FM1/2/3 band.

**[AM]** Switches to the AM band.

**[TI]** Turns the Traffic Information function On or Off.  
See <Traffic Information>, (page 35).

**[◀▶]** Tunes in a station.  
Use the [SEEK] to change the frequency.

**[List]** Display the Tuner Preset List screen. See <Preset Select> (page 33).

1 Information display  
Selects the Program Service Name, Title & Artist name, Station Name, Radio Text Plus, or Radio Text.

"FM"/ "AM" Band display

"Preset" Preset number

"MHz"/ "kHz" Frequency display

**[◀▶]** When ◀▶ appears, the text display is scrolled by touching it.

## Multi Function



**[1/3]** Switches the multi function display.

**[◀▶]** Closes the multi function bar.

**[▶▶]** Opens the multi function bar.

**[P1] – [P6]** When [P1] to [P6] buttons appear, you can recall the stations on memory. For memory of broadcasting stations, see <Auto Memory> (page 33) or <Manual Memory> (page 34).

**[SEEK]** Switches the Seek mode.  
The mode is switched in the following order each time you touch the button.

Display	Setting
"AUTO1"	Tunes in a station with good reception automatically.
"AUTO2"	Tunes in stations in memory one after another.
"MANU"	Switches to the next frequency manually.

**[AME]** Selects the Auto Memory mode.  
See <Auto Memory> (page 33).

**[PRE]** Lists and selects memorized station.

**[4Line]/ [2Line]** Switches the number of lines displayed in the Information Display.

**[PTY]** Searches station by program type.  
See <Search by Program Type> (page 35).

**[Mono]** Selects the Monaural reception.

**[LO.S]** Turns the Local Seek function ON or OFF.

**[TEXT]** Displays Radio Text screen.  
See <Radio Text> (page 34).



## Preset Select

Lists and selects memorized station.

### 1 Display the Source Control Screen

See <Source Control Screen> (page 32).

### 2 Display the Tuner Preset List Screen



### 3 Select a station



1 Memorized stations are displayed. Touch to tune in.

[CTRL] Returns to the Source Control screen.

## Auto Memory

Stores stations with good reception in memory automatically.

### 1 Display the Source Control Screen

See <Source Control Screen> (page 32).

### 2 Select a band you wish to store in memory



### 3 Select the Auto Memory mode



### 4 Start Auto Memory



Auto Memory terminates when 6 stations are stored or when all stations are tuned in.



- The operation ends automatically if you do not operate within 10 seconds.

## Manual Memory

Stores the current receiving station in memory.

### 1 Display the Source Control Screen

See <Source Control Screen> (page 32).

### 2 Select a station you wish to store in memory



### 3 Store in memory



Continue to touch until the memory number appears.

## Radio Text

You can display the radio text. (Only when receiving the FM broadcast)

### 1 Select a station

See <Source Control Screen> (page 32).

### 2 Display the radio text



[1] Selects the Program Service Name, Title & Artist name, Station Name, Radio Text Plus, or Radio Text for text display.

[◀] When ◀ appears, the text display is scrolled by touching it.

[▲], [▼] Scrolls the text display.

## Traffic Information

When a traffic bulletin starts, any source is switched to the traffic information and it is displayed automatically.

### 1 Display the Source Control Screen

See <Source Control Screen> (page 32).

### 2 Set the Traffic information mode



### When the traffic bulletin starts...

The Traffic Information screen appears automatically.

### Traffic Information screen



- It is necessary to have Traffic Information function set to On in order to have the Traffic Information screen appear automatically.
- During the reception of traffic information the adjusted volume is automatically remembered, so that the next time it switches to traffic information the volume level is that from the previously adjusted and remembered level.

## Search by Program Type

A program is tuned when you set its program type. (Only when receiving the FM broadcast)

### 1 Display the Source Control Screen

See <Source Control Screen> (page 32).

### 2 Enter Program Type Search mode



### 3 Select a Program Type



- 1 Program Type is displayed. Touch to select a Program Type.

[Search] Searches for the program type. It is displayed when the Program type is selected.

### 4 Search a station of the selected Program Type



# TV Watching

Various control screens appear in the TV source mode. You can only operate TV with the optional accessory TV Tuner connected.

## Function During TV Screen

Basic functions are available even when the TV screen is displayed.

### 1 Display the TV screen

See <Operation on the Playback Screen of Visual Sources> (page 16).

### 2 Operation on the TV screen



- 1, 3 Selects a channel.
- 2 Switches to TV1 or TV2.
- 2 Displays Menu Control screen (only with KTC-D500E (optional accessory) connected (page 37).
- 4 Displays/ Clears Source Information screen.



- The information display is cleared automatically after approximately 5 seconds. Also, the information can be displayed automatically when it is updated.

## Easy Control Screen

Displays the basic operation buttons on the screen.

### 1 Display the Easy Control Screen

See <How to Display the Easy Control Screen> (page 17).

### 2 Operation on the Easy Control Screen

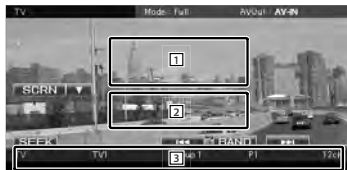

- 1, 2 Switches to the TV screen.
  - 3 Displays the Source Control screen.
- [BAND]** Switches to TV1 or TV2.
- [←], [→]** Selects a channel.  
Use the **[SEEK]** to change the channel tuning sequence.
- [SEEK]** Switches the Seek mode. (page 37)

## Source Control Screen

Switches to source control screen to use various functions.

### 1 Display the Source Control Screen

See <How to Display the Source Control Screen> (page 14).

### 2 Operation on the Source Control Screen



**[BAND]** Switches to TV1 or TV2.

**[◀▶], [▶▶], [◀◀]** Select a channel.

Use the **[SEEK]** to change the channel tuning sequence.

**[List]** Display the TV Preset List screen. (page 39).

**[TV]** Switches to the TV screen.

**1** Information display

Channel information display

"TV" Band display

"Group" TV Area Group Display. See <TV Setup> (page 76).

"Preset" Memory Number Display

"ch" Channel display

**[◀◀]** When ◀◀ appears, the text display is scrolled by touching it.

### Multi Function



**[1/2]** Switches the multi function display.

**[TV]** Closes the multi function bar.

**[TV]** Opens the multi function bar.

**[P1] – [P6]** When [P1] to [P6] buttons appear, you can recall channels on memory.

For memory of broadcasting stations, see <Auto Memory> (page 38) or <Manual Memory> (page 38).

**[AME]** Selects the Auto Memory mode. See <Auto Memory> (page 38).

**[SEEK]** Switches the Seek mode. The mode is switched in the following order each time you touch the button.

Display	Setting
"AUTO1"	Tunes in a station with good reception automatically.
"AUTO2"	Tunes in stations in memory one after another.
"MANU"	Switches to the next frequency manually.

**[PRE]** Lists and selects memorized station.

**[NAME]** Sets a name to the station. See <Set Station Name> (page 39).

## TV Menu (only with KTC-D500E (optional accessory) connected)

Menu Control screen appears by touching the area shown below.

### 1 Display the TV screen

See <Operation on the Playback Screen of Visual Sources> (page 16).

### 2 Display the Menu Control screen



### 3 Operation on the Menu Control screen

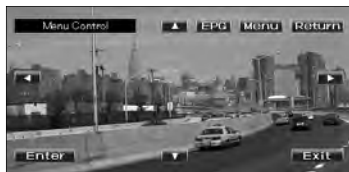

**[Menu]** Shows Digital TV Broadcasting menu screen.

**[EPG]** Shows EPG (Electric Program Guide) screen.

**[◀], [▶], [▲], [▼]** Moves highlight in Digital TV Broadcasting menu.

Next page ▶

[Enter] Executes selected menu item.

[Return] Returns to the previous screen.

[Exit] Returns to Digital TV screen.



- When using the remote control unit to operate the TV menu, use the one of KTC-D500E.

### Auto Memory (only with KTC-V300E or KTC-V301E (optional accessory) connected)

Stores stations with good reception in memory automatically.

#### 1 Display the Source Control Screen

See <Source Control Screen> (page 37).

#### 2 Select a band you wish to store in memory



#### 3 Select the Auto Memory mode



#### 4 Start Auto Memory



Auto Memory terminates when 6 stations are stored or when all stations are tuned in.



- The operation ends automatically if you do not operate within 10 seconds.

### Manual Memory (only with KTC-V300E or KTC-V301E (optional accessory) connected)

Stores the current receiving channel in memory.

#### 1 Display the Source Control Screen

See <Source Control Screen> (page 37).

#### 2 Select a station you wish to store in memory



#### 3 Store in memory



Continue to touch until the memory number appears.

## Preset Select

Lists and selects memorized station.

### 1 Display the Source Control Screen

See <Source Control Screen> (page 37).

### 2 Start Preset Select



### 3 Select a station



1 Memorized stations are displayed. Touch to tune in.

Switches to the TV screen.

[CTRL] Returns to the Source Control screen.

## Set Station Name

Assigns a name to a station.

### 1 Tune in to the station to name

See <Source Control Screen> (page 37).

### 2 Start Name set



### 3 Enter the name

See <Character Entry> (page 40) for information on how to enter a name.

### 4 End Name set



## Character Entry

### Character Entry screen

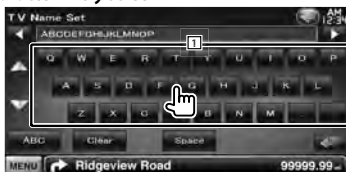

**[1]** Enters characters.

**[←], [→]** Shifts the cursor.

**[▲], [▼]** Scrolls up or down the character button display.

**[QWE]/ [ABC]** Sets the key layout of the character buttons.

ABC : Alphabetical key layout.

QWE : Qwerty key layout.

**[Clear]** Clears the character.

If you erase a character, locate the cursor on it and touch this button.

If touched more than 1 second, all the input characters are erased.

**[Space]** Enters a space.



- You can enter characters only after you have applied the parking brake.

## Muting Audio Volume upon Reception of Phone Call

### When a telephone call is received...

The Phone Call ("CALL") screen appears, and system is paused.

### Phone Call ("CALL") screen

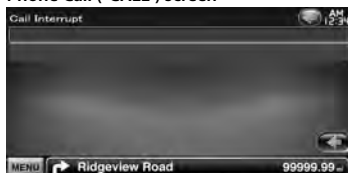

### When the call ends...

#### Hang up the phone.

The system resumes playing automatically.



- To use the TEL Mute feature, you need to hook up the MUTE wire to your telephone using a commercial telephone accessory. Refer to <INSTALLATION MANUAL>.
- Playback of the source output at the AV OUTPUT port may not be paused even a call comes in.



# Screen Control

Setting the monitor screen.

## Screen Control

### 1 Display the Easy Control Screen

See <How to Display the Easy Control Screen> (page 17).

### 2 Display the Screen Control Screen



### 3 Adjust the picture quality



**[Bright]** Brightness Control

**[Tint]** Tint Control

Displayed for an NTSC system image on Video, iPod, TV or Rear View Camera.

**[Color]** Color Control

Displayed on Video, iPod, TV or Rear View Camera screen only.

**[Contrast]** Contrast Control

**[Black]** Black Level Adjustment

**[Sharpness]** Sharpness control

Displayed on Video, iPod, USB, TV or Rear View Camera screen only.

**[Dimmer]** Dimmer Mode Setup

"ON": The display dims.

"OFF": The display doesn't dim.

"SYNC": Turning the Dimmer function On or Off when the vehicle light control switch is turned On or Off.

"NAV-SYNC": Turning the Dimmer function On or Off according to the Navigation Day/Night display setting.

**[Mode]** Selects a screen mode.

You can select any of the following screen mode.

"Full", "Just", "Zoom", "Normal"



- The Screen Control screen is displayed only when you have applied the parking brake.
- The picture quality can be set for each source.
- You can set image quality of screens such as menu from <Screen Adjustment> (page 66).

#### Full picture mode ("Full")

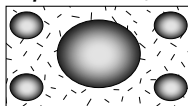

#### Justify picture mode ("Just")

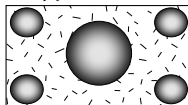

#### Zoom picture mode ("Zoom")

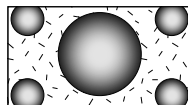

#### Normal picture mode ("Normal")

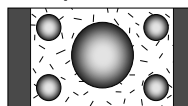

# Hands-Free Phoning

Various functions can be used in the Hands Free control mode.

## Before Use

- You need to register your cell-phone before using it with this unit. For more details, see <Registering Bluetooth unit> (page 66).
- If you have registered two or more cell-phones, you need to select one of them. For more details, see <Bluetooth Unit Connection> (page 68).
- To use the Phone Book, it must be downloaded to this unit in advance. For details, see <Downloading the Phonebook> (page 42).
- The units supporting the Bluetooth function have been certified for conformity with the Bluetooth Standard following the procedure prescribed by Bluetooth SIG. However, it may be impossible for such units to communicate with your cell-phone depending on its type.
- For the cell-phones verified for compatibility, access the following URL:  
<http://www.kenwood.com/cs/ce/bt/>
- Sound output speaker can be set. See <Bluetooth Hands-Free/Audio Output Setup> (page 69).

## Downloading the Phonebook

Downloads the phonebook data from the cell-phone to this unit so that you can use the Phonebook of this unit.

### 1 By operating the cell-phone, send the phonebook data to this unit

### 2 By operating the cell-phone, start the hands-free connection



- For the cell-phones which support auto-download of phonebook:  
If the phonebook is not downloaded automatically for some reasons, follow the procedure above to download manually.
- For how to operate the cell-phone, refer to the Instruction Manual that comes with your cell-phone.
- Up to 1000 phone numbers can be registered for each registered cell-phone.
- Up to 25 digits can be registered for each phone number along with up to 50\* characters representing a name. (\* 50: Number of alphabetical characters. Fewer characters can be input depending on the type of characters.)
- Depending on the type of your cell-phone, the following restrictions are placed:
  - The phonebook data cannot be downloaded normally.
  - Characters in the Phonebook are garbled.
  - The phonebook data cannot be downloaded normally if it contains images. It may take several hours to a full day to download the phone book depending on the total image size.
- To cancel downloading of the phonebook data, operate the cell-phone.

## Receiving a Call



- [📞] Answering a Phone Call
- [📞] Rejecting an Incoming Call



- While monitoring the rear view camera, this screen is not displayed even a call comes in. To display this screen, press the [TEL] button or return the shift knob of car to the drive position.

## During a Call



- [🔊 ↔ 📞] Switches the voice output between phone and speaker.
- [DTMF] Outputs dial tone. See <Controlling Tone-based Services> (page 47).
- [📞] Disconnecting a call

## Call Waiting



- [📞] • Answering another incoming call with the current call suspended
- Switching between the current call and waiting call  
Each touch of this button switches the calling party.
- [📞] • Answering another incoming call after terminating the current call
- Answering the waiting call after terminating the current call

## Making a Call

Displaying the control screen and using various functions.

### 1 Display the Hands-Free Control screen

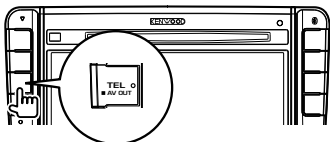

### 2 Select a dialing method

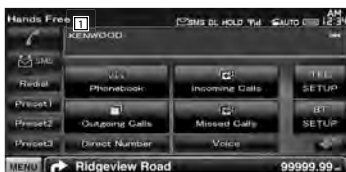

**1** Calls the displayed phone number. If you have registered a phone number in the Phonebook, the destination person name is displayed.

**[** Calls the displayed phone number.

**[Redial]** Displays the previously called phone number.

**[Preset1], [Preset2], [Preset3]** Displays the preset phone number.

For information on how to preset a phone number, see <Phone Number Preset> (page 51).

**[ Phonebook]** Displays the Search for Phonebook screen. See <Calling by Phonebook> (page 45).

**[ Outgoing Calls]** Displays the Outgoing Calls screen. See <Making a Call Using Call Records> (page 46).

**[ Incoming Calls]** Displays the Incoming Calls screen. See <Making a Call Using Call Records> (page 46).

**[ Missed Calls]** Displays the Missed Calls screen. See <Making a Call Using Call Records> (page 46).

**[Direct Number]** Displays the Dialing Display screen. See <Calling by Entering a Phone Number> (page 45).



**[Voice]** Starts voice recognition.

See <Calling by Voice Recognition> (page 46).

**[BT SETUP]** Displays the Bluetooth SETUP screen. See <Registering Bluetooth Unit> (page 66).

**[TEL SETUP]** Displays the Hands Free Setup screen. See <Setting Up the Hands-Free Phone> (page 48).



- While your car is moving, some functions are disabled due to safety reasons. The buttons associated with the disabled functions become ineffective if pressed.
- When the Hands-Free Control screen appears, the name of the connected cell-phone is displayed for 5 seconds.
- The status icons such as  and  displayed on the control unit may discord from those displayed on the cell-phone.
- Setting the cell-phone in the private mode can disable the hands-free function.

## Calling by Phonebook

You can call a person using his/her phone number that you have registered in the Phonebook.

### 1 Display the Hands-Free Control screen

See <Making a call> (page 44).

### 2 Display the Phonebook screen



### 3 Select the name to call



- 1 Phonebook data list.
- 2 Displays the Phonebook beginning with the name whose first character you have touched.

[◀] When ◀ appears, the text display is scrolled by touching it.

### 4 Select the phone number to call

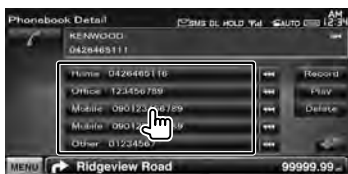

### 5 Make a call



- This function is unavailable while driving.
- To use the Phonebook, it must have been downloaded from the cell-phone. For more details, see the instruction manual of your Bluetooth Unit and your cell-phone.
- Initials including no corresponding name will not be displayed.
- During search, a non-accent character such as "u" is searched for instead of an accent character such as "ü".

## Calling by Entering a Phone Number

Makes a call by entering a phone number.

### 1 Display the Hands-Free Control screen

See <Making a call> (page 44).

### 2 Display the number input screen



### 3 Enter a phone number



- 1 Enters the desired phone number using the keypad.

[Clear] Clears the number.

### 4 Make a call



Press the green phone icon to dial the entered phone number.



- You can input up to 25 digits.
- This function is unavailable while driving.

## Making a Call Using Call Records

Calls by selecting a phone number from the outgoing, incoming, or missed calls list.

### 1 Display the Hands-Free Control screen

See <Making a call> (page 44).

### 2 Display the Outgoing Calls, Incoming Calls, or Missed Calls screen



### 3 Select from calls list

Example : Outgoing Calls screen

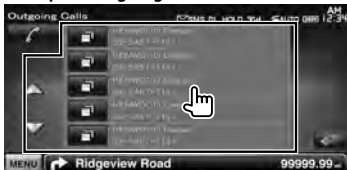

Calls the selected phone number.

### 4 Make a call



- The Outgoing Calls list screen, Incoming Calls list, or Missed Calls list screen shows the list of the calls originated from or received at this unit. They are not the ones stored in the cell-phone memory.

## Calling by Voice Recognition

Calls by recognizing the registered voice.



- In order to perform voice recognition, voice must be registered in the Phonebook data. See <Voice Registration> (page 49). Or, to perform voice recognition by Phone number category (Home, Office, Mobile etc.) of Phonebook data, a key word voice must be registered. See <Key Word Voice Registration> (page 50).

### 1 Display the Hands-Free Control screen

See <Making a call> (page 44).

### 2 Display the Voice Recognition screen



- If there is only one phone number assigned under the registered name

### 3 Say the name registered in the Phonebook



When a beep is heard, say the name within 2 seconds.

### 4 Make a call



- If there are more than one phone numbers assigned under the registered name

## 5 Say the key word registered for the category



When a beep is heard, say the key word within 2 seconds.

## 6 Make a call



- If there are more than one phone numbers registered under the same name, go to step 7.

## 7 Select a Phone number category

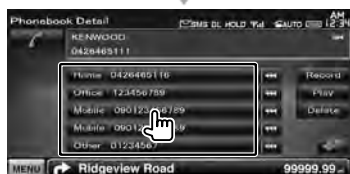

Selects the Phone number category.

## 8 Make a call



- A message is displayed if the voice is not recognized. Read the message for the further operation.

## Controlling Tone-based Services

Uses tone base service using DTMF (Dual Tone Multi Frequency).

### 1 Display the Talking screen

See <Calling by Entering a Phone Number> (page 45).

### 2 Display the DTMF input screen



### 3 You can send tones during a call



## Setting Up the Hands-Free Phone

The Hands-Free system can be set as follows.

### 1 Display the Hands-Free Control screen

See <Making a call> (page 44).

### 2 Display the Hands Free Setup screen



### 3 Set each item



**[Auto Response]** Sets an automatic response time to pick-up an incoming call.

(☑ "OFF")

"OFF": This function is disabled.

"0-99": Sets the incoming call ringing duration (in seconds).

**[Call Beep]** Sets the beep of the incoming call.

(☑ "ON")

"ON": Beep is heard.

"OFF": Beep is canceled.

**[SMS Receive Beep]** Sets the beep of the incoming SMS. (☑ "ON")

"ON": Beep is heard.

"OFF": Beep is canceled.

**[Phone Information Use]** Sets whether to use cell-phone phonebook, outgoing calls list, incoming calls list and missed calls list.

(☑ "ON")

"ON": Yes.

"OFF": No.

**[SMS Use]** Sets the SMS function. (☑ "ON")

"ON": Use SMS function.

"OFF": SMS not available.

**[Key Word]** Registers the voice to select phone number category with voice recognition.

See <Key Word Voice Registration> (page 50).

**[Use Phone Voice Recognition]**

Sets whether to dial using the phone voice recognition function. (☑ "ON")

**[Echo Cancel Level]** Adjusts the level of echo cancelling function. (☑ "15")

**[Microphone Level]** Adjusts the sensitivity of the microphone for a telephone call. (☑ "8")

**[Noise Reduction Level]** Adjusts the level of the noise reduction and the quality of the resulting speech signal. (☑ "4")

**[Restore]** Restores the [Echo Cancel Level], [Microphone Level], or [Noise Reduction Level] value to the initial value.



- Either the time interval for automatic answer set on this unit or the time interval set on the cell-phone, whichever is shorter, takes effect.



## Voice Registration

Registers voice for voice recognition in Phonebook. Up to 35 voices can be recorded in one cell-phone.

### 1 Display the Phonebook Detail screen

Go through the procedure of <Calling by Phonebook> (page 45).

### 2 Select the name to register



1 Selects a name.

**[Record]** Registers the voice for voice recognition to the selected Phonebook. If there are already 35 voice tags registered in the same cell-phone, the [Record] button is deactivated.

**[Play]** Plays the voice registered in the selected Phonebook data.

**[Delete]** Deletes the voice registered in the selected Phonebook data. Touch to display the confirmation screen. Touch [Yes] to delete or [No] to cancel.

### 3 Display the voice registration screen



### 4 Say the name to register (1st try)

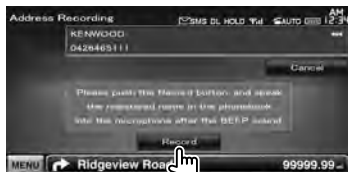

Say within 2 seconds after the Beep.

### 5 Say the name to register (2nd try)

Say within 2 seconds after the Beep.

### 6 End voice registration



- A message is displayed if the voice is not recognized. Read the message for the further operation.
- Repeat from 1st try if the voice is different from the 1st try.

## Key Word Voice Registration

Registers the voice to select the Phone number category by Voice Recognition.

### 1 Display the Hands Free Setup screen

See <Setting Up the Hands-Free Phone> (page 48).

### 2 Display the Key Word List screen

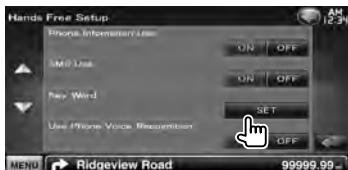

### 3 Select the Phone number category to register

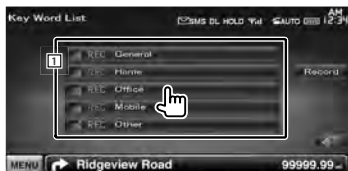

1 Selects the Phone number category. "REC" turns on for data with voice for voice recognition already registered.

[Record] Registers voice for the selected Phone number category.

### 4 Display voice registration screen



### 5 Say the phone category to register (1st try)



Say within 2 seconds after the Beep.

### 6 Say the phone category to register (2nd try)

Say within 2 seconds after the Beep.

### 7 End voice registration



- A message is displayed if the voice is not recognized. Read the message for the further operation.
- Repeat from 1st try if the voice is different from the 1st try.

## Phone Number Preset

Registers frequently used phone number to Hands Free control screen preset button.

### 1 Display the Hands-Free Control screen

See <Making a call> (page 44).

### 2 Select the Preset number to register



1 sec.



- If no Preset number is registered, pressing this button momentarily moves to the step 3.

### 3 Select the search destination of the number to register



[SMS] Registers from SMS received message list.

[SMS] Registers from SMS sent message list.

[Phonebook] Registers from Phonebook.

[Outgoing Calls] Registers from outgoing calls list.

[Incoming Calls] Registers from incoming calls list.

[Missed Calls] Registers from missed calls list.

[Direct Number] Registers by entering phone numbers.

[Voice] Registers voice for voice recognition to preset number.

[Memory] Registers the currently displayed phone number.

[Delete] Deletes the currently displayed phone number. Touch to display the confirmation screen. Touch [Yes] to delete or [No] to cancel.

### 4 Search phone number to register with each function

### 5 Register phone number



## SMS (Short Message Service)

Uses SMS function.

### 1 Display the Hands-Free Control screen

See <Making a call> (page 44).

### 2 Display the SMS Select screen



### 3 Select a function



[] Displays the SMS create menu screen.

See <Create a message>.

[] Displays received message list.

[] Displays sent message list.

[] Displays the SMS Create Menu screen.

See <Create a message>. The button will be active when any message has been created after power-on.

[Download] Retrieves SMS messages from the cell-phone.

### 4 Select a message to display



1 Calls the number in the selected message.

[DISP] Displays the selected message.



- If a large number of SMS messages are stored in the cell-phone, message list may not be displayed correctly.

## SMS Message screen



[] [SMS] Creates a new message for the selected message.

## Create a message

### 1 Enter phone number / Select contact



[**Pick**] Select a contact from the phonebook.

[**Direct Number**] Enter the phone number.

[**SET**] Display the Create SMS Message screen.

[**Send**] Sends the message.

[**Delete**] Deletes the Draft message.

Touching the screen displays a confirmation message. Touch [Yes]. To cancel clearing, touch [No].

### 2 Display the Create SMS Message screen



### 3 Create a message

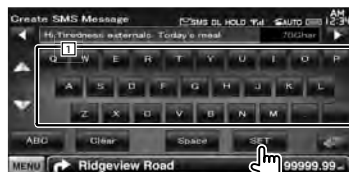

[**1**] Enters characters.

[**◀**], [**▶**] Moves the cursor.

[**▲**], [**▼**] Scrolls up or down the character button display.

[**QWE**]/ [**ABC**] Sets the key layout of the character buttons.

ABC : Alphabetical key layout.

QWE : Qwerty key layout.

[**Clear**] Erases the entered character.

If touched more than 1 second, all the input characters are erased.

[**Space**] Enters a space.

[**SET**] Saves the message and returns to the Create SMS Menu screen.

Only one draft message can be saved / retained in memory at any one time.

### 4 Send the message



# Audio Control

## Audio Control Menu

Displays the Audio Control menu to set the sound effect function of this unit.

### 1 Display the Source Select Screen

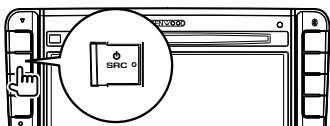

### 2 Display the Audio Control menu



In this manual, the above selection is indicated as:

Touch [Source Select] > [VIDEO].

### 3 Select the Audio Control item



Item	Page
[Audio Control]	54
[Equalizer]	55
└ [Tone]	55
[Zone Control]	56

## Audio Control

You can adjust the front/rear and right/left audio balance.

### 1 Display the Audio Control screen

Touch [Source Select] > [VIDEO] > [Audio Control]. (page 54)

### 2 Set each item



1 Adjusts the front/back and left/right balance of the volume by touching the Adjust screen.

[◀], [▶] Adjusts the right and left volume balance.

[▲], [▼] Adjusts the front and rear volume balance.

**[VOL.Offset]** Finely adjust the volume of the current source to minimize the difference in volume between different sources.



- If you have increased the volume first, then reduced the volume using the "VOL. Offset", the sound generated if you suddenly switch to another source may be extremely loud.

**[Subwoofer Level]** Adjusts the subwoofer volume.

The setting is available when subwoofer is set to "ON". See <Speaker Setup> (page 71).

**[Loudness]** Turns the loudness control function On or Off.

If turned "ON", high and low tones are automatically enhanced during low volume. Settable only when zone function is set to Off. See <Zone Control> (page 56).

**[Stream Information]** Displays the present source information.

The stream (Dolby Digital, dts, Linear PCM, MPEG, MP3, WMA or AAC) is displayed.

## Equalizer Control

You can set up the equalizer.

### 1 Display the Equalizer screen

Touch [◀] > [🔊] > [Equalizer]. (page 54)

### 2 Set each item



**[SystemQ]** Selects an equalizer curve type. You can select any of the following equalizer curves.

"Natural"/ "Rock"/ "Pop"/ "Easy"/ "Top40"/ "Jazz"/ "User"



- "User": Your own tone curve can be created. See <Tone Setup> (page 55).

**[SystemQ-EX]** Selects items to be adjusted for tone curve setup.

If selected "OFF", only Level can be set up for tone curves.

**[Tone]** Displays the Tone curve setup screen. (page 55)

## Tone Setup

You can set a Tone curve.

### 1 Display the Equalizer screen

Touch [◀] > [🔊] > [Equalizer]. (page 54)

### 2 Display the Tone Control screen



### 3 Set the Tone



**[Bass]** Bass adjustment items are displayed.

**[Middle]** Middle adjustment items are displayed.

**[Treble]** Treble adjustment items are displayed.

**[Flat]** Tone level becomes 0 (flat).

**[FREQ]** Sets the Center frequency.

**[Level]** Sets the level.

**[Q Factor]** Sets the Q factor. (Only [Bass] and [Middle] can be set)

**[Bass DC EXT]** Bass DC Extend settings. (Only [Bass] can be set)  
If turned "ON", it extends the bass center frequency to the low register by approximately 20%.

**[SW Level]** Adjusts the subwoofer volume. The setting is available when subwoofer is set to "ON". See <Speaker Setup> (page 71).

## Zone Control

You can set the front and rear audio source.

### 1 Display the Zone Control screen

Touch [  ] > [  ] > [Zone Control]. (page 54)

### 2 Set the Zone Control



**[Single Zone]** Sets the unit to single zone.

**[Dual Zone]** Sets the unit to dual zone.

**[Front Source]** Sets the front audio source.

**[Rear Source]** Sets the rear audio source.



- When the rear speaker sound is switched, the audio source that is output at the AV OUTPUT terminal is also switched to the same source.

**[Rear VOL.]** Adjusts the volume of the rear channel.



- There are following limitations when zone function is set to "ON".
  - There is no output from the subwoofer.
  - <Equalizer Control> (page 55) and <Speaker Setup> (page 71) are not available.



# Setup Menu

You can set up various receiver parameters.

## How to Display SETUP Menu Screen

Displays the Setup menu to set various functions.

### 1 Display the Source Select Screen

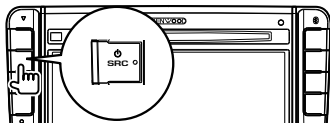

### 2 Display the Setup Menu Screen



In this manual, the above selection is indicated as:

Touch [◀] > [▶].

### 3 Select the setup item



[▲], [▼] Scrolls the setup menu.



- [AV-IN SETUP], [Navigation] and [Audio SETUP] options can be locked. The key mark (🔒) is displayed in reverse video for the locked option. See <Setup Memory> (page 63).

Item	Page
[Information]	
└ [DivX(R)]	58
└ [Software]	58
[System]	
└ [User Interface]	59
└ [Touch]	61
└ [Clock]	61
└ [Security]	62
└ [SETUP Memory]	63
[Display]	
└ [Background]	64
└ [Color]	65
└ [Screen Adjust]	66
[Bluetooth SETUP]	66
[TUNER SETUP]	76
[DVD SETUP]	72
[iPod SETUP]	75
[USB SETUP]	75
[TV SETUP]	76
[AV-IN SETUP]	69
[Navigation]	70
[Audio SETUP]	
└ [Speaker Select]	71
[AV Interface]	70

## DivX Setup

Checks the registration code. This code is needed when making a disc which has DRM (Digital Rights Management).

### 1 Display the DivX Setup screen

Touch [Left Arrow] > [Right Arrow] > [Information] > [DivX].  
(page 57)

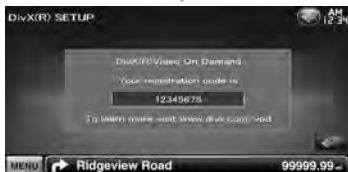

Displays the registration code.



- When downloading a DivX VOD file controlled by DRM, register the code appeared on the screen such as the one above. Otherwise the file may not be able to play with this unit. Remaining number of viewing is displayed when playing a DivX VOD file with the viewing restriction. When the remaining number of viewing reached 0, a warning message appears and the file cannot be played.

## Software Information

Checks the software version of this unit.

### 1 Display the Software Information screen

Touch [Left Arrow] > [Right Arrow] > [Information] > [Software]. (page 57)

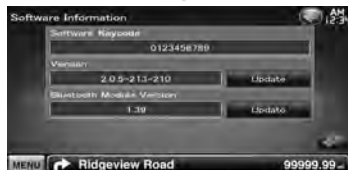

Displays the software version.



- For how to update the software, refer to the relevant update procedure manual which comes with the software.

## User Interface

You can setup user interface parameters.

### 1 Display the User Interface screen

Touch [←] > [→] > [System] > [User Interface]. (page 57)

### 2 Set each item



**[Beep]** Turns the key touch tone On or Off. (☑ "ON")

**[Remote Sensor]** Selects a remote control signal. (☑ "ON")  
When turned "OFF", the remote control of TV reception is rejected.

**[Language]** Select the language used for the control screen and setting items. (page 60)

**[Scroll]** Allows scrolling of text display on the Source Control screen. (☑ "Manual")  
"Auto": Scrolls the screen automatically.  
"Manual": Allows you to scroll the screen manually.

**[Marker]** Sets whether to display the target when touching the panel. (☑ "OFF")

**[Drawer Close]** Sets whether to close the function bar automatically. (☑ "Manual")

**[FNC Key Longer than 1 Second]** Sets the function of the [FNC] button.  
(☑ "V.OFF")  
"V.OFF": Press the [FNC] button for more than 1 second to turn the display off.  
"R-CAM": Press the [FNC] button for more than 1 second to switch to rear view.

**[Animation]** Sets whether to display animation. (☑ "ON")

**[TV Key Setting]** Assign the source to [TV] button on the front panel. (☑ "TV")  
"TV": The button is assigned as [TV].  
"VIDEO1": The button is assigned as [VIDEO1].

**[USB Key Setting]** Assign the source to [USB] button on the front panel. (☑ "USB")  
"USB": The button is assigned as [USB].  
"iPod": The button is assigned as [iPod].

## Language Setting

You can select the display language for the control screen and audio file tags.

### 1 Display the User Interface screen

Touch [Home] > [System] > [User Interface]. (page 57)

### 2 Display the Language Setting screen



### 3 Select a language



**[Select Mode]** Selects language select mode.

( "Easy")

"Easy" : Language to display text and tag information, and language for GUI can be selected.

Navigation language is set to that selected in [Text Language Select].

"Advanced" : Language to display text and tag information, language for GUI, and language for navigation information can be selected.

**[Text Language Select]** Selects the language to display text information of the selected source and tag information of the audio/video files.

( "British English")

**[GUI Language Select]** Selects the language used for the control screen, setting menu and so forth. ( "Local")

"Local" : Sets the language to that selected in [Text Language Select].

"English" : Sets the language to English.

**[Enter]** Determines the selected language.

**[Cancel]** Cancels the selected language.

### When [Select Mode] is set to "Advanced"



**[Navigation Language Select]** Selects the language used for navigation.

( "British English")

## Touch Panel Adjustment

You can adjust the touch panel operations.

### 1 Display the Touch panel Adjustment screen

Touch [←] > [→] > [System] > [Touch].  
(page 57)

### 2 Adjust the Touch panel



Follow the instruction on the screen and touch the center of ⊕.

**[Cancel]** Cancels the adjustment and returns to the Touch Panel Adjust screen.

**[Reset]** Resets to the initial status.

## Clock Setup

You can adjust the clock time.

### 1 Display the Clock Setup screen

Touch [←] > [→] > [System] > [Clock].  
(page 57)

### 2 Setup the Clock



1 Adjusts hours.

2 Adjusts minutes.

**[Reset]** Sets "00" minute.

Setup examples: 3:00 – 3:29 → 3:00

3:30 – 3:59 → 4:00

**[Synchronize]** Sets the clock time in synchronization with the time data sent from the navigation system or the RDS station.

(☑ "Navigation")

"OFF"/ "RDS"/ "Navigation"

When the synchronized mode is set, the clock cannot be adjusted manually.

### 3 Adjust the clock time



## Security Setup

You can set a security code to protect your receiver system against theft.



- When the Security Code function is activated, the code cannot be changed and the function cannot be released. Note the Security Code can be set as the 4 digit number of your choice.

### 1 Display the Security screen

Touch [Home] > [Left Arrow] > [System] > [Security].  
(page 57)

### 2 Setup the SI (Security Indicator)

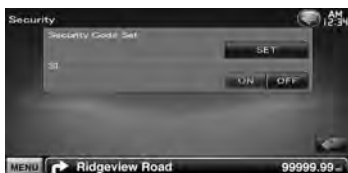

**[Security Code Set]** Displays the Security code input screen.

**[SI]** Turns the SI function on or off.

If turned "ON", the Security indicator on the front panel flashes when the vehicle ignition is off. (☑ "ON")

### 3 Start Security Code setup



- If you have already completed the code registration, [CLR] is displayed.

### 4 Enter a security Code



Input four-digit number.

### 5 Register your security code



### 6 Reenter the security code

Reenter the same security code as that you have entered in Step 4 for confirmation.



- If you enter a different security code, the screen returns to Step 4 (for the first code entry).

### 7 Register the security code again



Now, your security code is registered.

*If you have pressed the Reset button or if you have disconnected the Receiver from battery...*

### 1 Enter the correct security code



You must enter the same security code as that you have entered in Step 4.

### 2 Register your security code



Now, you can use your Receiver.

## Setup Memory

Audio Control, AV-IN SETUP, AV Interface, Navigation, and Audio SETUP settings can be memorized. The memorized settings can be recalled at any time. For example, even when the settings are cleared due to replacement of the battery, the settings can be restored.

### 1 Display the SETUP Memory screen

Touch [←] > [→] > [System] > [SETUP Memory]. (page 57)

### 2 Start Setup Memory



**[Lock]** Locks the AV-IN SETUP, Navigation, and Audio SETUP settings. When [Lock] is selected, you cannot change the AV-IN SETUP, Navigation, and Audio SETUP settings.

**[Yes]** Memorizes or recalls the settings.

**[No]** To cancel the function, touch [No]. To cancel memorization, touch [No]. The SETUP Menu screen appears again.

### 3 Select a desired function



**[Recall]** Recalls the memorized settings.

**[Memory]** Memorizes the current settings.

**[Clear]** Clears the currently memorized settings.

### 4 Memorize or recall the settings

#### When memorizing the Audio Setup and AV Interface settings:



If settings have already been memorized, a confirmation message appears. Touch [Yes]. To cancel memorization, touch [No].

#### When recalling the memorized settings:



Touching the screen displays a confirmation message. Touch [Yes]. To cancel recalling, touch [No].

#### When clearing the currently memorized settings:



Touching the screen displays a confirmation message. Touch [Yes]. To cancel clearing, touch [No].

### 5 Quit memorization/recalling of settings



## Entering Background

Loads a image from the connected USB device and sets it for the background image.

### 1 Connect the device which has the image to load

### 2 Display the Background screen

Touch [◀] > [▶] > [Display] > [Background]. (page 57)

### 3 Display the Background Memory screen



[Change] Selects a image for background.

[Delete] Deletes the background image.  
Touching the screen displays a confirmation message. Touch [Yes]. To cancel clearing, touch [No].

### 4 Select a medium (USB device)



### 5 Select the image to load



1 Lists the files.

[◀] When ◀ appears, the text display is scrolled by touching it.

[↑ ROOT] Moves to the top hierarchy level.

[↑ UP] Moves up a hierarchy level.

### 6 Load the image



1 Rotates the image.



- See <About Picture files> (page 6) for readable image specifications.
- The [Memory] button on the "Background" screen becomes active only in STANDBY source mode.
- Pressing the [Memory] button on the "Background" screen switches the AV OUT source to OFF. For resetting the AV OUT source, refer to <AV Interface Setup> section.
- While loading the Background image, any other operation is prohibited.

### Background Change

Selects a image for background.

#### 1 Select Background Change screen



#### 2 Select a image for background



1 Returns to the initial background.

#### 3 Set the image as the background





## Panel Color Coordinate

Sets the button illumination color.

### 1 Display the Color screen

Touch [Left Arrow] > [Right Arrow] > [Display] > [Color].  
(page 57)

### 2 Display the Panel Color Coordinate screen



**[Initialize]** Initialization resets the settings made using the Panel Color to the default settings made at the factory.

**[Panel Color Scan]** When set to "ON", the illumination color of the buttons changes one after another.



- When touching [SET] or [Initialize], make sure [Panel Color Scan] is set to "OFF".

### 3 Select a color

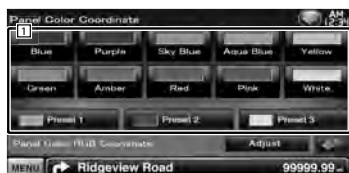

1 Sets to the touched color.

**[Adjust]** Sets and registers favorite color to the preset buttons ([P1] – [P3]).

## To register your original color

### 1 Start the RGB coordinate



### 2 Adjust each color value



1 Selects a preset number to register.

**[Red Value]** Adjusts the Red value.

**[Green Value]** Adjusts the Green value.

**[Blue Value]** Adjusts the Blue value.

### 3 Select a Preset number to register



Adjusted color is registered to the selected Preset button.

### 4 Complete the color coordination



## Screen Adjustment

You can adjust the screen mode of the monitor.

### 1 Display the Screen Adjust screen

Touch [Left Arrow] > [Right Arrow] > [Display] > [Screen Adjust]. (page 57)

### 2 Set each item



**[Bright]** Brightness Control

**[Contrast]** Contrast Control

**[Black]** Black Level Adjustment

**[Dimmer]** Dimmer Mode Setup

"ON": The display dims.

"OFF": The display doesn't dim.

"SYNC": Turning the Dimmer function On or Off when the vehicle light control switch is turned On or Off.

"NAV-SYNC": Turning the Dimmer function On or Off according to the Navigation Day/Night display setting.



- In this Screen Adjust screen, you can perform setups for the menu screen. Setups for videos such as DVD can be performed on the <Screen Control> (page 41).

## Registering Bluetooth Unit

Registers the Bluetooth unit to be connected.

### 1 Display the Bluetooth Setup screen

Touch [Left Arrow] > [Right Arrow] > [Bluetooth SETUP]. (page 57)

### 2 Display the Connect Device List screen



### 3 Search for a Bluetooth unit



- Displays the registered Bluetooth units. The busy service becomes active. The available service becomes inactive.

[Left Arrow] When ◀ appears, the text display is scrolled by touching it.

**[Search]** Searches for a Bluetooth unit.

**[SP DEV]** Registers a Bluetooth unit that cannot be registered by normal register (pairing) operation.



- A new device cannot be registered if there are already 5 Bluetooth units registered. Delete unnecessary registration. See <Bluetooth Unit Connection> (page 68).

#### 4 Select the Bluetooth unit to register



1 Displays the searched Bluetooth unit.

**[Search]** Searches for a Bluetooth unit.

**[Cancel]** Cancels searching of Bluetooth unit.

#### 5 Enter PIN code



1 Enters a code number using the keypad.

**[Enter]** Confirms the entered PIN code. Enter the PIN code specified for the Bluetooth unit you are registering.

This button will not be active until at least four PIN code digits have been entered.

**[Cancel]** Cancels registration of PIN code.

**[Clear]** Clears the code number.



- You can also register from the Bluetooth unit side. For the PIN code necessary for registration, see <Registering Bluetooth Unit PIN Code> (page 68).
- If the error message appears even though the PIN code is correct, try <Registering Special Bluetooth Unit>.

#### Registering Special Bluetooth Unit

Registers Special Bluetooth unit, that resulted in error by normal registration method, by selecting from the listed models.

#### 1 Display the Special Device List screen



#### 2 Select a model name



Displays the Bluetooth unit name that can be registered.

#### 3 Confirm whether to register



- Only models in Bluetooth unit name list can be registered.

#### 4 Go through the procedure of <Registering Bluetooth Unit> and complete the registration (pairing)

## Registering Bluetooth Unit PIN Code

Sets the PIN code of the Bluetooth unit to enter when registering (pairing) from the cell-phone or audio player side.

### 1 Display the Bluetooth Setup screen

Touch [Left Arrow] > [Right Arrow] > [Bluetooth SETUP].  
(page 57)

### 2 Display the Receiver PIN Code screen



### 3 Enter PIN code



1 Enters a code number using the keypad.

**[Cancel]** Cancels registration of PIN code.

**[Enter]** Registers the entered PIN code.

**[Clear]** Clears the code number.

## Bluetooth Unit Connection

Selects the Bluetooth unit to connect.

### 1 Display the Bluetooth Setup screen

Touch [Left Arrow] > [Right Arrow] > [Bluetooth SETUP].  
(page 57)

### 2 Display the Connect Device List screen



### 3 Select a registered Bluetooth unit



### 4 Select the service to use



**[TEL (HFP)]** Connects/disconnects cell-phone to use for Hands Free.

**[Remove]** Deletes registration (pairing).

Touching the screen displays a confirmation message. Touch [Yes]. To cancel clearing, touch [No].

## Bluetooth Hands-Free/Audio Output Setup

Selects speakers to output the sound of hands-free phoning (such as phone call voice and ringing tone).

### 1 Display the Bluetooth Setup screen

Touch [ ] > [ ] > [Bluetooth SETUP].  
(page 57)



**[Bluetooth HF/Audio]** Sets the output speakers. ( ) "Front Only"  
"Front Only": Outputs from the front speakers.  
"All": Outputs from all the speakers.

## AV Input Setup

You can set AV input parameters.

### 1 Display the AV-IN Setup screen

Touch [ ] > [ ] > [AV-IN SETUP]. (page 57)

### 2 Set each item



**[On Screen AV-IN]** Sets an on-screen display of the AV-IN playback screen. ( ) "Auto"

"Auto": Information is displayed for 5 seconds when updated.

"Manual": Information is displayed when you touch on the screen.

**[iPod AV Interface Use]** Sets the terminal to which the iPod is connected to. ( ) "iPod"

**[AV-IN1 Name], [AV-IN2 Name]** Sets a name to be displayed when you select a system that is connected via the AV INPUT port.  
( ) "VIDEO"





- [iPod AV Interface Use]  
This item can be set when in STANDBY source and also the iPod is unconnected.
- [AV-IN Name]  
One AV-IN name is displayed when "iPod" is selected in [iPod AV Interface Use] and two are displayed when not selected.

## AV Interface Setup

You can set audio and visual (AV) interface parameters.

### 1 Display the AV Interface screen

Touch [  ] > [  ] > [AV Interface]. (page 57)

### 2 Set each item



**[AV-OUT]** Selects an AV source to be output at the AV OUTPUT port. (  "AV-IN1")

**[R-CAM Interrupt]** Sets a method to switch to the rear view camera video display.

(  "OFF")

"ON": Switches to the rear camera video display when "Reverse" gear is engaged.

"OFF": The monitor does not switch to the rear view camera video display even when engaging the shift knob of car to "Reverse".



- When in DVD source, "AV-OUT" cannot be set to USB.  
When in USB source, "AV-OUT" cannot be set to DVD.

## Navigation Setup

You can set Navigation parameters.

### 1 Display the Navigation Setup screen

Touch [  ] > [  ] > [Navigation]. (page 57)

### 2 Set each item



**[NAV Interrupt Speaker]** Selects speakers used for voice guidance of the navigation system.

(  "Front All")

"Front L": Uses the front left side speaker for voice guidance.

"Front R": Uses the front right side speaker for voice guidance.

"Front All": Uses both front speakers for voice guidance.

**[NAV Voice Volume]** Adjusts the volume for voice guidance of the navigation system.

(  "25")

**[NAV Mute]** Mutes the volume during voice guidance of the navigation system.

(  "ON")

When turned "ON", the volume level drops for voice guidance.

## Speaker Setup

You can select a speaker type and its size to get the best sound effects.

### 1 Display the Speaker Select screen

Touch [Left Arrow] > [Right Arrow] > [Audio SETUP] > [Speaker Select]. (page 57)

### 2 Select a speaker you wish to adjust

When the speaker type and size are set, the speaker crossover network and equalizer curve are set automatically.



- 1 Front speaker
- 2 Rear speaker
- 3 Subwoofer

**[Subwoofer]** Sets the availability of subwoofers.

**[X'over]** Displays the Speaker Crossover Setup screen.

You can adjust the crossover setup that was set automatically when you selected the speaker type.

### 3 Select a speaker type



You can select front speaker type. "Standard"/ "Wide"/ "Middle"/ "Narrow"



- Speaker cannot be setup when in STANDBY source mode.

## Crossover Network Setup

You can set a crossover frequency of speakers.

### 1 Select the speaker to set the crossover



- 1 Sets the High Pass Filter of the front speaker.
- 2 Sets the High Pass Filter of the rear speaker.
- 3 Sets the Low Pass Filter of the subwoofer.

### 2 Display the Crossover setup screen



### 3 Set the crossover



**[Phase]** Sets the phase of subwoofer output. The phase is reversed 180 degrees when set to "Reverse".

Sets the subwoofer phase. (Only when "Subwoofer" is set to "ON" in Speaker Setup, and [LFP FREQ] is set to other than "Through")

**[HPF FREQ]** High Pass Filter adjustment. (When front or rear speaker is selected on Speaker Select screen)

**[LFP FREQ]** Low Pass Filter adjustment. (Only when "Subwoofer" is set to "ON" in Speaker Setup)

## DVD Setup

You can set up the DVD play.

### 1 Display the DVD Setup screen

Touch [◀] > [▶] > [DVD SETUP]. (page 57)

### 2 Set each item



**[Menu Language]\*** Selects a disc menu language.

(See <DVD Language Setup>, page 73)

**[Subtitle Language]\*** Selects a subtitle language.

(See <DVD Language Setup>, page 73)

**[Audio Language]\*** Selects an audio language.

(See <DVD Language Setup>, page 73)

**[Dynamic Range Control]\*** Sets the dynamic range. (Icon: "Dialog")

The dynamic range is reduced by changing from "Wide" to "Normal" and from "Normal" to "Dialog". "Dialog" makes the total sound volume becomes larger as compared with "Wide" and "Normal", allowing you to listen to the movie's dialog more clearly.

This is effective only when you are using a Dolby Digital software.

The operation is available during the play stop mode.

**[Angle Mark]** Sets an angle mark display. (Icon: "ON")

**[Screen Ratio]\*** Selects the screen display mode. (Icon: "16:9")

"16:9": Displays wide pictures.

"4:3 LB": Displays wide pictures in the Letter Box format (having black stripes at the top and bottom of screen).

"4:3 PS": Displays wide pictures in the Pan & Scan format (showing pictures cut at the right and left ends).

**[Parental Level]\*** Displays the Parental Lock screen. (Icon: "OFF")

(See <DVD Parental Level Setup>, page 73)

**[Disc SETUP]** Makes the settings related to the disc media. (See <Disc Setup>, page 74)



- \* Disabled when a DVD is being played.



## DVD Language Setup

Selects a language you use for the speech and menus.

### 1 Display the DVD Setup screen

Touch [◀] > [▶] > [DVD SETUP]. (page 57)

### 2 Select the language item to set



### 3 Enter a language code

See <DVD Language Codes> (page 79) and select the desired language.

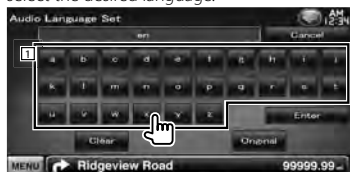

1 Enters a language code.

**[Cancel]** Cancels the language setup and returns to the "DVD SETUP" screen.

**[Enter]** Sets the language and returns to the "DVD SETUP" screen. (It appears after you have entered a language code.)

**[Original]** Sets the DVD's original language (only when setting an audio language).

**[Clear]** Clears the language code.

### 4 Set the language you use



## DVD Parental Level Setup

Sets a parental level.

### 1 Display the DVD Setup screen

Touch [◀] > [▶] > [DVD SETUP]. (page 57)

### 2 Display the Parental Level code number screen



### 3 Enter the code number



1 Enters a code number.

**[Cancel]** Cancels the current setup and returns to the "DVD SETUP" screen.

**[Level]** Indicates the present parental lock level.

**[Enter]** Determines the code number and displays the Parental Level setup screen.

**[Clear]** Clears the code number.



- The number you enter first is set as your code number.

### 4 Display the Parental Level SETUP screen



Next page ▶

## 5 Select a parental level and complete the setup

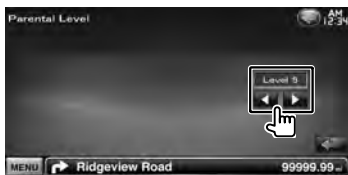

Selects a parental level.



- If a disc has higher parental lock level, you need to enter the code number.
- The parental lock level varies depending on a loaded disc.
- If a disc has no parental lock, anybody can play it back even when you have set the parental lock.

## Disc Setup

Performs setup when using disc media.

### 1 Display the DVD Setup screen

Touch [ ] > [ ] > [DVD SETUP]. (page 57)

### 2 Display the Disc Setup screen



### 3 Set each item



**[Picture Display Time]** Selects a picture display time. ( ) "Long"  
The Display of a JPEG picture is changed. ("Short", "Middle", "Long")

**[CD Read]** Sets a music CD playback. ( ) "1"  
"1": Automatically recognizes and plays back an Audio file disc, a DVD or a music CD.  
"2": Forcibly plays back a disc as a music CD. Select "2" if you wish to play a music CD having a special format or if you cannot play a disc in the "1" position.

**[On Screen DVD]** Sets an on-screen display of the DVD Playback screen. ( ) "Manual"  
"Auto": Information is displayed for 5 seconds when updated.  
"Manual": Information is displayed when you touch on the screen.



- [CD Read]  
Disabled when a disc is in the unit.  
You cannot play an Audio file/VCD disc in the "2" position. Also, you may not play some music CDs in the "2" position.

## USB Setup

Performs setup when using USB.

### 1 Display the USB Setup screen

Touch [⏪] > [⏩] > [USB SETUP]. (page 57)

### 2 Set each item



**[Picture Display Time]** Selects a picture display time. (📄 "Long")

The Display of a JPEG picture is changed. ("Short", "Middle", "Long")

**[On Screen USB]** Sets an on-screen display of the USB Playback screen. (📄 "Auto")

"Auto": Information is displayed for 5 seconds when updated.

"Manual": Information is displayed when you touch on the screen.

## iPod Setup

Performs setup when using iPod.

### 1 Display the iPod Setup screen

Touch [⏪] > [⏩] > [iPod SETUP]. (page 57)

### 2 Set each item



**[AudioBook Speed]** Sets the Audio book playback speed. (📄 "Normal")

**[Wide Screen]** Sets Wide Screen on or off. (📄 "OFF")

**[On Screen iPod]** Sets an on-screen display of the iPod Playback screen. (📄 "Auto")

"Auto": Information is displayed for 5 seconds when updated.

"Manual": Information is displayed when you touch on the screen.



- "Wide Screen" cannot be set while the iPod is connected.

## Tuner Setup

You can set Tuner related parameters.

### 1 Display the Tuner Setup screen

Touch [Home] > [Left Arrow] > [TUNER SETUP]. (page 57)

### 2 Set each item



**[NEWS]** Sets a news bulletin interrupt time. (Icon "OFF")

**[AF]** When station reception is poor, automatically switches to the station that is broadcasting the same program over the same RDS network. (Icon "ON")

**[Regional]** Sets whether to switch to the station only in the specific region using the "AF" control. (Icon "ON")

**[Auto TP Seek]** When traffic information station reception is poor, automatically searches for a station that can be received better. (Icon "ON")

**[Language Select]** Selects a display language for the PTY function.

## TV Setup

The TV signal receiving areas can be set.

### 1 Display the TV SETUP screen

Touch [Home] > [Left Arrow] > [TV SETUP]. (page 57)

### 2 Set each item



**[TV1 Area], [TV2 Area]** Sets the TV receiving area. (only when KTC-V300E/KTC-V301E (optional accessory) connected)

**[On Screen TV]** Sets an on-screen display of the TV screen. (Icon "Auto") (only when the optional accessory TV tuner connected)

"Auto": Information is displayed for 5 seconds when updated.

"Manual": Information is displayed when you touch on the screen.

### 3 Set up TV (only when KTC-V300E/KTC-V301E (optional accessory) connected)

Example : TV1 Area screen



Sets the present TV1 or TV2 receiving area.

# Initial Setup

When pressing the Reset button or turning on the unit for the first time, the Initial SETUP screen is displayed.

## Initial Setup

### 1 Turn the power On

### 2 Set each item

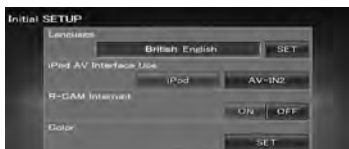

**[Language]** Select the language used for the control screen and setting items. (page 60)

**[iPod AV Interface Use]** Sets the terminal to which the iPod is connected to. (📁 "iPod")

**[R-CAM Interrupt]** Sets a method to switch to the rear view camera video display.

📁 "OFF")

"ON": Switches to the rear camera video display when "Reverse" gear is engaged.

"OFF": The monitor does not switch to the rear view camera video display even when engaging the shift knob of car to "Reverse".

**[Color]** Sets the screen and button illumination color. (page 65)

### 3 End initial setup



- The settings above can be changed in <Setup Menu> (page 57).

# Status bar Indicator items

Shown below is a list of indicators displayed on the Status bar.



Source	Display	Overview
General	"AT"	Indicates that the attenuator is active.
	"DUAL"	Turns on the Dual zone function.
	"TEL"	Indicates the connection state of the Bluetooth hands-free unit. (Orange: Connected. White: Not connected.)
DVD/CD MEDIA	"FO-REP"	Indicates that the Folder repeat function is ON.
	"IN"	Indicates that a disc is inserted. (White: A Disc is inside the unit. Orange: Error at the disc player.)
	"MOVIE"	Identifies the video file.
	"MUSIC"	Identifies the music file.
	"PICTURE"	Identifies the image file.
	"RDM"	Indicates that the Random function is ON.
	"REP"	Indicates that the Repeat function is ON.
DVD-Video	"SLIDE"	Indicates that the slide show function is ON.
	"C-REP"	Indicates that the Chapter repeat function is ON.
DVD-VR	"T-REP"	Indicates that the Title repeat function is ON.
	"1 M/S"	Identifies the primary/secondary audio output of stream 1.
	"1 MAIN"	Identifies the primary audio output of stream 1.
	"1 SUB"	Identifies the secondary audio output of stream 1.
	"PLST"	Identifies the Play list mode.
VCD	"T-REP"	Indicates that the Title repeat function is ON.
	"1chLL"	Identifies the left audio output of channel 1.
	"1chLR"	Identifies the monaural audio output of channel 1.
	"1chRR"	Identifies the right audio output of channel 1.
	"1chSL"	Identifies the stereo audio output of channel 1.
	"LL"	Identifies the left audio output.
	"LR"	Identifies the monaural audio output.
	"RR"	Identifies the right audio output.
	"ST"	Identifies the stereo audio output.
	"PBC"	Indicates that the PBC function is ON.
	"SVCDC"	Identifies the Super Video CD.
	"VER1"	Indicates that the Video CD version is 1.
	"VER2"	Indicates that the Video CD version is 2.
	"REP"	Indicates that the Repeat function is ON.

Source	Display	Overview
USB	"FO-REP"	Indicates that the Folder repeat function is ON.
	"MOVIE"	Identifies the video file.
	"MUSIC"	Identifies the music file.
	"PICTURE"	Identifies the image file.
	"RDM"	Indicates that the Random function is ON.
	"REP"	Indicates that the Repeat function is ON.
	"PLST"	Indicates that the Play list mode is selected now.
iPod	"SLIDE"	Indicates that the slide show function is ON.
	"MUSIC"	Identifies the music file.
	"VIDEO"	Identifies the video file.
Tuner	"RDM"	Indicates that the Random function is ON.
	"A-RDM"	Indicates that the Album random function is ON.
	"REP"	Indicates that the Repeat function is ON.
TV	"AF"	Indicates that the AF search function is ON.
	"AUTO1"	Indicates that Seek mode is set to Auto1.
	"AUTO2"	Indicates that Seek mode is set to Auto2.
	"EON"	Indicates that the RDS station is sending EON.
	"LOS"	Indicates that the Local seek function is ON.
	"MANU"	Indicates that Seek mode is set to Manual.
	"MONO"	Indicates that the forced monaural function is ON.
	"NEWS"	Indicates that news bulletin interruption is in progress.
	"RDS"	Indicates the state of the RDS station when the AF function is ON. (Orange: RDS is being received. White: RDS is not being received.)
	"ST"	Indicates that stereo broadcast is being received.
TV	"TI"	Indicates the reception state of traffic information. (Orange: TP is being received. White: TP is not being received.)
	"AUTO1"	Indicates that Seek mode is set to Auto1.
TV	"AUTO2"	Indicates that Seek mode is set to Auto2.
	"MANU"	Indicates that Seek mode is set to Manual.

# DVD Language Codes

Code	Language
aa	Afar
ab	Abkhazian
af	Afrikaans
am	Amharic
ar	Arabic
as	Assamese
ay	Aymara
az	Azerbaijani
ba	Bashkir
be	Byelorussian
bg	Bulgarian
bh	Bihari
bi	Bislama
bn	Bengali, Bangla
bo	Tibetan
br	Breton
ca	Catalan
co	Corsican
cs	Czech
cy	Welsh
da	Danish
de	German
dz	Bhutani
el	Greek
en	English
eo	Esperanto
es	Spanish
et	Estonian
eu	Basque
fa	Persian
fi	Finnish
fj	Fiji
fo	Faroese
fr	French
fy	Frisian
ga	Irish
gd	Scots Gaelic
gli	Galician
gn	Guarani
gu	Gujarati
ha	Hausa
he	Hebrew
hi	Hindi
hr	Croatian
hu	Hungarian
hy	Armenian
ia	Interlingua
ie	Interlingue
ik	Inupiak
id	Indonesian

Code	Language
is	Icelandic
it	Italian
ja	Japanese
jv	Javanese
ka	Georgian
kk	Kazakh
kl	Greenlandic
km	Cambodian
kn	Kannada
ko	Korean
ks	Kashmiri
ku	Kurdish
ky	Kirghiz
la	Latin
lb	Luxembourgish
ln	Lingala
lo	Laotian
lt	Lithuanian
lv	Latvian, Lettish
mg	Malagasy
mi	Maori
mk	Macedonian
ml	Malayalam
mn	Mongolian
mo	Moldavian
mr	Marathi
ms	Malay
mt	Maltese
my	Burmese
na	Nauru
ne	Nepali
nl	Dutch
no	Norwegian
oc	Occitan
om	(Afan) Oromo
or	Oriya
pa	Punjabi
pl	Polish
ps	Pashto, Pushto
pt	Portuguese
qu	Quechua
rm	Rhaeto-Romance
r	Kirundi
ro	Romanian
ru	Russian
rw	Kinyarwanda
sa	Sanskrit
sd	Sindhi
sg	Sangho
sh	Serbo-Croatian

Code	Language
si	Singhalese
sk	Slovak
sl	Slovenian
sm	Samoaan
sn	Shona
so	Somali
sq	Albanian
sr	Serbian
ss	Siswati
st	Sesotho
su	Sundanese
sv	Swedish
sw	Swahili
ta	Tamil
te	Telugu
tg	Tajik
th	Thai
ti	Tigrinya
tk	Turkmen
tl	Tagalog
tn	Setswana
to	Tongan
tr	Turkish
ts	Tsonga
tt	Tatar
tw	Twi
uk	Ukrainian
ur	Urdu
uz	Uzbek
vi	Vietnamese
vo	Volapuk
wo	Wolof
xh	Xhosa
yo	Yoruba
zh	Chinese
zu	Zulu

Some functions of this unit may be disabled by some settings made on this unit.

- !** • **Cannot set up the subwoofer.**
- **Cannot set up subwoofer phase.**
- **No output from the subwoofer.**
- **Cannot set up the low pass filter.**
- **Cannot set up the high pass filter.**
  - ▶ Subwoofer is not set to On.
    - ☞ <Speaker Setup> (page 71)
  - ▶ The Dual zone function is enabled.
    - ☞ <Zone Control> (page 56)
  - ▶ The unit is set to STANDBY source.

- !** • **Cannot select the output destination of the subsource in the Dual zone.**
- **Cannot adjust the volume of the rear speakers.**
  - ▶ The Dual zone function is disabled.
    - ☞ <Zone Control> (page 56)

- !** **Cannot play audio files.**
  - ▶ "CD Read" of <Disc Setup> (page 74) is set to "2".

- !** **Cannot Folder select.**
  - ▶ The Random play function is enabled.

- !** **Cannot perform Repeat play.**
  - ▶ The PBC function is enabled.

- !** • **Cannot set up the equalizer.**
- **Cannot set up the crossover network.**
  - ▶ The Dual zone function is enabled.
    - ☞ <Zone Control> (page 56)
  - ▶ The unit is set to STANDBY source.

What might seem to be a malfunction in your unit may just be the result of slight misoperation or miswiring. Before calling service, first check the following table for possible problems.

## General

- ? The Touch Sensor Tone doesn't sound.**
  - ✓ The preout jack is being used.
  - ☞ The Touch Sensor Tone can't be output from the preout jack.

## Tuner source

- ? Radio reception is poor.**
  - ✓ The car antenna is not extended.
    - ☞ Pull the antenna out all the way.
  - ✓ The antenna control wire is not connected.
  - ☞ Connect the wire correctly, referring to the section on <INSTALLATION MANUAL>.

## Disc source

- ? The specified disc does not play, but another one plays instead.**
  - ✓ The specified CD is quite dirty.
    - ☞ Clean the CD.
  - ✓ The disc is severely scratched.
  - ☞ Try another disc instead.

## Audio file source

- ? The sound skips when an Audio file is being played.**
  - ✓ The media is scratched or dirty.
    - ☞ Clean the media, referring to the CD cleaning of the section on <Handling discs> (page 4).
  - ✓ The recording condition is bad.
  - ☞ Record the media again or use another media.

## Hands-Free operation

- ? SMS messages are not displayed correctly.**
  - ☞ Turn off the unit and turn it back on.



When the unit fails to operate correctly, the cause of the failure appears on the display.

---

**"Protect" :**

Protection circuit has been activated because a speaker cord has shorted or it has come in contact with the car chassis.

- ➡ Wire or insulate the speaker cord as appropriate and then push the Reset button.

---

**"Hot Error" :**

When the internal temperature of this unit rises to 60°C or more, the protection circuit is activated and you may not be able to operate the unit. At such times this message will appear.

- ➡ Use the unit again after reducing the temperature inside the vehicle.

---

**"Mecha Error" :**

The disc player is malfunctioning.

- ➡ Eject the disc and try inserting it again. Contact the Kenwood dealer if this indicator continues blinking or the disc cannot be ejected.

---

**"Disc Error" :**

Disc is quite dirty.

- ➡ Clean the disc, referring to the section on <Handling discs> (page 4).
- Disc is upside down.
- ➡ Load the disc with the labeled side up.
- An unplayable disc is inserted.

---

**"Region Code Error" :**

The disc you wanted to play has a region code that cannot be played with this unit.

---

**"Parental Level Error" :**

The disc you wanted to play has a higher level than the parental level you set.

---

**"No Device" (USB device):**

The USB device is selected as a source although no USB device is connected.

- ➡ Change the source to any source other than USB. Connect an USB device, and change the source to USB again.

---

**"Disconnected" (iPod):**

The iPod is selected as a source although no iPod is connected.

- ➡ Change the source to any source other than iPod. Connect an iPod, and change the source to iPod again.

---

**"No Media File" :**

The connected USB device contains no playable audio file.

Media was played that doesn't have data recorded that the unit can play.

---

**"USB Device Error!!" :**

The connected USB device is rated a current capacity higher than the allowable limit.

- ➡ Check the USB device. Some trouble may have occurred to the connected USB device.
- ➡ Change the source to any source other than USB. Remove the USB device.

---

**"Authorization Error" :**

Connection to the iPod has failed.

- ➡ Remove the iPod and then reconnect it. The unit does not support the iPod.
- ➡ Refer to <iPod/iPhone that can be connected to this unit> (page 6).

---

**"Update your iPod" :**

The iPod's software is an older version which the unit can not support.

- ➡ Confirm that the software for the iPod is the latest version. Refer to <iPod/iPhone that can be connected to this unit> (page 6).

---

**"You only can connect one iPod.":**

More than one iPod are connected to this unit.

- ➡ Connect only one iPod to the USB terminal with iPod tag.

---

**"Navigation Error. Please turn on power again later.":**

The communication error has occurred due to severely cold temperature.

- ➡ Turn on power again after warming your car interior.

# Specifications

## Monitor section

### Picture Size

- : 7 inches (diagonal) wide
- : 156.6 mm (W) x 81.6 mm (H)

### Display System

- : Transparent TN LCD panel

### Drive System

- : TFT active matrix system

### Number of Pixels

- : 1,152,000 (800H x 480V x RGB)

### Effective Pixels

- : 99.99 %

### Pixel Arrangement

- : RGB striped arrangement

### Back Lighting

- : LED

## DVD player section

### D/A Converter

- : 24 bit

### Audio Decoder

- : Linear PCM/ Dolby Digital/ dts/ MP3/ WMA/ AAC/ WAV

### Video Decoder

- : MPEG1/ MPEG2/ DivX

### Wow & Flutter

- : Below Measurable Limit

### Frequency Response

- Sampling frequency 96 kHz : 20 – 22,000 Hz
- Sampling frequency 48 kHz : 20 – 22,000 Hz
- Sampling frequency 44.1 kHz : 20 – 20,000 Hz

### Total Harmonic Distortion

- : 0.010 % (1 kHz)

### S/N Ratio (dB)

- : 98 dB (DVD-Video 96 kHz)

### Dynamic Range

- : 98 dB (DVD-Video 96 kHz)

### Disc Format

- : DVD-Video/ VIDEO-CD/ CD-DA

### Sampling Frequency

- : 44.1/ 48/ 96 kHz

### Quantifying Bit Number

- : 16/ 20/ 24 bit

## USB interface section

### USB Standard

- : USB 2.0

### File System

- : FAT 16/ 32

### Maximum Power Supply Current

- : 500 mA

### D/A Converter

- : 24 Bit

### Video Decoder

- : MPEG1/ MPEG2/ DivX

### Audio Decoder

- : MP3/ WMA/ AAC/ WAV

## Bluetooth section

### Technology

- : Bluetooth Ver. 2.0 Certified

### Frequency

- : 2.402 – 2.480 GHz

### Output Power

- : +4dBm (MAX), 0dBm (AVE), Power Class2

### Maximum Communication range

- : Line of sight approx. 10 m (32.8 ft)

### Profile

- HFP (Hands Free Profile)
- SPP (Serial Port Profile)
- HSP (Headset Profile)
- OPP (Object Push Profile)
- PBAP (Phonebook Access Profile)
- SYNC (Synchronization Profile)

### FM tuner section

#### Frequency Range

: 50 kHz : 87.5 MHz – 108.0 MHz

#### Usable Sensitivity (S/N : 26 dB)

: 0.7  $\mu$ V/ 50  $\Omega$

#### Quieting Sensitivity (S/N : 46 dB)

: 1.6  $\mu$ V/ 75  $\Omega$

#### Frequency Response ( $\pm$ 3.0 dB)

: 30 Hz – 15 kHz

#### S/N Ratio (dB)

: 65 dB (MONO)

#### Selectivity ( $\pm$ 400 kHz)

:  $\geq$  80 dB

#### Stereo Separation

: 35 dB (1 kHz)

### LW tuner section

#### Frequency Range (9 kHz)

: 153 kHz – 279 kHz

#### Usable Sensitivity

: 45  $\mu$ V

### MW tuner section

#### Frequency Range (9 kHz)

: 531 kHz – 1611 kHz

#### Usable Sensitivity

: 25  $\mu$ V

### Video section

#### Color System of External Video Input

: NTSC/ PAL

#### External Video Input Level (mini jack)

: 1 V<sub>p-p</sub>/ 75  $\Omega$

#### External Audio Max Input Level (mini jack)

: 2 V/ 25 k $\Omega$

#### Video Output Level (RCA jacks)

: 1 V<sub>p-p</sub>/ 75  $\Omega$

#### Audio Output Level (RCA jacks)

: 1.2 V/ 10 k $\Omega$

### Audio section

#### Maximum Power (Front & Rear)

: 50 W x 4

#### Full Bandwidth Power (Front & Rear)

: 30 W x 4 (PWR DIN 45324, +B=14.4 V)

#### Preout Level (V)

: 2 V/ 10 k $\Omega$

#### Preout Impedance

:  $\leq$  600  $\Omega$

#### Speaker Impedance

: 4 – 8  $\Omega$

#### Tone Action

Bass : 100 Hz  $\pm$  8 dB

Middle : 1 kHz  $\pm$  8 dB

Treble : 10 kHz  $\pm$  8 dB

### Navigation section

#### Receiver

: High-sensitivity GPS receiver

#### Reception Frequency

: 1575.42 MHz (C/A code)

#### Acquisition Times

Cold : < 38 seconds

Factory Reset : < 45 seconds

(On average for a stationary receiver with a clear view of the sky)

#### Accuracy

Position : < 10 meters typical

Velocity : 0.05 m/sec. RMS

#### Position Method

: GPS

#### Antenna

: External GPS antenna

### General

#### Operating voltage

: 14.4 V (10.5 – 16 V allowable)

#### Maximum Current Consumption

: 15 A

#### Installation Dimensions (W × H × D)

: 182 × 100 × 150 mm

7-3/16 x 3-15/16 x 5-7/8 inch

#### Operational Temperature Range

: -10 °C – +60 °C

#### Storage Temperature Range

: -20 °C – +85 °C

#### Weight

: 2.1 kg (4.6 lbs)

Specifications subject to change without notice.

Although the effective pixels for the liquid crystal panel is given as 99.99% or more, 0.01% of pixels may not light or may light incorrectly.

The "AAC" logo is a trademark of Dolby Laboratories.

Font for this product is designed by Ricoh.

iPod is a trademark of Apple Inc., registered in the U.S. and other countries.

iPhone is a trademark of Apple Inc.

iTunes is a trademark of Apple Inc.

"Made for iPod" means that an electronic accessory has been designed to connect specifically to iPod and has been certified by the developer to meet Apple performance standards.

"Works with iPhone" means that an electronic accessory has been designed to connect specifically to iPhone and has been certified by the developer to meet Apple performance standards.

Apple is not responsible for the operation of this device or its compliance with safety and regulatory standards.

 is a trademark of DVD Format/Logo Licensing Corporation registered in the U.S., Japan and other countries.

This product incorporates copyright protection technology that is protected by U.S. patents and other intellectual property rights. Use of this copyright protection technology must be authorized by Macrovision, and is intended for home and other limited viewing uses only unless otherwise authorized by Macrovision. Reverse engineering or disassembly is prohibited.

Manufactured under license from Dolby Laboratories.

Dolby and the double-D symbol are trademarks of Dolby Laboratories.

Manufactured under license under U.S. Patent #'s: 5,451,942; 5,956,674; 5,974,380; 5,978,762; 6,487,535 & other U.S. and worldwide patents issued & pending. DTS is a registered trademark and the DTS logos, Symbol and DTS 2.0 Channel are trademarks of DTS, Inc. © 1996-2008 DTS, Inc. All Rights Reserved.

#### **ABOUT DIVX VIDEO:**

DivX® is a digital video format created by DivX, Inc. This is an official DivX Certified device that plays DivX video. Visit [www.divx.com](http://www.divx.com) for more information and software tools to convert your files into DivX video.

#### **ABOUT DIVX VIDEO-ON-DEMAND:**

This DivX Certified® device must be registered in order to play DivX Video-on-Demand (VOD) content. To generate the registration code, locate the DivX VOD section in <DivX Setup> (page 58). Go to [vod.divx.com](http://vod.divx.com) with this code to complete the registration process and learn more about DivX VOD.

DivX® is a registered trademark of DivX, Inc., and is under license.

The Bluetooth word mark and logos are owned by the Bluetooth SIG, Inc. and any use of such marks by Kenwood Corporation is under license. Other trademarks and trade names are those of their respective owners.

### **The marking of products using lasers**

**CLASS 1  
LASER PRODUCT**

The label is attached to the chassis/case and says that the component uses laser beams that have been classified as Class 1. It means that the unit is utilizing laser beams that are of a weaker class. There is no danger of hazardous radiation outside the unit.



• Declaration of Conformity with regard to the EMC Directive 2004/108/EC  
• Declaration of Conformity with regard to the R&TTE Directive 1999/5/EC  
**Manufacturer:**

Kenwood Corporation  
2967-3 Ishikawa-machi, Hachioji-shi, Tokyo, 192-8525 Japan

**EU Representative's:**

Kenwood Electronics Europe BV  
Amsterdamseweg 37, 1422 AC UITHOORN, The Netherlands

## English

Hereby, Kenwood declares that this unit DNXS20VBT is in compliance with the essential requirements and other relevant provisions of Directive 1999/5/EC.

## Français

Par la présente Kenwood déclare que l'appareil DNXS20VBT est conforme aux exigences essentielles et aux autres dispositions pertinentes de la directive 1999/5/CE.

Par la présente, Kenwood déclare que ce DNXS20VBT est conforme aux exigences essentielles et aux autres dispositions de la directive 1999/5/CE qui lui sont applicables.

## Deutsch

Hiermit erklärt Kenwood, dass sich dieser DNXS20VBT in Übereinstimmung mit den grundlegenden Anforderungen und den anderen relevanten Vorschriften der Richtlinie 1999/5/EG befindet. (BMW)

Hiermit erklärt Kenwood die Übereinstimmung des Gerätes DNXS20VBT mit den grundlegenden Anforderungen und den anderen relevanten Festlegungen der Richtlinie 1999/5/EG. (Wien)

## Nederlands

Hierbij verklaart Kenwood dat het toestel DNXS20VBT in overeenstemming is met de essentiële eisen en de andere relevante bepalingen van richtlijn 1999/5/EG.

Bij deze verklaart Kenwood dat deze DNXS20VBT voldoet aan de essentiële eisen en aan de overige relevante bepalingen van Richtlijn 1999/5/EC.

## Italiano

Con la presente Kenwood dichiara che questo DNXS20VBT è conforme ai requisiti essenziali ed alle altre disposizioni pertinenti stabilite dalla direttiva 1999/5/CE.

## Español

Por medio de la presente Kenwood declara que el DNXS20VBT cumple con los requisitos esenciales y cualesquiera otras disposiciones aplicables o exigibles de la Directiva 1999/5/CE.

## Português

Kenwood declara que este DNXS20VBT está conforme com os requisitos essenciais e outras disposições da Directiva 1999/5/CE.

## Polska

Kenwood niniejszym oświadcza, że DNXS20VBT spełnia zasadnicze wymagania oraz inne istotne postanowienia dyrektywy 1999/5/EC.

## Český

Kenwood tímto prohlašuje, že DNXS20VBT je ve shodě se základními požadavky a s dalšími příslušnými ustanoveními Nařízení vlády č. 426/2000 Sb.

## Magyar

Alulírott, Kenwood, kijelenti, hogy a jelen DNXS20VBT megfelel az 1999/5/EC irányelvben meghatározott alapvető követelményeknek és egyéb vonatkozó előírásoknak.

## Svenska

Härmed intygar Kenwood att denna DNXS20VBT står i överensstämmelse med de väsentliga egenskapskrav och övriga relevanta bestämmelser som framgår av direktiv 1999/5/EG.

## Suomi

Kenwood vakuuttaa täten että DNXS20VBT tyypinen laite on direktiivin 1999/5/EY oleellisten vaatimusten ja sitä koskevien direktiivin muiden ehtojen mukainen.

## Slovensko

S tem Kenwood izjavlja, da je ta DNXS20VBT v skladu z osnovnimi zahtevami in ostalimi ustreznimi predpisi Direktive 1999/5/EC.

## Slovensky

Spoločnosť Kenwood týmto vyhlasuje, že DNXS20VBT spĺňa základné požiadavky a ďalšie príslušné ustanovenia Direktívy 1999/5/EC.

## Dansk

Undertegnede Kenwood erklærer herved, at følgende udstyr DNXS20VBT overholder de væsentlige krav og øvrige relevante krav i direktiv 1999/5/EF.

## Ελληνικά

ΜΕ ΤΗΝ ΠΑΡΟΥΣΑ Kenwood ΔΗΛΩΝΕΙ ΟΤΙ ΔNXS20VBT ΣΥΜΜΟΡΦΩΝΕΤΑΙ ΠΡΟΣ ΤΙΣ ΟΥΣΙΩΔΕΙΣ ΑΠΑΙΤΗΣΕΙΣ ΚΑΙ ΤΙΣ ΛΟΙΠΕΣ ΣΧΕΤΙΚΕΣ ΔΙΑΤΑΞΕΙΣ ΤΗΣ ΟΔΗΓΙΑΣ 1999/5/ΕΚ.

## Eesti

Sellega kinnitab Kenwood, et see DNXS20VBT vastab direktiivi 1999/5/EC põhilistele nõudmistele ja muudele asjakohastele määrustele.

## Latviešu

Ar šo, Kenwood, apstiprina, ka DNXS20VBT atbilst Direktīvas 1999/5/EK galvenajām prasībām un citiem tās nosacījumiem.

## Lietuviškai

Šiuo, Kenwood, pareiškia, kad šis DNXS20VBT atitinka pagrindinius Direktyvos 1999/5/EB reikalavimus ir kitas svarbias nuostatas.

## Malti

Hawnhekk, Kenwood, jiddikjara li dan DNXS20VBT jikkonforma mal-htigijiet essenzjali u ma provvedimenti oħrajn rilevanti li hemm fid-Direttiva 1999/5/EC.

## Українська

Компанія Kenwood заявляє, що цей виріб DNXS20VBT відповідає ключовим вимогам та іншим пов'язаним положенням Директиви 1999/5/EC.

**Information on Disposal of Old Electrical and Electronic Equipment and Batteries  
(applicable for EU countries that have adopted separate waste collection systems)**



**Pb**

Products and batteries with the symbol (crossed-out wheeled bin) cannot be disposed as household waste.

Old electrical and electronic equipment and batteries should be recycled at a facility capable of handling these items and their waste byproducts.

Contact your local authority for details in locating a recycle facility nearest to you. Proper recycling and waste disposal will help conserve resources whilst preventing detrimental effects on our health and the environment.

Notice: The sign "Pb" below the symbol for batteries indicates that this battery contains lead.

This Product is not installed by the manufacturer of a vehicle on the production line, nor by the professional importer of a vehicle into an EU Member State.

---

**KENWOOD**