

KENWOOD

DUAL DIN SIZED CD RECEIVER

DPX503U

DPX303

DPX313

INSTRUCTION MANUAL

Kenwood Corporation



**Declaration of Conformity with regard to the EMC Directive
2004/108/EC**

Manufacturer:

Kenwood Corporation

2967-3 Ishikawa-machi, Hachioji-shi, Tokyo, 192-8525 Japan

EU Representative's:

Kenwood Electronics Europe BV

Amsterdamseweg 37, 1422 AC UITHOORN, The Netherlands



Contents

Before use	3	Audio Adjustments	19
Basic Operation	4	Cabin selection	
General functions		DTA (Digital Time Alignment) setting	
Tuner functions		X'Over setting	
Disc & Audio file play functions		Equalizer Control	
Function Control	6	Preset position selection	
Display Settings	9	Manual position setting	
About Display Type		Audio Preset Memory	
Text Display Selection		Audio Preset Recall	
Illumination Color Selection		Audio Control	
Illumination Color Preset Memory		Audio Setup	
Illumination Color Preset Recall		Speaker Setting	
Disc Naming (DNPS)		Audio Preset Memory	
Auxiliary Input Display Setting		Audio Preset Recall	
Opening message edit		Basic Operations of remote control	25
Music disc/Audio file Operation	13	Appendix	26
Music Select		Accessories/ Installation Procedure	30
Direct Music Search		Connecting Wires to Terminals	31
Direct Disc Search		Installation/Removing the Unit	33
Basic Operation of Disc Changer (Optional)		Troubleshooting Guide	34
Tuner Operation	15	Specifications	36
Station Preset Memory			
Preset Tuning			
Direct Access Tuning			
Changing Language for PTY Function			
PTY (Program Type)			
Program Type preset			
Other Functions	17		
Activating Security Code			
Deactivating Security Code			
Manual Clock Adjustment			
Date Adjustment			
Demonstration mode setting			
AMP Control			

- iPod is a trademark of Apple, Inc., registered in the U.S. and other countries.
- The "AAC" logo is trademark of Dolby Laboratories.

Before use

▲WARNING

To prevent injury or fire, take the following precautions:

- To prevent a short circuit, never put or leave any metallic objects (such as coins or metal tools) inside the unit.

Before using this unit for the first time

This unit is initially set on the Demonstration mode. When using this unit for the first time, cancel the <Demonstration mode Setting> (page 18).

How to reset your unit

- If this unit or the connected unit (disc auto changer, etc.) fails to operate properly, press the Reset button. The unit returns to factory settings when the Reset button is pressed.

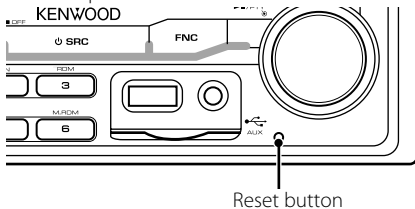

Cleaning the Unit

If the faceplate of this unit is stained, wipe it with a dry soft cloth such as a silicon cloth.

If the faceplate is stained badly, wipe the stain off with a cloth moistened with neutral cleaner, then wipe it again with a clean soft dry cloth.



- Applying spray cleaner directly to the unit may affect its mechanical parts. Wiping the faceplate with a hard cloth or using a volatile liquid such as thinner or alcohol may scratch the surface or erase characters.

Lens Fogging

When you turn on the car heater in cold weather, dew or condensation may form on the lens in the CD player of the unit. Called lens fogging, this condensation on the lens may not allow CDs to play. In such a situation, remove the disc and wait for the condensation to evaporate. If the unit still does not operate normally after a while, consult your Kenwood dealer.

- If you experience problems during installation, consult your Kenwood dealer.
- When you purchase optional accessories, check with your Kenwood dealer to make sure that they work with your model and in your area.
- Characters that conform to ISO 8859-5 or ISO 8859-1 can be displayed. Refer to "MENU" > "Russian" of <Function Control> (page 6).
- The RDS feature won't work where the service is not supported by any broadcasting station.
- In this document, the description indicator will light means a status is displayed. Refer to <About Display Type> (page 9) for the details of the status display.
- The illustrations of the display, the function icon and the panel appearing in this manual are examples used to explain more clearly how the controls are used. Therefore, what appears on the display in the illustrations may differ from what appears on the display on the actual equipment, and some of the illustrations on the display may be inapplicable.

Handling CDs

- Do not touch the recording surface of the CD.
- Do not stick tape etc. on the CD, or use a CD with tape stuck on it.
- Do not use disc type accessories.
- Clean from the center of the disc and move outward.
- When removing CDs from this unit, pull them out horizontally.
- If the CD center hole or outside rim has burrs, use the CD only after removing the burrs with a ballpoint pen etc.

CDs that cannot be used

- CDs that are not round cannot be used.

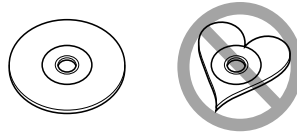

- CDs with coloring on the recording surface or CDs that are dirty cannot be used.

- This unit can only play the CDs with 

This unit may not correctly play discs which do not have the mark.

- You cannot play a CD-R or CD-RW that has not been finalized. (For the finalization process refer to your CD-R/CD-RW writing software, and your CD-R/CD-RW recorder instruction manual.)

Basic Operation

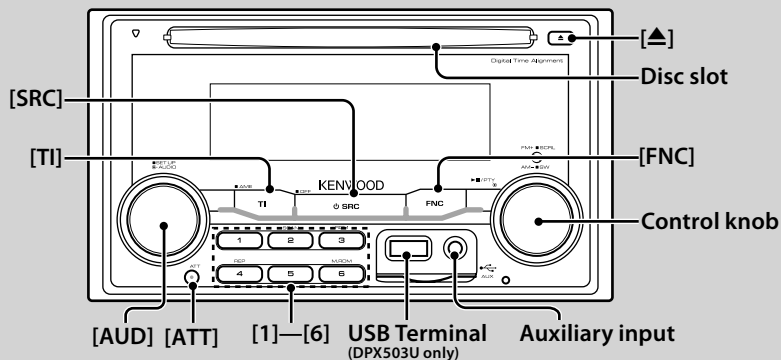

General functions

Power/Source Select button: [SRC]

Turns on the power.

When the power is ON, select a source.

SRC Select mode 1: Press the [SRC] button and then turn the Control knob or push it toward left or right. To determine the selected source, press the Control knob.

SRC Select mode 2: Pressing this button each time switches between sources.

Tuner ("TUNER"), USB or iPod ("USB" or "iPod") (DPX503U only), CD ("Compact Disc"), Auxiliary input ("AUX"), and Standby ("STANDBY")

Press at least 1 second to turn off the power.



- The SRC Select mode can be set in "MENU" > "SRC Select" of <Function Control> (page 6).
- When an optional accessory is connected, the source name for each device appears.
- This unit automatically turns full power OFF after 20 minutes lapses in Standby mode in order to save the vehicle's battery. The time until full power OFF can be set in "Power OFF" of <Function Control> (page 6).
- When connection of the iPod is recognized, the source display changes from "USB" to "iPod". (DPX503U only)

Volume control: [AUD]

Turn the knob to adjust the volume.

Attenuator: [ATT]

Turning the volume down quickly.

When the volume is reduced, the "ATT" indicator flashes.

Muting volume upon reception of phone call

When there is a call, "CALL" is displayed and the audio system is paused.

When the call ends, "CALL" disappears and the audio system comes back on.

The audio system comes back on when [SRC] is pressed during a call.



- To use the TEL Mute feature, you need to hook up the MUTE wire to your telephone using a commercial telephone accessory. Refer to <Connecting Wires to Terminals> (page 31).

Auxiliary input: Auxiliary input

Connect a portable audio device with mini-plug cable (ø3.5 mm).



- Use the mini-plug cable which is stereo type and does not have any resistance.
- The auxiliary input requires the setting made in "MENU" > "Built in AUX" of <Function Control> (page 6).

Subwoofer output: Control knob

Switches between ON ("SUBWOOFER ON") and OFF ("SUBWOOFER OFF") each time pushing toward down for at least 2 seconds.



- This function requires the setting made in "MENU" > "SWPRE" of <Function Control> (page 6).

Function Control: [FNC]

Pressing this button allows you to set various functions using the Control knob. Refer to <Function Control> (page 6).

Category	Function of setup item
MENU	Allows you to set up the environment.
SOUND*	Allows you to set up the sound environment.
DISP	Allows you to set up the display.
COLOR*	Allows you to set up the illumination color.

*Function of DPX503U

Text/Title scroll: Control knob

Scrolls the CD, audio file, and Radio text display when pushing toward up for at least 2 seconds.

Tuner functions

Band select: Control knob

Switches between FM1, FM2, and FM3 each time pushing toward up.

Switches to AM when pushing toward down.

Tuning: Control knob

Changes the frequency when pushing toward left or right.



- During reception of stereo stations the "ST" indicator is ON.

Auto memory entry:[TI]

Memorizes six stations with good reception automatically when pressed for at least 2 seconds.

Preset memory: [1] – [6]

Memorize the station selected when pressing for at least 2 seconds.

Preset tuning: [1] – [6]

Recalls the memorized station.

Traffic Information: [TI]

Turns ON or OFF the Traffic Information function. If traffic bulletin starts when the function is ON, "Traffic INFO" is displayed and traffic information is received.



- If the volume is adjusted during reception of traffic information, the adjusted volume is memorized automatically. The memorized volume will be applied next time the Traffic Information function is turned ON.

Disc & Audio file play functions

Disc play: Disc slot

Starts playing when a disc is inserted.

When a CD is inserted, the "IN" indicator is ON.



- 3 inch (8 cm) CD cannot be used. Attempt to insert using an adapter can cause malfunction.

Disc ejection: [▲]



- You can eject the disc for 10 minutes after switching off the engine.

USB device/iPod play (Function of DPX503U):

USB Terminal

Connecting a USB device starts playback.



- For the playable audio file, media, and devices, refer to <About Audio file> (page 26).

Pause and play: Control knob

Switches between pause and play each time the center is pressed.

USB device removing (DPX503U only): [▲]

Press this button for 2 seconds or longer to select the remove mode, and then remove the USB device.

During the remove mode, the "USB REMOVE" indicator is ON.

Music search: Control knob

Changes the music when pushing toward left or right.

Fast reverses or forwards the music while keeping pushing toward left or right. (No sound is output while playing audio file.)

Folder search: Control knob

Changes the folder containing the audio file when pushing toward up or down.

Track/ File/ Folder repeat play: [4]

Switches between Track Repeat ("Repeat ON") and OFF when pressed while playing a CD.

Switches between File Repeat ("File Repeat ON"), Folder Repeat ("Folder Repeat ON"), and OFF when pressed while playing an audio file.



- The folder repeat operation cannot be performed while iPod is playing.

Scan play: [2]

Successively plays the intro of the music in the disc or folder.

Switches between ON ("Scan ON"/"File Scan ON") and OFF each time this button is pressed.



- The Scan play operation cannot be performed while iPod/"Media Editor" media is playing.

Random play: [3]

Randomly plays the music in the disc or folder.

Switches between ON ("Disc Random ON"/"Folder RDM ON") and OFF each time this button is pressed.

Function Control

Functions in the table below can be set up by using Function Control.

Category	Item	Setting	Entry	Setting overview	Condition	Page
MENU	"Security Set"/ "Security Clear"		1 sec.	Sets/Resets security code	SB	17
	"SRC Select"	"1"/"2"		Sets the source selection method.	SB	27
	"iPod Mode"*1	"OFF"/"ON"*		When set to "ON", allows you to select music in the manner similar to that of the iPod.	iPod	13
	"AT COL CHG"*1	"OFF"/"iPod"*		When the iPod source is used, sets whether the illumination color is changed by the iPod.	iPod	28
	"Beep"	"OFF"/"ON"*		Setting the operation check sound (beep sound) ON/OFF.	SB	
	"Clock Adjust"		1 sec.	Sets the clock.	—	18
	"Date Adjust"		1 sec.	Sets the date.	SB	18
	"Date Mode"	7 types	1 sec.	Sets the date display mode.	SB	
	"SYNC"	"OFF"/"ON"*		Synchronizing the RDS station time data and this unit's clock.	SB	
	"DSI"	"OFF"/"ON"*		A red indicator will blink on the unit after the ACC is set to OFF, warning potential thieves.	SB	
	"Display"	"OFF"/"ON"*		Turns off the display when no operation is performed.	—	27
	"Dimmer"	"OFF"/"ON"*		Dims the display part in conjunction with the light switch of the vehicle.	SB	
	"ILM Dimmer"	"AUTO"/"MNAL"/ "OFF"		Sets whether the illumination is dimmed in conjunction with the light switch of the vehicle or it is dimmed constantly.	SB	27
	"ILM Effect"	"OFF"/"ON"*		Sets whether the illumination color is changed in conjunction with the key operation. (To connect the Bluetooth unit)	SB	
	"ILM MSC SYNC"	"OFF"/"ON"		Sets whether the key illumination color is changed in conjunction with the sound volume.	—	
	"ILM Color"*2	"Blue"/"Red"/ "Green"		Sets the button illumination color.	SB	
	"SWPRE"	"Rear"/"Sub-W"		Sets the preout output.	SB	27
	"AMP"	"OFF"/"ON"*		Turns on/off the built-in amplifier.	SB	27
	"Zone2"	"Rear"/"Front"		Specifies the destination of AUX input sound when the Dual Zone function is turned on.	2ZONE	27
	"Supreme"	"OFF"/"ON"*		Turns ON/OFF the Supreme function.	AF2	27
	"AMS Control"		1 sec.	Controls the connected LX amplifier.	—	18
	"News"	"OFF"/"00min" —"90min"		Turns ON/OFF the News Bulletin Automatic Reception function and sets the news bulletin interrupt disabled time.	SB	28
	"Local Seek"	"OFF"/"ON"		Only stations whose reception is good are searched in auto seek tuning.	FM	
	"Seek Mode"	"Auto1"/"Auto2"/ "Manual"		Selects the tuning mode of the radio.	Tuner	28
	"AF"	"OFF"/"ON"*		When station reception is poor, automatically switches to the station that is broadcasting the same program over the same RDS network.	SB	28
	"Regional"	"OFF"/"ON"*		Sets whether to switch to the station only in the specific region using the "AF" control.	SB	
	"Auto TP Seek"	"OFF"/"ON"*		When traffic information station reception is poor, automatically searches for a station that can be received better.	SB	
"MONO"	"OFF"/"ON"		You can reduce the noise when stereo broadcasts are received as monaural.	FM		
"Name Set"		1 sec.	Sets the disc name (DNPS)/ AUX name.		11/12	

Category	Item	Setting	Entry	Setting overview	Condition	Page
	"Russian"* ³	"OFF"/"ON"*		Selects Russian as the display language.	SB	28
	"Scroll"	"Auto"/"Manual"*		When set to "Auto", scrolls the screen once with the change of the displayed text.	—	
	"Built in AUX"	"OFF"/"ON"*		Sets whether to display AUX during source selection.	SB	
	"Power OFF"	"-----"/"20min"/ "40min"/"60min"		Turns off the power when the preset time has lapsed in the Standby mode.	SB	28
	"CD Read"	"1"/"2"		Sets the CD read mode.	SB	28
	"Audio Preset"* ²		1 sec.	Presets the setting value of the audio control. The preset value is retained after resetting.	SB	24
	"DISP REVERSE"	"POSI 1"/"POSI 2"/ "NEGA 1"/"NEGA 2"		Switches the panel display between positive or negative.	—	
	"CONTRAST"	"1" – "10"		Adjusting the display contrast.	—	
	"OPENING MSGE Edit"		1 sec.	Sets the opening message displayed when the power is turned on.	SB	12
	"DEMO Mode"	"OFF"/"ON"*	2 sec.	Specifies whether to enable demonstration.	—	18
SOUND* ¹	"S-SET"	"CABIN" "Compact1" etc.		Selects the car type to compensate the distance difference between each speaker.	SB	19 /28
		"DTA"		Makes fine adjustment of the compensation value specified at Cabin.	SB	19/29
		"XOVER"		Makes fine adjustment of the X'Over value specified at Speaker.	SB	20
	"S-CTRL"	"EQ"		Sets the sound quality.	SB	20
		"POSIT"		Compensates the sound environment in accordance with the listening position.	SB	20 /21
		"LOUD"	"OFF"/"ON"	Compensates high and low pitch sound at lower volume.	SB	
	"PRESET"			Presets the setting value of the audio control. The preset value is retained after resetting.	SB	21
DISP	"TYPE"	A/ B/ C/ D		Sets the display pattern.	—	9
	"GRAPH"	Spectrum Analyzer 1 – 2		Sets the Type D spectrum analyzer display.	D	
	"SIDE"	Text icon/ Source icon/ OFF		Sets the Type A/B side icon display.	A B	
	"TEXT"			Sets the text display.	A B C	9
	"OUT"			Sets the vehicle-side display.	—	
Color* ¹				Sets the Panel illumination color.	Illumi	10
P.MEM				Presets a station.	➔	15
SCAN		"ON"/ —		When set to "ON", plays the intro of the music in the folder successively.	AF2	
RDM		"ON"/ —		When set to "ON", plays the music in the folder randomly.	AF1	
FiREP		"ON"/ —		When set to "ON", plays the music repeatedly.	AF1	
FOREP		"ON"/ —		When set to "ON", plays the music in the folder repeatedly.	AF2	
SCAN		"ON"/ —		When set to "ON", plays the intro of the music on the disc successively.	DISC	
RDM		"ON"/ —		When set to "ON", plays the music on the disc randomly.	DISC	
M.RDM		"ON"/ —		When set to "ON", plays the music in the disc changer randomly.	CH	
T.REP		"ON"/ —		When set to "ON", plays the music repeatedly.	DISC	
D.REP		"ON"/ —		When set to "ON", plays the music on the disc repeatedly.	CH	

*Factory setting

*¹ Function of DPX503U.

*² Function of DPX303/DPX313.

*³ Function of Russian sales model.

Next page ►

Function Control

Displayed item is depending on currently selected source or mode. The mark in Condition column shows the condition to which the item is displayed.

- SB** : Can be set in other than standby state.
- SB** : Can be set in standby state.
- AF1** : Can be set while Audio file source of CD/USB/iPod.
- AF2** : Can be set while Audio file source of CD/USB (excluding iPod).
- DISC** : Can be set while CD/ Disc changer source.
- CH** : Can be set while Disc changer source.
- Tuner** : Can be set during Tuner source.
- FM** : Can be set during FM reception.
- AUX** : Can be set while accessing AUX source.
- iPod** : Can be set only during playback of the iPod source. (USB source used when the iPod is connected)
- 2ZONE** : Can be set for sources other than the standby source by setting "2 ZONE" of <Audio Setup> (page 23) to "ON".
- Illumi** : Sets "ILM MSC SYNC" and "AT COL CHG" in the menu to "OFF".
- ➔** : Refer to the reference page.
- A-D** : Can be set when the specified type is selected for Display Type.
- : Can be set during all sources.



- Refer to the respective page for information on how to set the items with reference page number.
- Only the items available to the current source are displayed.
- "ILM MSC SYNC" is displayed when "MENU" > "AT COL CHG" in <Function Control> is set to "OFF".
- Location played with "File Scan"
 - Audio file: First 10 seconds
 - Music Editor media: First 10 seconds or the part picked by Intro Skip.
 During Intro Skip, turn the control knob left or right to change the song.
 The scan method depends on the Music Editor setting. See the Music Editor help for details.

1 Enter Function Control mode

Press the [FNC] button.

Function icon is displayed.

2 Select your desired setup item

Operation type	Operation
Movement between items	Turn the Control knob.
Selection of item	Press the Control knob.
Return to previous item	Press the [FNC] button or "◀" icon.

Repeat selection and determination until your desired setup item is selected.

Example:

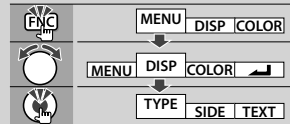

In this manual, the above selection is indicated as

Select "DISP" > "TYPE".

3 Make a setting

Turn the Control knob to select a setting value, and then press the Control knob.

- The value of items with ◀○▶ mark can be set by pushing the Control knob towards right or left.
- Some items require you to keep pressing the Control knob for 1 or 2 seconds so that you can make a setting. For these items, the time during which you need to keep pressing the Control knob is displayed in the Entry column in seconds.
- For the functions accompanied by the description of the setting procedure and so forth, the reference page numbers are displayed.



4 Exit Function Control mode

Press the [FNC] button for at least 1 second.

Display Settings

About Display Type

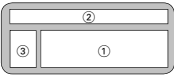
Shown below are examples of display types.

Display	Display Type
"TYPE [A]"	
"TYPE [B]"	
"TYPE [C]"	
"TYPE [D]"	

- ① Text display part
- ② Status display
- ③ Icon display part
- ④ Display (varied depending on the source)
- ⑤ Clock display
- ⑥ Spectrum Analyzer display

Text Display Selection

Changing the text display.

In Tuner source

Information	Display
Program Service name (FM)	"Frequency/PS"/"FREQ/PS"
Title & Artist name* (FM)	"Title/Artist"/"TITLE/ART"
Station name* (FM)	"Station Name"/"ST NAME"
Radio text plus* (FM)	"Radio Text Plus"/"R-TEXT+"
Radio text (FM)	"Radio Text"/"R-TEXT"
Frequency (MW, LW)	"Frequency"/"FREQ"
Spectrum Analyzer & Clock	"Speana/Clock"/"SPEANA"
Date	"Date"/"DATE"
Blank	"Blank"/"BLANK"

* Information of Radio text plus is displayed.

In CD & External disc source

Information	Display
Disc title	"Disc Title"/"D-TITLE"
Track title	"Track Title"/"T-TITLE"
Play time & Track number	"P-Time"/"P-TIME"
Disc name	"DNPS"
Spectrum Analyzer & Clock	"Speana/Clock"/"SPEANA"
Date	"Date"/"DATE"
Blank	"Blank"/"BLANK"

In Audio file source

Information	Display
Music title & Artist name	"Title/Artist"/"TITLE"
Album name & Artist name	"Album/Artist"/"ALBUM"
Folder name	"Folder Name"/"FOLDER"
File name	"File Name"/"FILE"
Play time & Music number	"P-Time"/"P-TIME"
Spectrum Analyzer & Clock	"Speana/Clock"/"SPEANA"
Date	"Date"/"DATE"
Blank	"Blank"/"BLANK"

In Standby

Information	Display
Standby	"Source Name"/"SRC NAME"
Clock	"Clock"/"CLOCK"
Date	"Date"/"DATE"
Blank	"Blank"/"BLANK"

In Auxiliary input source

Information	Display
Auxiliary input name	"Source Name"/"SRC NAME"
Spectrum Analyzer & Clock	"Speana/Clock"/"SPEANA"
Date	"Date"/"DATE"
Blank	"Blank"/"BLANK"

1 Enter Text Display Selection mode (In Display Type A/ B/ C)

Select "DISP" > "TEXT".

For how to select Function Control item, refer to <Function Control> (page 6).

2 Select the text display part

Push the Control knob towards up or down.

The selected text display part blinks.

3 Select the text

Turn the Control knob or push it towards left or right.

4 Exit Text Display Selection mode

Press the [FNC] button.



- If the selected display item does not have any information, alternative information is displayed.
- Some items cannot be selected depending on the display type and row.
- When selecting "Folder Name" while playing with iPod, names will be displayed depending on currently selected browsing items.
- When Display Type C is selected, "Speana" is displayed instead of "Speana/Clock".
- "Frequency" can be selected only on the first line while setting the text.
- When LX-AMP is connected, the item setup by the Display mode of LX-AMP is displayed.

Display Settings

Function of DPX503U

Illumination Color Selection

Selecting the Illumination Color of the panel.

1 Enter Illumination Color Selection mode

Select "Color".

For how to select Function Control item, refer to <Function Control> (page 6).

2 Select the place where you want to set the Illumination Color

Place	Display
All	"All Color"
Display	"Display Color"
Button	"Key Color"
Volume knob	"Left Knob Color"
Control knob	"Right Knob Color"
Save and recall the Illumination Colors you selected for each place	"Color Preset"

Turn the Control knob and push the center when the desired item is displayed.

3 Select the Illumination Color

Turn the Control knob and push the center when the desired item is displayed.

Select the color from "Variable Scan"/"Color1" — "Color 10"/"User".

Creating "User" color

You can create your original color during the selection from "Color1" — "Color10."

The color you created can be called when you select "User".

1. Press the Control knob for at least 1 second.

Enter the detail color adjustment mode.

2. Set the color.

Operation type	Operation
To select the color to adjust. (red, green, or blue)	Push the Control knob towards right or left.
To adjust color. (Range: 0 – 9)	Turn the Control knob or push it towards up or down.

3. Press the Control knob.

Exit the detail color adjustment mode.

4 Exit Key Color Selection mode

Press the [FNC] button.



- When you select "PRESET", you can save the combination of the Illumination Colors selected for each place. For how to save Illumination Colors, refer to <Illumination Color Preset Memory> (page 10).

Function of DPX503U

Illumination Color Preset Memory

Saving the combination of the Illumination Colors selected for each place. The memory cannot be erased by the Reset button.

1 Set the Illumination Color for each place

Refer to <Illumination Color Selection> (page 10).

2 Enter Illumination Color Preset Memory mode

Select "COLOR" > "PRESET" > "MEMO".

For how to select Function Control item, refer to <Function Control> (page 6).

3 Put the Illumination Color Preset in the memory

Press the Control knob.

"Memory?" is displayed.

4 Turn the Control knob to select "YES", and then press the Control knob.

"Memory Completed" is displayed.

5 Exit Illumination Color Preset mode

Press the [FNC] button.



- Register 1 pair of Illumination Color Preset Memory.
- If you press the Reset button, the value in the memory will be default setting value of "Illumination Color Selection."

Illumination Color Preset Recall

Recalling the selection you saved in Illumination Color Preset mode.

1 Enter Audio Preset Recall mode

Select "COLOR" > "PRESET" > "RECALL".

For how to select Function Control item, refer to <Function Control> (page 6).

2 Recall the Illumination Color Preset

Press the Control knob.

"Recall?" is displayed.

3 Turn the Control knob to select "YES", and then press the Control knob.

"Recall Completed" is displayed.

4 Exit Illumination Color Preset Recall mode

Press the [FNC] button.



- When you recall Illumination Color Preset, the current Illumination Color settings will be replaced with the preset selection.

Disc Naming (DNPS)

Attaching a title to a CD.

1 Play the disc you want to attach a name to

2 Select Name set mode item during Menu mode

Select the "Name Set" display.

For how to select Function Control items, refer to <Function Control> (page 6).

3 Enter Name set mode

Press the Control knob for at least 1 second.

4 Enter the name

Operation type	Operation
Move the cursor to the enter character position	Push the Control knob towards right or left.
Select the character type*	Press the Control knob.
Select the characters	Turn the Control knob or push it towards up or down.

- * Each time you press the knob, the character type alternates between the types shown in the table below.

Character type	
Alphabet upper case	
Alphabet lower case	
Numbers and symbols	
Special characters (Accent characters)	



- Enter characters by using a remote control with numbers buttons.

Example: If you are entering "DANCE".

Character	"D"	"A"	"N"	"C"	"E"
Button	[3] [▶▶]	[2] [▶▶]	[6] [▶▶]	[2] [▶▶]	[3]
Times pressed	1	1	2	3	2

5 Exit Menu mode

Press the [FNC] button.



- A title cannot be attached to Audio file media.
- When operation stops for 10 seconds the name at that time is registered, and Name Set mode closes.
- Media that you can attach a name to
 - Internal CD player: 10 discs
 - External CD changer/ player: Varies according to the CD changer/ player. Refer to the CD changer/ player manual.
- You can change the name of a CD by the same operation you used to name it.

Display Settings

Auxiliary Input Display Setting

Selects the display below when changing to Auxiliary input source.

1 Select Auxiliary input display setting item during Menu mode (In AUX mode)

Select the "Name Set" display.

For how to select Function Control items, refer to <Function Control> (page 6).

2 Enter Auxiliary input display setting mode Press the Control knob for at least 1 second.

The presently selected Auxiliary input display is displayed.

3 Select the Auxiliary input display

Turn the Control knob or push it towards up or down.

"AUX"/"DVD"/"PORTABLE"/"GAME"/"VIDEO"/"TV"

4 Exit Auxiliary input display setting mode

Press the [FNC] button.



- When operation stops for 10 seconds, the name at that time is registered, and the Auxiliary input display setting mode closes.
- The Auxiliary input display can be set only when the built-in auxiliary input or the auxiliary input of optional KCA-S220A is used. On the KCA-S220A, "AUX EXT" is displayed by default.

Opening message edit

Setting the opening message to be displayed when the power is turned on.

1 Select Opening message edit item during Menu mode

Select "OPENING MSGE Edit".

For how to select Function Control items, refer to <Function Control> (page 6).

2 Enter Opening message edit mode

Press the Control knob for at least 1 second.

3 Enter the character

Operation type	Operation
Move the cursor to the enter character position	Push the Control knob towards right or left.
Select the character type*	Press the Control knob.
Select the characters	Turn the Control knob or push it towards up or down.

* Each time you press the knob, the character type alternates between the types shown in the table below.

Character type	
	Alphabet upper case
	Alphabet lower case
	Numbers and symbols

4 Press the Control knob for at least 2 seconds.

"Completed" is displayed.

5 Exit Menu mode

Press the [FNC] button.



- The Opening message can be displayed up to 8 characters.

Music disc/Audio file Operation

Function of Audio file/ Internal CD source

Music Select

Selecting the music you want to listen to from the device or media being played now.

1 Enter Music Select mode Turn the Control knob.

The music list is displayed.

2 Search for music Select the category item using the Control knob.

iPod source (when "iPod Mode" is "ON") (Function of DPX503U)

Operation type	Operation
Movement between items	Turn the Control knob.
Selection of item	Press the Control knob.
Return to previous item	Push the Control knob towards up.
Return to first item	Push the Control knob towards up for at least 1 second.

Other source

Audio file (including iPod source while "iPod Mode" is "OFF")

Operation type	Operation
Movement between items	Turn the Control knob or push it towards up or down.
Selection of item	Push the Control knob towards right.
Return to previous item	Push the Control knob towards left.
Return to first item	Push the Control knob towards left for at least 1 second.

Internal CD source

Operation type	Operation
Movement between track	Turn the Control knob or push it towards up or down.
Selection of track	Press the Control knob.
Return to first track	Push the Control knob towards left for at least 1 second.

The "◀" or "▶" symbol shown beside the displayed item indicates that the item is preceded or followed by another item.

Selecting a music will play it from the beginning.

Cancelling Music Select Press the [FNC] button.



- Music Select cannot be performed during Random play.
- Set the iPod mode in "MENU" > "iPod Mode" of <Function Control> (page 6).

Function of remote control

Direct Music Search

Searchs the music by entering the track number.

1 Enter the music number Press the number buttons on the remote control.

2 Search the music Press the [◀◀] or [▶▶] button.

Cancelling Direct Music Search

Press the [▶II] button.



- Direct Music Search cannot be performed during playing of iPod, "Music Editor" media, Random play, or scan play.

Function of disc changers with remote control

Direct Disc Search

Searchs the disc by entering the disc number.

1 Enter the disc number Press the number buttons on the remote control.

2 Search the disc Press the [FM] or [AM] button.

Cancelling Direct Disc Search

Press the [▶II] button.



- Direct Disc Search cannot be performed during playing of Random play or scan play.

Music disc/Audio file Operation

Basic Operation of Disc Changer (Optional)

Selecting CD changer source

Press the [SRC] button.

Select the "CD Changer" display.

For how to select source item, refer to <Power/Source Select button> of <Basic Operation> (page 4).

Music search

Push the Control knob towards right or left.

Disc Search

Push the Control knob towards up or down.

Playing the Current Song or Disc Repeatedly. (Repeat play)

Press the [4] button.

Pressing the button repeatedly selects Track Repeat play on ("Track Repeat ON"), Disc Repeat play on ("Disc Repeat ON"), and Repeat play off ("Repeat OFF") sequentially.

Randomly plays the music in the disc changer. (Magazine random play)

Press the [6] button.

Pressing the button toggles the setting between Magazine random play on ("Magazine RDM ON") and off ("Magazine RDM OFF").

Tuner Operation

Station Preset Memory

Putting a station in the memory.

- 1 Select the frequency to put in the memory**
Push the Control knob towards right or left.
- 2 Enter Preset Memory mode**
Select "P.MEM"
For how to select Function Control item, refer to <Function Control> (page 6).
- 3 Select the number to put in the memory**
Turn the Control knob.
- 4 Determine the number to put in the memory**
Press the Control knob.
- 5 Allow the determined number to take effect**
Press the Control knob.

Canceling the Preset Memory mode

Press the [FNC] button.



- This function can be operated with [1] — [6] button.
Refer to <Basic operation> (page 4).

Preset Tuning

Recalling the stations in the memory.

- 1 Enter Preset Tuning Select mode**
Turn the Control knob.
A station list is displayed.
- 2 Select a desired station in the memory**
Turn the Control knob.
- 3 Recall the station**
Press the Control knob.

Canceling Preset Tuning

Press the [FNC] button.



- This function can be operated with [1] — [6] button.
Refer to <Basic operation> (page 4).

Function of remote control

Direct Access Tuning

Entering the frequency and tuning.

- 1 Enter Direct Access Tuning mode**
Press the [DIRECT] button on the remote control.
"----" is displayed.
- 2 Enter the frequency**
Press the number buttons on the remote control.
Example:

Desired frequency	Press button
92.1 MHz (FM)	[0], [9], [2], [1]
810 kHz (AM)	[0], [8], [1], [0]

Canceling Direct Access Tuning

Press the [DIRECT] button on the remote control.



- You can enter the FM band frequency in steps of a minimum of 0.1 MHz.

Changing Language for PTY Function

Selecting the Program Type display language as follows;

Language	Display	Language	Display
English	"English"	Norwegian	"Norwegian"
Spanish	"Spanish"	Portuguese	"Portuguese"
French	"French"	Swedish	"Swedish"
Dutch	"Dutch"	German	"German"

- 1 Enter PTY mode**
Refer to <PTY (Program Type)> (page 16).
- 2 Enter Changing Language mode**
Press the [TI] button.
- 3 Select the language**
Turn the Control knob or push it towards up or down.
- 4 Exit Changing Language mode**
Press the [TI] button.

Tuner Operation

PTY (Program Type)

Selecting the Program Type below and searching for a station;

Program Type	Display	Program Type	Display
Speech	"All Speech"	Weather	"Weather & Metr"
Music	"All Music"	Finance	"Finance"
News	"News"	Children's programs	"Children's Prog"
Current Affairs	"Current Affairs"	Social Affairs	"Social Affairs"
Information	"Information"	Religion	"Religion"
Sport	"Sport"	Phone In	"Phone In"
Education	"Education"	Travel	"Travel & Touring"
Drama	"Drama"	Leisure	"Leisure & Hobby"
Culture	"Cultures"	Jazz Music	"Jazz Music"
Science	"Science"	Country Music	"Country Music"
Varied	"Varied Speech"	National Music	"National Music"
Pop Music	"Pop Music"	Oldies Music	"Oldies Music"
Rock Music	"Rock Music"	Folk Music	"Folk Music"
Easy Listening Music	"Easy Listening M"	Documentary	"Documentary"
Light Classical	"Light Classic M"		
Serious Classical	"Serious Classics"		
Other Music	"Other Music"		

- Speech and Music include the Program type shown below.
Music: Black character item.
Speech: White character item.

1 Enter PTY mode

Press the Control knob.

"PTY Select" is displayed.

2 Select the Program Type

Turn the Control knob or push it towards up or down.

3 Search for the selected Program Type station

Push the Control knob towards right or left.

4 Exit PTY mode

Press the Control knob.



- This function cannot be used during a traffic bulletin or AM reception.
- When the selected Program Type is not found, "No PTY" is displayed. Select another Program Type.

Program Type preset

Putting the Program Type in the Preset button memory and quick recall.

Presetting the Program Type

1 Select the Program Type to preset

Refer to <PTY (Program Type)> (page 16).

2 Enter Program Type preset mode

Press the [FNC] button.

3 Select the number you want to put in the memory

Turn the Control knob or push it towards left or right.

4 Preset the Program Type

Press the Control knob for at least 1 second.

5 Exit Program Type preset mode

Press the [FNC] button.

Recalling the preset Program Type

1 Enter PTY mode

Refer to <PTY (Program Type)> (page 16).

2 Enter Program Type preset mode

Press the [FNC] button.

3 Select the number you want to recall from the memory

Turn the Control knob or push it towards left or right.

4 Recall the Program Type

Press the Control knob.

5 Exit Program Type preset mode

Press the [FNC] button.

Other Functions

Activating Security Code



- You can set the Security Code with a 4 digit number of your choice.
- The Security Code cannot be displayed or referenced. Make a note of the Security Code and treasure it up.

1 Select Security Code item during Menu mode (In Standby mode)

"Security Set" is displayed.

For how to select Function Control items, refer to <Function Control> (page 6).

2 Enter Security Code mode

Press the Control knob for at least 1 second.

When "Enter" is displayed, "SECURITY SET" is also displayed.

3 Enter Security Code

Operation type	Operation
Select the digits to enter	Push the Control knob towards right or left.
Select the Security Code numbers	Turn the Control knob or push it towards up or down.

4 Confirm the Security Code

Press the Control knob for at least 3 seconds.

When "Re-Enter" is displayed, "SECURITY SET" is also displayed.

5 Do the step 3 through 4 operation, and reenter the Security Code.

"Approved" is displayed.

The Security Code function activates.



- If you enter the wrong Code in steps 3 through 4, repeat from step 3.

6 Exit Security Code mode

Press the [FNC] button.

Entering Security Code

The Security Code is required to use the audio unit when the unit is first used after removed from the battery power source or the Reset button is pressed.

1 Turn the power ON.

2 Do the step 3 through 4 operation, and enter the Security Code.

"Approved" is displayed.

Now, you can use the unit.

Deactivating Security Code

To deactivate the Security Code function.

1 Select Security Code item during Menu mode (In Standby mode)

Select the "Security Clear" display.

For how to select Function Control items, refer to <Function Control> (page 6).

2 Enter Security Code mode

Press the Control knob for at least 1 second.

When "Enter" is displayed, "SECURITY CLEAR" is also displayed.

3 Enter Security Code

Operation type	Operation
Select the digits to enter	Push the Control knob towards right or left.
Select the Security Code numbers	Turn the Control knob or push it towards up or down.

4 Press the Control knob for at least 3 seconds.

"Clear" is displayed.

The Security Code function deactivates.

5 Exit Security Code mode

Press the [FNC] button.



- If a wrong security code is entered, "Error" is displayed. Enter a correct security code.

Other Functions

Manual Clock Adjustment

1 Select Clock Adjustment item during Menu mode

Select the "Clock Adjust" display.
For how to select Function Control items, refer to <Function Control> (page 6).

2 Enter Clock adjustment mode Press the Control knob for at least 1 second.

The clock display blinks.

3 Adjusting Clock

Operation type	Operation
Selecting the item (hours or minutes)	Push the Control knob towards right or left.
Adjust each item	Turn the Control knob or push it towards up or down.

4 Exit Clock adjustment mode Press the [FNC] button.



- You can do this adjustment when "MENU" > "SYNC" in <Function Control> (page 6) is set to "OFF".

Date Adjustment

1 Select Date Adjustment item during Menu mode

Select the "Date Adjust" display.
For how to select Function Control items, refer to <Function Control> (page 6).

2 Enter Date adjustment mode Press the Control knob for at least 1 second.

The date display blinks.

3 Adjusting Date

Operation type	Operation
Selecting the item (month, day, or year)	Push the Control knob towards right or left.
Adjust each item	Turn the Control knob or push it towards up or down.

4 Exit Date adjustment mode Press the [FNC] button.

Demonstration mode setting

Turning the demonstration mode ON/OFF.

1 Select Demonstration item during Menu mode

Select the "DEMO Mode" display.
For how to select Function Control items, refer to <Function Control> (page 6).

2 Set the Demonstration mode Press the Control knob for at least 2 seconds.

Pressing this button for 2 seconds or longer toggles the setting between "ON" and "OFF".

3 Exit Demonstration mode Press the [FNC] button.

When LX AMP unit connecting

AMP Control

You can control the LX AMP connected to the unit.

1 Select AMP Control item during Menu mode

Select the "AMS Control" display.
For how to select Function Control items, refer to <Function Control> (page 6).

2 Enter AMP Control mode Press the Control knob for at least 1 second.

3 Select the AMP Control item for adjustment Push the Control knob towards up or down.



- For the details on the AMP Control item, see the Instruction manual attached to the LX AMP.

4 Adjust the AMP Control item Push the Control knob towards right or left.

5 Exit AMP Control mode Press the [FNC] button.

Audio Adjustments

Function of DPX503U

Cabin selection

You can compensate the delay of the sound arrival time, which is caused by the installation position of the speakers, by selecting your environment from the following car types;

Car type (rear speaker position)	Display
Not compensating.	"OFF"
Compact car (rear door)	"Compact1"
Compact car (cargo)	"Compact2"
Sedan (rear door)	"Sedan1"
Sedan (cargo)	"Sedan2"
Station wagon (rear door)	"Wagon1"
Station wagon (cargo)	"Wagon2"
Minivan (rear door)	"Minivan1"
Minivan (cargo)	"Minivan2"
Sport-utility vehicle (rear door)	"SUV1"
Sport-utility vehicle (cargo)	"SUV2"
Passenger van (rear door)	"PassengerVan1"
Passenger van (cargo)	"PassengerVan2"
Calls the value adjusted at <DTA> (page 19).	"User"

1 Enter Cabin select mode

Select "SOUND" > "S-SET" > "CABIN".

For how to select Function Control item, refer to <Function Control> (page 6).

2 Select the car type

Turn the Control knob and push the center when the desired item is displayed.

3 Exit Cabin select mode

Press the [FNC] button.



- You can compensate the distances in more details by using <DTA> (page 19) function. In addition, the value specified at <DTA> can be called by selecting "User".

Function of DPX503U

DTA (Digital Time Alignment) setting

Adjusting fine tuning of the speaker position compensation value specified at <Cabin selection> (page 19).

1 Enter DTA setting mode

Select "SOUND" > "S-SET" > "DTA".

For how to select Function Control item, refer to <Function Control> (page 6).

2 Select the speaker you want to set

Setting speaker	Display
Front speaker	"DTA-Front"
Rear speaker	"DTA-Rear"
Subwoofer	"DTA-Sub"

Turn the Control knob and push the center when the desired item is displayed.

3 Set the compensation value of the speaker position

Turn the Control knob.

Adjust between 0 and 440 cm.

Refer to <Appendix> (page 29) on how to set the compensation value.

4 Exit DTA setting mode

Press the [FNC] button.

Audio Adjustments

Function of DPX503U

X'Over setting

You can set a X'Over value for the speakers;

Adjustment Item	Display	Range
Front High Pass Filter	"HPF-Front"	Through/40/60/80/100/120/ 150/180/220 Hz
Rear High Pass Filter	"HPF-Rear"	Through/40/60/80/100/120/ 150/180/220 Hz
Low Pass Filter	"LPF"	50/60/80/100/120/Through Hz
Subwoofer level	"SUB-W LEVEL"	-15 — +15
Subwoofer Phase	"SW PHASE"	Reverse (180°)/ Normal (0°)

1 Enter X'Over setting mode

Select "SOUND" > "S-SET" > "XOVER".

For how to select Function Control item, refer to <Function Control> (page 6).

2 Select the item you want to set

Turn the Control knob and push the center when the desired item is displayed.

3 Set the X'Over value

Turn the Control knob.

4 Exit X'Over setting mode

Press the [FNC] button.

Function of DPX503U

Equalizer Control

You can adjust following Equalizer Control items ;

Adjustment Item	Display	Range
System Q	"Preset EQ"	"NATURAL" (Natural)/ "USER" (User setting)/ "ROCK" (Rock)/ "POPS" (Pops)/ "EASY" (Easy)/ "TOP40" (Top 40)/ "JAZZ" (Jazz)/ "GAME" (Game)
Bass level*	"Bass"	-8 — +8
Middle level*	"Middle"	-8 — +8
Treble level*	"Treble"	-8 — +8

* Source tone memory: Puts the set up value in the memory per source.



- "USER": The ranges selected lastly for Bass level, Middle level, and Treble level are recalled automatically.

1 Enter Equalizer Control mode

Select "SOUND" > "S-CTRL" > "EQ".

For how to select Function Control item, refer to <Function Control> (page 6).

2 Select the item you want to set

Turn the Control knob and push the center when the desired item is displayed.

3 Set the value

Turn the Control knob.

4 Exit Equalizer Control mode

Press the [FNC] button.

Function of DPX503U

Preset position selection

According to the listening position, select the position from the following settings so that the normal position of the sound environment can be compensated in accordance with the selected position;

Compensation seat	Range
Not compensating.	"All"
Front-Left seat	"FrontLeft"
Front-Right seat	"FrontRight"
Front seat	"FrontAll"
Calls the value adjusted at <Manual position setting> (page 21).	"USER"

1 Enter Position setting mode

Select "SOUND" > "S-CTRL" > "POSIT" > "P-POSIT".

For how to select Function Control item, refer to <Function Control> (page 6).

2 Select the seat you want to compensate

Turn the Control knob.

3 Exit Position setting mode

Press the [FNC] button.

Manual position setting

Making fine adjustment of the value specified at Preset position selection per speaker.

1 Enter Position setting mode

Select "SOUND" > "S-CTRL" > "POSIT" > "M-POSI".

For how to select Function Control item, refer to <Function Control> (page 6).

2 Select the speaker you want to adjust

Item	Setting overview
"Front Lch"	Front Left speaker
"Front Rch"	Front Right speaker
"Rear Lch"	Rear Left speaker
"Rear Rch"	Rear Right speaker
"Sub Lch"	Subwoofer Left
"Sub Rch"	Subwoofer Right

Turn the Control knob and push the center when the desired item is displayed.

3 Adjust the speaker

Turn the Control knob.

Adjust between 0 and 170 cm.

4 Exit Position setting mode

Press the [FNC] button.



- When you select "User" at <Preset position selection> (page 20), the adjusted setting value will be recalled.

Audio Preset Memory

Registering the value setup by Sound Control. The memory cannot be erased by the Reset button.

1 Setup Sound Control

Refer to the following operations to setup the Sound Control.

- Cabin selection (page 19)
- DTA (Digital Time Alignment) setting (page 19)
- X'Over setting (page 20)
- Equalizer Control (page 20)
- Preset position selection (page 20)
- Manual position setting (page 21)

2 Enter Audio Preset Memory mode

Select "SOUND" > "PRESET" > "MEMO".

For how to select Function Control item, refer to <Function Control> (page 6).

3 Put the Audio Preset in the memory

Press the Control knob.

"Memory?" is displayed.

4 Turn the Control knob to select "YES", and then press the Control knob.

"Memory Completed" is displayed.

5 Exit Audio Preset mode

Press the [FNC] button.



- Register 1 pair of Audio Preset Memory. You cannot register by the source.
- When you press the Reset, all the sources will be the setting value which is registered.

Audio Adjustments

Function of DPX503U

Audio Preset Recall

Recalling the sound setup registered by <Audio Preset Memory> (page 21).

1 Select the source

For how to select source item, refer to <Power/Source Select button> of <Basic Operation> (page 4).

2 Enter Audio Preset Recall mode

Select **"SOUND" > "PRESET" > "RECALL"**.

For how to select Function Control item, refer to <Function Control> (page 6).

3 Recall the Audio Preset

Press the Control knob.

"Recall?" is displayed.

4 Turn the Control knob to select "YES", and then press the Control knob.

"Recall Completed" is displayed.

5 Exit Audio Preset Recall mode

Press the [FNC] button.



- The User memory of "SYSTEM Q" in <Equalizer Control> (page 20) is changed to the value which was recalled.
- The source tone memory item of <Equalizer Control> (page 20) is changed to the value which was recalled by the selected source.

Audio Control

You can adjust following Audio Control items ;

Adjustment Item	Display	Range
Rear volume	"REAR VOLUME"	0 — 35
Subwoofer level*	"SUB-W LEVEL"	-15 — +15
System Q*	"NATURAL"/ "USER"/"ROCK"/ "POPS"/"EASY"/ "TOP40"/"JAZZ"/ "GAME"	Natural/User setting/Rock/ Pops/Easy/Top 40/Jazz/Game
Bass level*	"BASS LEVEL"	-8 — +8
Middle level*	"MIDDLE LEVEL"	-8 — +8
Treble level*	"TREBLE LEVEL"	-8 — +8
Balance	"BALANCE"	Left 15 — Right 15
Fader	"FADER"	Rear 15 — Front 15

Exit Audio Control mode (Volume control mode)

*Function of DPX303/DPX313.



- Source tone memory: You can set Bass, Middle, and Treble for each source.
- "USER": The ranges selected lastly for Bass level, Middle level, and Treble level are recalled automatically.

1 Select the source to adjust

For how to select source item, refer to <Power/Source Select button> of <Basic Operation> (page 4).

2 Enter Audio Control mode

Press the [AUD] knob.

3 Select the Audio item to adjust

Press the [AUD] knob.

4 Adjust the Audio item

Turn the [AUD] knob.

5 Exit Audio Control mode

Press any button.

Press a button other than the [AUD] knob or [▲] and [ATT] button.

Audio Setup

You can set Sound system , such as follows;

Adjustment Item	Display	Range
Front High Pass Filter*	"HPF-F"	Through/40/60/80/100/120/ 150/180/220 Hz
Rear High Pass Filter*	"HPF-R"	Through/40/60/80/100/120/ 150/180/220 Hz
Low Pass Filter*	"LPF"	50/60/80/100/120/Through Hz
Subwoofer Phase*	"SW PHASE"	Reverse (180°)/ Normal (0°)
Volume offset	"VOL-OFFSET"	-8 — ±0 (AUX: -8 — +8)
Loudness*	"LOUD"	OFF/ON
Dual Zone System	"2 ZONE"	OFF/ON

*Function of DPX303/DPX313.



- Volume offset: Sets each source's volume as a difference from the basic volume.
- Loudness: Compensates for low and high tones during low volume. (Only the low tone is compensated for when the tuner is selected as a source.)
- Dual Zone System
Main source and sub source (Auxiliary input) output Front channel and Rear channel separately.
 - Set up the channel of sub source by "Zone2" of <Function Control> (page 6).
 - Select Main source by [SRC] button.
 - Adjust the volume of Front channel by [AUD] knob.
 - Adjust the volume of Rear channel by <Audio Control> (page 22) or [▲]/[▼] button on the remote control (page 25).
 - The Audio Control has no effect on sub source.

1 Select the source to adjust

For how to select source item, refer to <Power/ Source Select button> of <Basic Operation> (page 4).

2 Enter Audio Setup mode

Press the [AUD] knob for at least 1 second.

3 Select the Audio Setup item to adjust

Press the [AUD] knob.

4 Adjust the Audio setup item

Turn the [AUD] knob.

5 Exit Audio Setup mode

Press the [AUD] knob for at least 1 second.

Speaker Setting

Fine-tuning so that the System Q value is optimal when setting the speaker type as follows;

Speaker type	Display
OFF	"OFF"
For 5 & 4 in. speaker	"5/4inch"
For 6 & 6x9 in. speaker	"6x9/6inch"
For the OEM speaker	"O.E.M."

1 Enter Standby

Select the "STANDBY" display.

For how to select source item, refer to <Power/ Source Select button> of <Basic Operation> (page 4).

2 Enter Speaker Setting mode

Press the [AUD] knob.

"SP SEL" is displayed.

3 Select the Speaker type

Turn the [AUD] knob.

4 Exit Speaker Setting mode

Press the [AUD] knob.

Audio Adjustments

Function of DPX303/DPX313

Audio Preset Memory

Registering the value setup by Sound Control. The memory cannot be erased by the Reset button.

1 Setup Sound Control

Refer to the following operations to setup the Sound Control.

- <Audio Control> (page 22)
- <Audio Setup> (page 23)

2 Select Audio Preset item during Menu mode (Other than Standby mode)

Select the "Audio Preset" display.

For how to select Function Control items, refer to <Function Control> (page 6).

3 Enter Audio Preset mode

Press the Control knob for at least 1 second.

4 Select the Audio Preset Memory

Turn the Control knob.

Select the "Memory" display.

5 Determine whether to put the Audio Preset in the memory

Press the Control knob.

"Memory?" is displayed.

6 Put the Audio Preset in the memory

Turn the Control knob to select "YES", and then press the Control knob.

"Memory Completed" is displayed.

7 Exit Audio Preset mode

Press the [FNC] button.



- Register 1 pair of Audio Preset Memory. You cannot register by the source.
- When you press the Reset, all the sources will be the setting value which is registered.
- The following items cannot be registered.
Volume, Balance, Fader, Loudness, Volume offset, Dual Zone System, Rear Volume

Function of DPX303/DPX313

Audio Preset Recall

Recalling the sound setup registered by <Audio Preset Memory> (page 24).

1 Select the source

For how to select source item, refer to <Power/Source Select button> of <Basic Operation> (page 4).

2 Select Audio Preset item during Menu mode (Other than Standby mode)

Select the "Audio Preset" display.

For how to select Function Control items, refer to <Function Control> (page 6).

3 Enter Audio Preset mode

Press the Control knob for at least 1 second.

4 Select the Audio Preset Recall

Turn the Control knob.

Select the "Recall" display.

5 Determine whether to recall the Audio Preset

Press the Control knob.

"Recall?" is displayed.

6 Recall the Audio Preset

Turn the Control knob to select "YES", and then press the Control knob.

"Recall Completed" is displayed.

7 Exit Audio Preset mode

Press the [FNC] button.



- The User memory of "SYSTEM Q" in <Audio Control> (page 22) is changed to the value which was recalled.
- The source tone memory item of <Audio Control> (page 22) is changed to the value which was recalled by the selected source.

Basic Operations of remote control

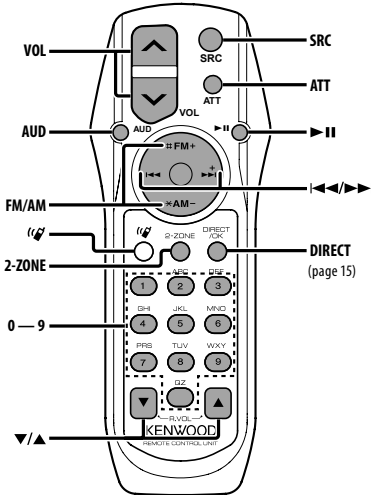

General control

- Volume control [VOL]
- Source select [SRC]
- Volume reduce [ATT]

In Audio control

- Audio item select [AUD]
- Adjusts the Audio item [VOL]



- Refer to <Audio Control> (page 22) for the operation method, such as the procedures for Audio control and others operations.

Dual Zone control

- Dual zone system on and off [2-ZONE]
- Rear channel volume control [▲]/[▼]

In Tuner source

- Band select [FM]/[AM]
- Station select [◀]/[▶]
- Recall preset stations [1] — [6]

In CD/USB source

- Music select [◀]/[▶]
- Folder/Disc select [FM]/[AM]
- Pause/Play [▶||]



About [About]

This button is used when Bluetooth HANDS FREE BOX is connected. For more information, refer to the instruction manual of Bluetooth HANDS FREE BOX.



- Do not set the remote control in hot places such as on the dashboard.

Loading and Replacing battery

Use two "AA"/"R6"-size batteries. Slide the cover while pressing downwards to remove it as illustrated. Insert the batteries with the + and - poles aligned properly, following the illustration inside the case.

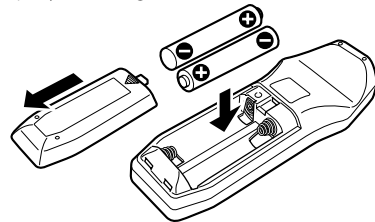

Appendix

About Audio file

- **Playable Audio file**
AAC-LC (.m4a), MP3 (.mp3), WMA (.wma)
- **Playable disc media**
CD-R/RW/ROM
- **Playable disc file format**
ISO 9660 Level 1/2, Joliet, Romeo, Long file name.
- **USB device Playable Model**
DPX503U
- **Playable USB device**
USB mass storage class
- **Playable USB device file system**
FAT16, FAT32

Although the audio files are complied with the standards listed above, the play maybe impossible depending on the types or conditions of media or device.

• Playing order of the Audio file

In the example of folder/file tree shown below, the files are played in the order from ① to ⑩.

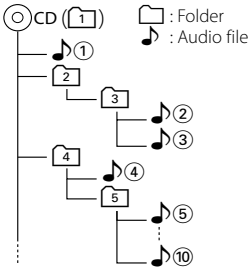

An online manual about audio files is put on the site, www.kenwood.com/audiofile/. On this online manual, detailed information and notes which are not written in this manual are provided. Make sure to read through the online manual as well.



- In this manual, the word "USB device" is used for flash memories and digital audio players which have USB terminals.
- The word "iPod" appearing in this manual indicates the iPod connected with the iPod connection cable (optional accessory). The iPod connected with the iPod connection cable can be controlled from this unit. iPods that can be connected with the iPod connection cable are the iPod nano, Fifth Generation iPod, iPod classic, and iPod touch. Other iPods cannot be connected.

About USB device

- If you start playback after connecting the iPod, the music that has been played by the iPod is played first.
In this case, "RESUMING" is displayed without displaying a folder name, etc. Changing the browse item will display a correct title, etc.
- When the iPod is connected to this unit, "KENWOOD" or "✓" is displayed on the iPod to indicate that you cannot operate the iPod.
- When the USB device is connected to this unit, it can be charged up provided that this unit is powered.
- Install the USB device in the place where it will not prevent you from driving your vehicle properly.
- You cannot connect a USB device via a USB hub and Multi Card Reader.
- Take backups of the audio files used with this unit. The files can be erased depending on the operating conditions of the USB device. We shall have no compensation for any damage arising out of erasure of the stored data.
- No USB device comes with this unit. You need to purchase a commercially available USB device.
- When connecting the USB device, usage of the CA-U1EX (option) is recommended. Normal playback is not guaranteed when a cable other than the USB compatible cable is used. Connecting a cable whose total length is longer than 5 m can result in abnormal playback.

About KENWOOD "Music Editor" of PC application

- "Music Editor" is recorded in the CD-ROM attached to this unit.
- Refer to the user's manual recorded in the installation CD-ROM and Help of "Music Editor" for the operation method of "Music Editor".
- The unit can play USB device created by "Music Editor".
- Information about "Music Editor" upgrade is put on the site, www.kenwood.com.

For operating KCA-BT100 (Optional)

However, the following control methods of the function for this unit may be different from the Instruction manual; therefore, refer to the following supplemental instruction.

<Deleting a Registered Cell-Phone>

1-3. Operation is the same. Refer to the instruction manual of KCA-BT100.

4. Press the Control knob.
5. Select "YES" using the Control knob.
6. Press the Control knob.
7. Press the [FNC] button.

<Menu System>

For how to operate Menu, refer to <Function Control> in this instruction manual.

About display

Cell-Phone Status is displayed in the status display of this unit.

Moreover, some displays are different from the description of KCA-BT100 Instruction Manual.

Displays of KCA-BT100 Instruction Manual	Actual displays on this unit
"Disconnect"	"HF Disconnect"
"Connect"	"HF Connect"
"Phone Delete"	"Device Delete"
"Phone Status"	"BT DVC Status"

BT : Displays the bluetooth connection status.
This indicator turns on when a cell-phone is connected to this unit.

Function Control Glossary

- **SRC Select**
Setting up the Source Select mode.
1 : Displays source icons for your choice.
2 : Allows you to select sources one after another.
- **Display**
If this unit is not operated at least 5 seconds with "OFF" selected, the display turns off. During a setup mode, the display will not turn off even if 5 seconds lapse.
- **ILM Dimmer (illumination dimmer)**
Reduces the key illumination brightness.
AUTO: Dims the illumination in conjunction with the Light switch of the vehicle.
MNAL: Dims the illumination constantly.
OFF: Does not dim the illumination.
- **AT COL CHG (Automatic illumination color change)**
Selecting "iPod" changes the key illumination automatically according to the color of the iPod body during playback of the iPod source.
* The color of key illumination is only a recommended color by our company. It does not necessarily match the body color of iPod.
Compatible iPod models:
iPod (5th generation), iPod classic, iPod touch, iPod nano (1st/2nd/3rd generation), Fifth Generation iPod (iPod with video)
- **SWPRE (Switching Preout)**
Switches the preout between rear output ("Rear") and subwoofer output ("Sub-W").
- **AMP**
Selecting "OFF" turns off the built-in amplifier. Turning off the built-in amplifier improves the quality of the sound from Preout.
Selecting "OFF" disables the functions of the Dual Zone and KCA-BT100 (optional accessory) because no sound will be output from the front speakers.
- **Zone2 (Dual Zone)**
Set the destination (front speaker "Front" or rear speaker "Rear") of the sub source (AUX IN) when the Dual Zone function is turned on.
- **Supreme**
Technology to extrapolate and supplement with proprietary algorithm, the high-frequency range that is cut off when encoding at low bit rate (less than 128Kbps, Sampling frequency is 44.1kHz). Supplementing is optimized by compression format (AAC, MP3 or WMA) and processed according to bit rate.
The effect is negligible with music that is encoded at high bit rate, variable bit rate or has minimal high frequency range.

Appendix

- **News (News Bulletin with Timeout Setting)**

Automatically receives news bulletin when it starts. Set the time during which interrupt is to be disabled after start of another news bulletin. Changing “News 00min” to “News 90min” turns this function ON.

If news bulletin starts when this function is ON, “Traffic INFO” is displayed and news is received. If “20min” is has been set, reception of another news bulletin will not start for 20 minutes.

The news bulletin volume is the same level that was set for Traffic Information.

- **Seek Mode (Tuning mode select)**

Select a tuning mode of the radio.

Tuning mode	Display	Operation
Auto seek	“Auto1”	Automatic search for a station.
Preset station seek	“Auto2”	Search in order of the stations in the Preset memory.
Manual	“Manual”	Normal manual tuning control.

- **AF (Alternative Frequency)**

When the reception is poor, automatically alternate to another frequency broadcasting the same program in the same RDS network with better reception.

- **Russian (Russian language setting)**

When this is set to ON, the following character strings are displayed in Russian:
Folder name/ File name/ Song title/ Artist name/
Album name/ KCA-BT100 (optional accessory)

- **Power OFF (Power OFF Timer)**

Setting the timer to turn this unit’s power OFF automatically when Standby mode continues. Using this setting can save the vehicle’s battery power.

– – -: Power OFF Timer function is OFF.

20min: Turns the power OFF after 20 minutes.
(Factory setting)

40min: Turns the power OFF after 40 minutes.

60min: Turns the power OFF after 60 minutes.

- **CD Read**

Sets the method for reading CD.

When unable to play special format CD, set this function to “2” to force playing. Note that some music CD may be unplayable even when set to “2”. In addition, audio files cannot be played when set to “2”. Normally, keep this set to “1”.

1 : Automatically distinguishes between audio file disc and music CD when playing disc.

2 : Forces playing as music CD.

- **DISP REVERSE**

Switches the panel display between positive or negative. In addition, you can reverse it in conjunction with the interior light.

POSI 1 : Displays the text in the positive.

POSI 2 : When the interior light is off, the text is displayed in the positive; when the interior light is on, the text is displayed in the negative.

NEGA 1 : Displays the text in the negative.

NEGA 2 : When the interior light is off, the text is displayed in the negative; when the interior light is on, the text is displayed in the positive.

- **Cabin**

The position of front and rear speakers may not have the same distance from the center of the vehicle interior.

For example, when a car type has the front speaker nearer to the center of the vehicle interior than the rear speaker, you hear a delayed sound from the rear speaker.

This function allows the sound of the nearer speaker to the center of the vehicle interior to be output with delays and compensates the sound arrival time from the front and rear speakers to be heard at the same time.

The sound arrival time can be compensated simply by selecting the car type you want to use, because the compensation values for typical cars have been preset.

You can specify the more suitable compensation values for your vehicle by using <DTA> (page 19) function.

You can also compensate the listening positions (such as front and rear) in accordance with scenes by specifying the positions at <Preset position selection> (page 20).

- **DTA (Digital Time Alignment)**

Make fine adjustment of the delay time of the speaker output specified at <Cabin selection> (page 19) to have a more suitable environment for your vehicle.

The settings of the delay time are automatically identified and compensated by specifying the distances of each speaker from the center of the vehicle interior.

- 1 Set the front and rear positions and the height of the reference point to the position of the ears of the person sitting in the front seat, and set the right and left positions to the center of the vehicle interior.
- 2 Measure the distances from the reference point to the speakers.
- 3 Calculate the distance difference in accordance with the farthest speaker.

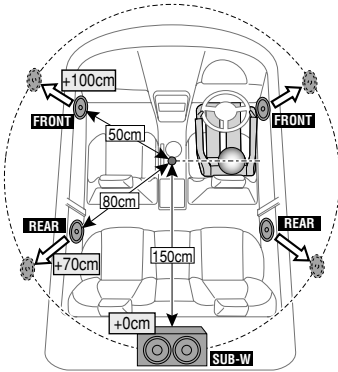

This Product is not installed by the manufacturer of a vehicle on the production line, nor by the professional importer of a vehicle into an EU Member State.

Information on Disposal of Old Electrical and Electronic Equipment and Batteries (applicable for EU countries that have adopted separate waste collection systems)



Products and batteries with the symbol (crossed-out wheeled bin) cannot be disposed as household waste.



Old electrical and electronic equipment and batteries should be recycled at a facility capable of handling these items and their waste byproducts.



Contact your local authority for details in locating a recycle facility nearest to you. Proper recycling and waste disposal will help conserve resources whilst preventing detrimental effects on our health and the environment.

Pb

Notice: The sign "Pb" below the symbol for batteries indicates that this battery contains lead.

The marking of products using lasers (Except for some areas)



The label is attached to the chassis/case and says that the component uses laser beams that have been classified as Class 1. It means that the unit is utilizing laser beams that are of a weaker class. There is no danger of hazardous radiation outside the unit.

Accessories/ Installation Procedure

Accessories

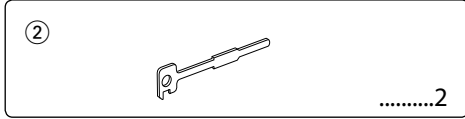
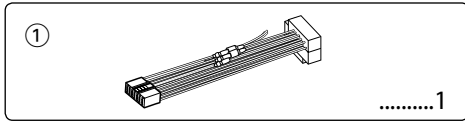

Installation Procedure

1. To prevent short circuits, remove the key from the ignition and disconnect the ⊖ terminal of the battery.
2. Make the proper input and output wire connections for each unit.
3. Connect the wire on the wiring harness.
4. Take Connector B on the wiring harness and connect it to the speaker connector in your vehicle.
5. Take Connector A on the wiring harness and connect it to the external power connector on your vehicle.
6. Connect the wiring harness connector to the unit.
7. Install the unit in your car.
8. Reconnect the ⊖ terminal of the battery.
9. Press the reset button.



- Mounting and wiring this product requires skills and experience. For safety's sake, leave the mounting and wiring work to professionals.
- Make sure to ground the unit to a negative 12V DC power supply.
- Do not install the unit in a spot exposed to direct sunlight or excessive heat or humidity. Also avoid places with too much dust or the possibility of water splashing.
- Do not use your own screws. Use only the screws provided. If you use the wrong screws, you could damage the unit.
- If the power is not turned ON ("Protect" is displayed), the speaker wire may have a short-circuit or touched the chassis of the vehicle and the protection function may have been activated. Therefore, the speaker wire should be checked.
- Make sure that all wire connections are securely made by inserting jacks until they lock completely.
- If your vehicle's ignition does not have an ACC position, or if the ignition wire is connected to a power source with constant voltage such as a battery wire, the power will not be linked with the ignition (i.e., it will not turn on and off along with the ignition). If you want to link the unit's power with the ignition, connect the ignition wire to a power source that can be turned on and off with the ignition key.
- Use a commercially available conversion connector if the connector does not fit in the vehicle connector.
- Insulate unconnected wires with vinyl tape or other similar material. To prevent a short circuit, do not remove the caps on the ends of the unconnected wires or the terminals.
- If the console has a lid, make sure to install the unit so that the faceplate will not hit the lid when closing and opening.
- If the fuse blows, first make sure the wires aren't touching to cause a short circuit, then replace the old fuse with one with the same rating.
- Connect the speaker wires correctly to the terminals to which they correspond. The unit may be damaged or fail to work if you share the ⊖ wires or ground them to any metal part in the car.
- After the unit is installed, check whether the brake lamps, blinkers, wipers, etc. on the car are working properly.
- Mount the unit so that the mounting angle is 30° or less.

About CD players/disc changers connected to this unit

If the CD player/ disc changer has the "O-N" switch, set it to the "N" position.

The functions you can use and the information that can be displayed may differ depending on the models being connected.

Connecting Wires to Terminals

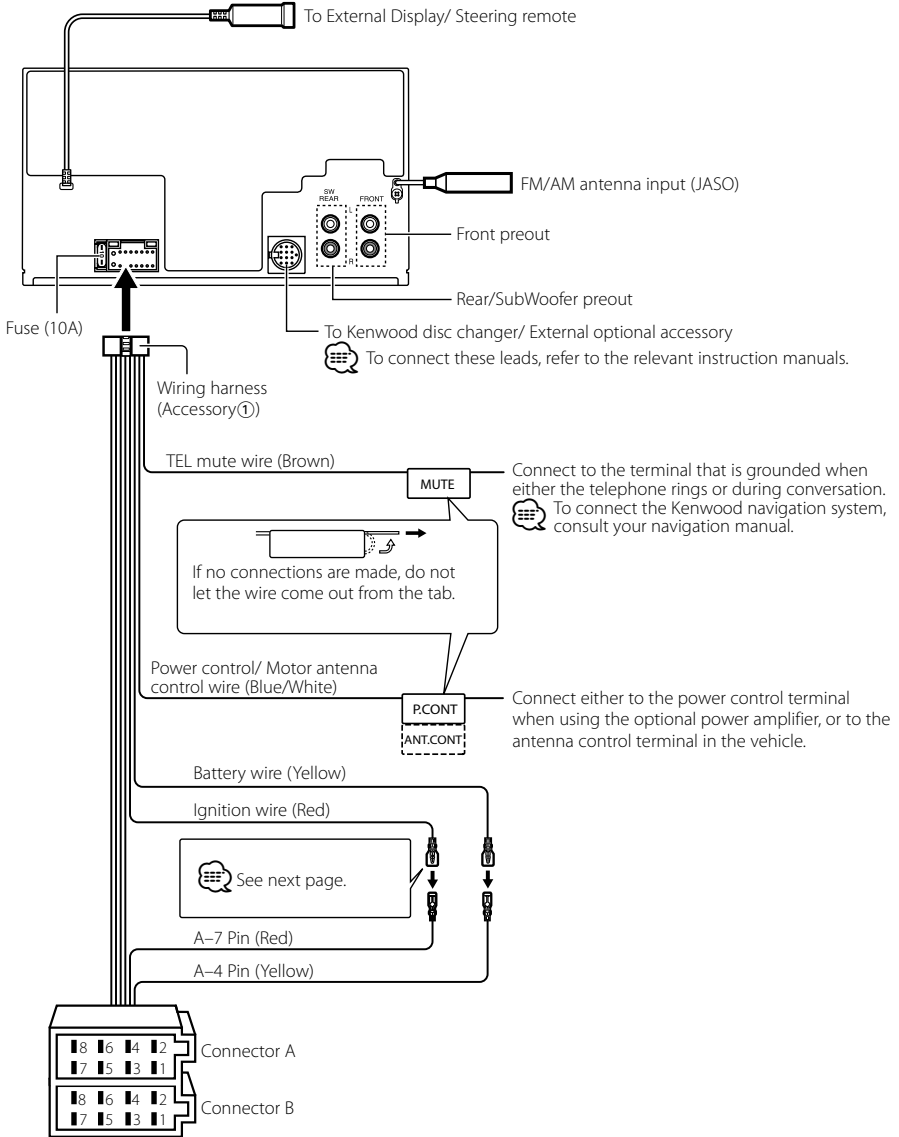

Connecting Wires to Terminals

Connector Function Guide

Pin Numbers for ISO Connectors	Cable Colour	Functions
External Power Connector		
A-4	Yellow	Battery
A-5	Blue/White	Power Control
A-6	Orange/White	Dimmer
A-7	Red	Ignition (ACC)
A-8	Black	Earth (Ground) Connection
Speaker Connector		
B-1	Purple	Rear Right (+)
B-2	Purple/Black	Rear Right (-)
B-3	Gray	Front Right (+)
B-4	Gray/Black	Front Right (-)
B-5	White	Front Left (+)
B-6	White/Black	Front Left (-)
B-7	Green	Rear Left (+)
B-8	Green/Black	Rear Left (-)

▲WARNING

Connecting the ISO Connector

The pin arrangement for the ISO connectors depends on the type of vehicle you drive. Make sure to make the proper connections to prevent damage to the unit.

The default connection for the wiring harness is described in [1] below. If the ISO connector pins are set as described in [2], make the connection as illustrated.

Please be sure to reconnect the cable as shown [2] below to install this unit to the **Volkswagen** vehicles etc.

[1] (Default setting) The A-7 pin (red) of the vehicle's ISO connector is linked with the ignition, and the A-4 pin (yellow) is connected to the constant power supply.

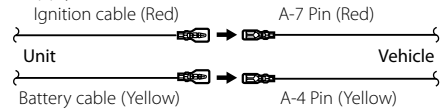

[2] The A-7 pin (red) of the vehicle's ISO connector is connected to the constant power supply, and the A-4 pin (yellow) is linked to the ignition.

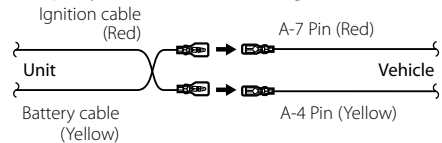

Installation/Removing the Unit

Installation

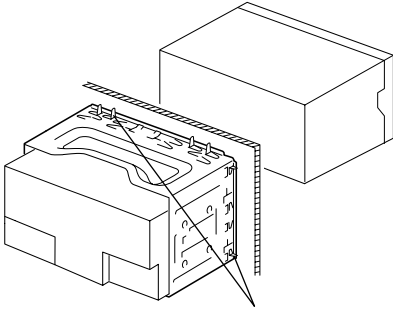

Bend the tabs of the mounting sleeve with a screwdriver or similar utensil and attach it in place.



- Make sure that the unit is installed securely in place. If the unit is unstable, it may malfunction (for example, the sound may skip).

Removing the hard rubber frame

- 1 Engage the catch pins on the removal tool and remove the two locks on the upper level. Upper the frame and pull it forward as shown in the figure.

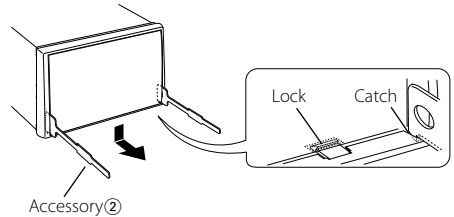

- 2 When the upper level is removed, remove the lower two locations.



- The frame can be removed from the bottom side in the same manner.

Removing the Unit

- 1 Refer to the section <Removing the hard rubber frame> and then remove the hard rubber frame.
- 2 Insert the two removal tools deeply into the slots on each side, as shown.
- 3 Lower the removal tool toward the bottom, and pull out the unit halfway while pressing towards the inside.

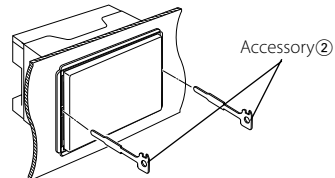

- Be careful to avoid injury from the catch pins on the removal tool.
- 4 Pull the unit all the way out with your hands, being careful not to drop it.

Troubleshooting Guide

Some functions of this unit may be disabled by some settings made on this unit.

- !** • **Cannot set up the subwoofer.**
- **Cannot set up the High Pass Filter.**
- **Cannot set up the Fader.**
- **No Audio control effect on AUX.**
- **Cannot set up the subwoofer position of Manual position setting.**
 - ▶ Preout is not set to subwoofer. **☞** "MENU" > "SWPRE" of <Function Control> (page 6)
 - <Subwoofer output> of <Basic Operation> (page 4) is not set to On.
 - The Dual zone function is enabled. **☞** <Audio Setup> (page 23)

- !** • **Cannot set up the subwoofer phase.**
 - ▶ The Low Pass Filter is set to Through. **☞** <Audio Setup> (page 23), <X'Over setting> (page 20)

- !** • **Cannot select the output destination of the subsource in the Dual zone.**
- **Cannot adjust the volume of the rear speakers.**
 - ▶ The Dual zone function is disabled. **☞** <Audio Setup> (page 23)

- !** • **Cannot register a security code.**
- **Cannot set up Display Illumination Control.**
- **Cannot set up the Power-off timer.**
 - ▶ <Demonstration mode Setting> (page 18) is not turned off.

What might seem to be a malfunction in your unit may just be the result of slight misoperation or miswiring. Before calling service, first check the following table for possible problems.

General

? The Touch Sensor Tone does not sound.

- ✓ The preout jack is being used.
 - ☞** The Touch Sensor Tone cannot be output from the preout jack.

? The illumination flashes when the knob or button is operated.

- ✓ This is the key illumination effect.
 - ☞** You set this effect in "MENU" > "ILM Effect" of <Function Control> (page 6).

? The key illumination effect brought about in conjunction with the sound volume is small.

- ✓ The key illumination effect may be insufficient depending on the sound volume and sound quality.

Tuner source

? Radio reception is poor.

- ✓ The car antenna is not extended.
 - ☞** Pull the antenna out all the way.

Disc source

? The specified disc does not play, but another one plays instead.

- ✓ The specified CD is quite dirty.
 - ☞** Clean the CD, referring to the CD cleaning of the section on <Handling CDs> (page 3).
- ✓ The disc is loaded in a different slot from that specified.
 - ☞** Eject the disc magazine and check the number for the specified disc.
- ✓ The disc is severely scratched.
 - ☞** Try another disc instead.

Audio file source

? The sound skips when an Audio file is being played.

- ✓ The media is scratched or dirty.
 - ☞** Clean the media, referring to the CD cleaning of the section on <Handling CDs> (page 3).
- ✓ The recording condition is bad.
 - ☞** Record the media again or use another media.

? Noise is heard when carrying out Folder Search.

- ✓ Noise may be produced if folders without audio files exist continuously in the playing media.
 - ☞** Do not make folders without audio files.

The messages shown below display your systems condition.

- TOC Error:**
- No disc has been loaded in the disc magazine.
 - The CD is quite dirty. The CD is upside-down. The CD is scratched a lot.
- Error 05:** The disc is unreadable.
- Error 77:** The unit is malfunctioning for some reason.
- ✦ Press the reset button on the unit. If the "Error 77" code does not disappear, consult your nearest service center.
- Mecha Error/ Mecha ERR:**
- Something is wrong with the disc magazine. Or the unit is malfunctioning for some reason.
- ✦ Check the disc magazine. And then press the reset button on the unit. If the "Mecha Error" code does not disappear, consult your nearest service center.
- IN (Blink):** The CD player section is not operating properly.
- ✦ Reinsert the CD. If the CD cannot be ejected or the display continues to flash even when the CD has been properly reinserted, please switch off the power and consult your nearest service center.
- Protect:** The speaker wire has a short-circuit or touches the chassis of the vehicle, and then the protection function is activated.
- ✦ Wire or insulate the speaker cable properly and press the reset button. If the "Protect" code does not disappear, consult your nearest service center.
- Unsupported File:**
- An Audio file is played with a format that this unit can't support.
- Copy Protect/ Copy Protection/ COPY PRO:**
- A copy-protected file is played.
- Read Error:** The file system of the connected USB device is broken.
- ✦ Copy the files and folders for the USB device again. If the error message is still displayed, initialize the USB device or use other USB devices.
- No Device:** The USB device is selected as a source although no USB device is connected.
- ✦ Change the source to any source other than USB. Connect an USB device, and change the source to USB again.
- N/A Device:** An unsupported USB device is connected.
- No Music Data/ No Music/ Error 15:**
- The connected USB device contains no playable audio file.
 - Media was played that does not have data recorded that the unit can play.
- USB ERROR (Blink):**
- Some trouble may have occurred to the connected USB device.
- ✦ Remove the USB device, then cycle the power switch to ON. If the same display is repeated, use another USB device.
- iPod Error:** Connection to the iPod has failed.
- ✦ Check that the connected iPod is an iPod that is supported. See <About Audio file> (page 26) for information on supported iPods.
 - ✦ Remove the USB device and then reconnect it.
 - ✦ Confirm that the software for the iPod is the latest version.
- USB REMOVE:** The Remove mode has been selected for the USB device/iPod. You can remove the USB device/iPod safely.

Specifications

FM tuner section

- Frequency range (50 kHz space)
 - : 87.5 MHz – 108.0 MHz
- Usable sensitivity (S/N = 26dB)
 - : 0.7 μ V/75 Ω
- Quieting Sensitivity (S/N = 46dB)
 - : 1.6 μ V/75 Ω
- Frequency response (\pm 3.0 dB)
 - : 30 Hz – 15 kHz
- Signal to Noise ratio (MONO)
 - : 65 dB
- Selectivity (DIN) (\pm 400 kHz)
 - : \geq 80 dB
- Stereo separation (1 kHz)
 - : 35 dB

MW tuner section

- Frequency range (9 kHz space)
 - : 531 kHz – 1611 kHz
- Usable sensitivity (S/N = 20dB)
 - : 25 μ V

LW tuner section

- Frequency range
 - : 153 kHz – 281 kHz
- Usable sensitivity (S/N = 20dB)
 - : 45 μ V

CD player section

- Laser diode
 - : GaAlAs
- Digital filter (D/A)
 - : 8 Times Over Sampling
- D/A Converter
 - : 24 Bit
- Spindle speed
 - : 500 – 200 rpm (CLV)
- Wow & Flutter
 - : Below Measurable Limit
- Frequency response (\pm 1 dB)
 - : 10 Hz – 20 kHz
- Total harmonic distortion (1 kHz)
 - : 0.008 %
- Signal to Noise ratio (1 kHz)
 - : 105 dB
- Dynamic range
 - : 93 dB
- MP3 decode
 - : Compliant with MPEG-1/2 Audio Layer-3
- WMA decode
 - : Compliant with Windows Media Audio
- AAC decode
 - : AAC-LC “m4a” files

USB Interface (DPX503U)

- USB Standard
 - : USB1.1/ 2.0
- Maximum Supply current
 - : 500 mA
- File System
 - : FAT16/ 32
- MP3 decode
 - : Compliant with MPEG-1/2 Audio Layer-3
- WMA decode
 - : Compliant with Windows Media Audio
- AAC decode
 - : AAC-LC “m4a” files

Audio section

- Maximum output power
 - : 50 W x 4
- Full Bandwidth Power (PWR DIN45324, +B=14.4V)
 - : 30 W x 4
- Speaker Impedance
 - : 4 – 8 Ω
- Tone action
 - Bass : 100 Hz \pm 8 dB
 - Middle : 1 kHz \pm 8 dB
 - Treble : 10 kHz \pm 8 dB
- Preout level / Load (CD)
 - : 2500 mV/10 k Ω
- Preout impedance
 - : \leq 600 Ω

Auxiliary input

- Frequency response (\pm 1 dB)
 - : 20 Hz – 20 kHz
- Input Maximum Voltage
 - : 1200 mV
- Input Impedance
 - : 100 k Ω

General

- Operating voltage (11 – 16V allowable)
 - : 14.4 V
- Current consumption
 - : 10 A
- Installation Size (W x H x D)
 - : 182 x 112 x 160 mm
- Weight
 - : 1.6 kg

Specifications subject to change without notice.