

KENWOOD

NEXEDGE NX-700/ NX-800

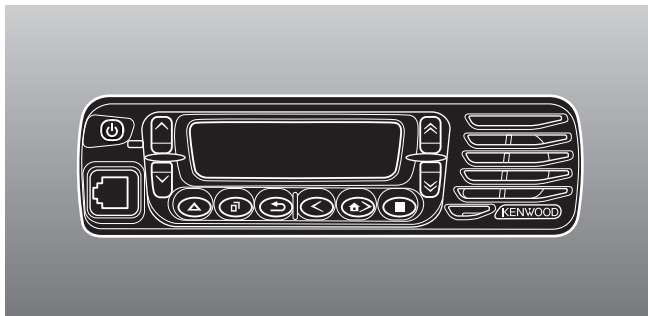

VHF DIGITAL TRANSCEIVER/
UHF DIGITAL TRANSCEIVER
INSTRUCTION MANUAL

ÉMETTEUR-RÉCEPTEUR NUMÉRIQUE VHF/
ÉMETTEUR-RÉCEPTEUR NUMÉRIQUE UHF
MODE D'EMPLOI

TRANSCPTOR DIGITAL VHF/
TRANSCPTOR DIGITAL UHF
MANUAL DE INSTRUCCIONES

RICETRASMETTITORE DIGITALE VHF/
RICETRASMETTITORE DIGITALE UHF
MANUALE DI ISTRUZIONI

VHF DIGITAL FUNKGERÄT/
UHF DIGITAL FUNKGERÄT
BEDIENUNGSANLEITUNG

VHF DIGITALE ZENDONTVANGER/
UHF DIGITALE ZENDONTVANGER
GEBRUIKSAANWIJZING

VHF SAYISAL ARAÇ TELSİZİ/
UHF SAYISAL ARAÇ TELSİZİ
KULLANIM KILAVUZU

ΨΗΦΙΑΚΟΣ ΠΟΜΠΟΔΕΚΤΗΣ VHF/
ΨΗΦΙΑΚΟΣ ΠΟΜΠΟΔΕΚΤΗΣ UHF
ΟΔΗΓΙΕΣ ΧΡΗΣΗΣ

Kenwood Corporation

© B62-2112-00 (E)
09 08 07 06 05 04 03 02 01 00

VHF DIGITAL TRANSCEIVER/
UHF DIGITAL TRANSCEIVER

NX-700/ NX-800

ENGLISH

INSTRUCTION MANUAL

Kenwood Corporation

NOTIFICATION

This equipment complies with the essential requirements of Directive 1999/5/EC.

The use of the warning symbol  means the equipment is subject to restrictions of use in certain countries.

This equipment requires a licence and is intended for use in the countries as below.

AT	BE	DK	FI	FR	DE	GR	IS
IE	IT	LI	LU	NL	NO	PT	ES
SE	CH	GB	CY	CZ	EE	HU	LV
LT	MT	PL	SK	SI	BG	RO	

ISO3166

**Information on Disposal of Old Electrical and Electronic Equipment and Batteries
(applicable for EU countries that have adopted separate waste collection systems)**



Products and batteries with the symbol (crossed-out wheeled bin) cannot be disposed as household waste.

Old electrical and electronic equipment and batteries should be recycled at a facility capable of handling these items and their waste byproducts.

Contact your local authority for details in locating a recycle facility nearest to you.



Proper recycling and waste disposal will help conserve resources whilst preventing detrimental effects on our health and the environment.

Notice: The sign "Pb" below the symbol for batteries indicates that this battery contains lead.

Pb

THANK YOU

We are grateful you have chosen **Kenwood** for your personal mobile applications.

This instruction manual covers only the basic operations of your NEXEDGE mobile radio. Ask your dealer for information on any customized features they may have added to your radio.

NXDN™

NXDN™ is a protocol name for the new digital communication system using 4-level FSK technology which has been co-developed by **Kenwood** and Icom.

NOTICES TO THE USER

- ◆ Government law prohibits the operation of unlicensed transmitters within the territories under government control.
- ◆ Illegal operation is punishable by fine and/or imprisonment.
- ◆ Refer service to qualified technicians only.

SAFETY: It is important that the operator is aware of, and understands, hazards common to the operation of any transceiver.



WARNING

- ◆ **EXPLOSIVE ATMOSPHERES (GASES, DUST, FUMES, etc.)**
Turn OFF your transceiver while taking on fuel or while parked in gasoline service stations. Do not carry spare fuel containers in the trunk of your vehicle if your transceiver is mounted in the trunk area.
- ◆ **INJURY FROM RADIO FREQUENCY TRANSMISSIONS**
Do not operate your transceiver when somebody is either standing near to or touching the antenna, to avoid the possibility of radio frequency burns or related physical injury.
- ◆ **DYNAMITE BLASTING CAPS**
Operating the transceiver within 500 feet (150 m) of dynamite blasting caps may cause them to explode. Turn OFF your transceiver when in an area where blasting is in progress, or where "TURN OFF TWO-WAY RADIO" signs have been posted. If you are transporting blasting caps in your vehicle, make sure they are carried in a closed metal box with a padded interior. Do not transmit while the caps are being placed into or removed from the container.

The AMBE+2™ voice coding Technology embodied in this product is protected by intellectual property rights including patent rights, copyrights and trade secrets of Digital Voice Systems, Inc. This voice coding Technology is licensed solely for use within this Communications Equipment. The user of this Technology is explicitly prohibited from attempting to extract, remove, decompile, reverse engineer, or disassemble the Object Code, or in any other way convert the Object Code into a human-readable form. U.S. Patent Nos. #5,870,405, #5,826,222, #5,754,974, #5,701,390, #5,715,365, #5,649,050, #5,630,011, #5,581,656, #5,517,511, #5,491,772, #5,247,579, #5,226,084 and #5,195,166.

PRECAUTIONS

Observe the following precautions to prevent fire, personal injury, and transceiver damage.

- Do not attempt to configure the transceiver while driving; it is too dangerous.
- Do not disassemble or modify the transceiver for any reason.
- Do not expose the transceiver to long periods of direct sunlight, nor place it near heating appliances.
- If an abnormal odor or smoke is detected coming from the transceiver, switch the transceiver power off immediately, and contact your **Kenwood** dealer.
- Use of the transceiver while you are driving may be against traffic laws. Please check and observe the vehicle regulations in your area.
- Do not use options not specified by **Kenwood**.



CAUTION

- ◆ The transceiver operates in **12 V** negative ground systems only! Check the battery polarity and voltage of the vehicle before installing the transceiver.
- ◆ Use only a **Kenwood** optional DC power cable.
- ◆ Do not cut and/or remove the fuse holder on the DC power cable.



WARNING

For passenger safety, install the transceiver securely using an optional mounting bracket and screw set so the transceiver will not break loose in the event of a collision.

CONTENTS

UNPACKING AND CHECKING EQUIPMENT	1
SUPPLIED ACCESSORIES	1
PREPARATION	2
TOOLS REQUIRED	2
POWER CABLE CONNECTION	2
INSTALLING THE TRANSCEIVER	3
GETTING ACQUAINTED.....	4
FRONT PANEL.....	4
DISPLAY.....	5
PROGRAMMABLE FUNCTIONS.....	6
BASIC OPERATIONS.....	7
SWITCHING POWER ON/OFF	7
ADJUSTING THE VOLUME.....	7
SELECTING A ZONE AND CHANNEL/GROUP ID.....	7
TRANSMITTING.....	7
RECEIVING.....	8
MENU MODE	9
MENU ACCESS.....	9
MENU CONFIGURATION	9
CHARACTER ENTRY	11
SCAN	12
TEMPORARY CHANNEL LOCKOUT.....	12
PRIORITY SCAN	12
SCAN REVERT.....	12
SCAN DELETE/ADD.....	13
PRIORITY-CHANNEL SELECT.....	13
FleetSync: ALPHANUMERIC 2-WAY PAGING FUNCTION.....	14
SELCALL (SELECTIVE CALLING).....	14
STATUS MESSAGE	14
SHORT/LONG MESSAGES.....	15
GPS REPORT.....	15

ADVANCED OPERATIONS	16
DTMF (DUAL TONE MULTI FREQUENCY) CALLS	16
TRUNKING CALLS (ANALOG)	16
EMERGENCY CALLS	17
SCRAMBLER.....	17
SIGNALING.....	18
CLOCK.....	19
LCD BRIGHTNESS.....	19
HORN ALERT	19
PUBLIC ADDRESS (PA).....	19
BACKGROUND OPERATIONS	20
TIME-OUT TIMER (TOT)	20
SIGNAL STRENGTH INDICATOR	20
COMPANDER	20
BUSY CHANNEL LOCKOUT (BCL).....	20
CONTROL CHANNEL HUNT	20
PTT ID	20
VGS-1 OPTIONAL VOICE GUIDE & STORAGE UNIT	21
VOICE RECORDER.....	21
VOICE GUIDE	22

UNPACKING AND CHECKING EQUIPMENT

Note: The following unpacking instructions are for use by your **Kenwood** dealer, an authorized **Kenwood** service facility, or the factory.

Carefully unpack the transceiver. We recommend that you identify the items listed in the following list before discarding the packing material. If any items are missing or have been damaged during shipment, file a claim with the carrier immediately.

SUPPLIED ACCESSORIES

• DC power cable	1
• Fuse (15 A)	2
• Mounting bracket	1
• Screw set	
• 5 x 16 mm self-tapping screw	4
• Hex-headed screw with washer	4
• Spring washer	4
• Flat washer	4
• Instruction manual	1

PREPARATION



WARNING

Various electronic equipment in your vehicle may malfunction if they are not properly protected from the radio frequency energy which is present while transmitting. Electronic fuel injection, anti-skid braking, and cruise control systems are typical examples of equipment that may malfunction. If your vehicle contains such equipment, consult the dealer for the make of vehicle and enlist his/her aid in determining if they will perform normally while transmitting.

Note: The following preparation instructions are for use by your **Kenwood** dealer, an authorized **Kenwood** service facility, or the factory.

TOOLS REQUIRED

Note: Before installing the transceiver, always check how far the mounting screws will extend below the mounting surface. When drilling mounting holes, be careful not to damage vehicle wiring or parts.

The following tools are required for installing the transceiver:

- 1/4 inch (6 mm) or larger electric drill
- 5/32 inch (4.2 mm) drill bit for the self-tapping screws used to mount the optional mounting bracket
- Circle cutters

POWER CABLE CONNECTION



CAUTION

- ◆ The transceiver operates in **12 V** negative ground systems only! Check the battery polarity and voltage of the vehicle before installing the transceiver.
- ◆ Use only a **Kenwood** optional DC power cable.
- ◆ Do not cut and/or remove the fuse holder on the DC power cable.

- 1 Check for an existing hole, conveniently located in the firewall, where a power cable can be passed through. If no hole exists, use a circle cutter to drill the firewall, then install a rubber grommet.
- 2 Run the two power cable leads through the firewall and into the engine compartment, from the passenger compartment.
- 3 Connect the red lead to the positive (+) battery terminal and the black lead to the negative (-) battery terminal.
 - Locate the fuse as close to the battery as possible.
- 4 Coil and secure the surplus cable with a retaining band.
 - Be sure to leave enough slack in the cables so the transceiver can be removed for servicing while keeping the power applied.

INSTALLING THE TRANSCEIVER



WARNING

For passenger safety, install the transceiver securely using an optional mounting bracket and screw set so the transceiver will not break loose in the event of a collision.

- 1 Mark the position of the holes in the dash by using the mounting bracket as a template. Drill the holes, then attach the mounting bracket using self-tapping screws.
 - Be sure to mount the transceiver in a location where the controls are within easy reach of the user and where there is sufficient space at the rear of the transceiver for cable connections.
- 2 Connect the antenna and power cable to the transceiver.
- 3 Slide the transceiver into the mounting bracket and secure it using hex-headed screws.
- 4 Mount an optional microphone hanger in a location where it will be within easy reach of the user.
 - The optional microphone and microphone cable should be mounted in a location where it will not interfere with the safe operation of the vehicle.



CAUTION

When replacing the fuse in the DC power cable, be sure to replace it with a fuse of the same value. Never replace a fuse with a fuse that has a higher value.

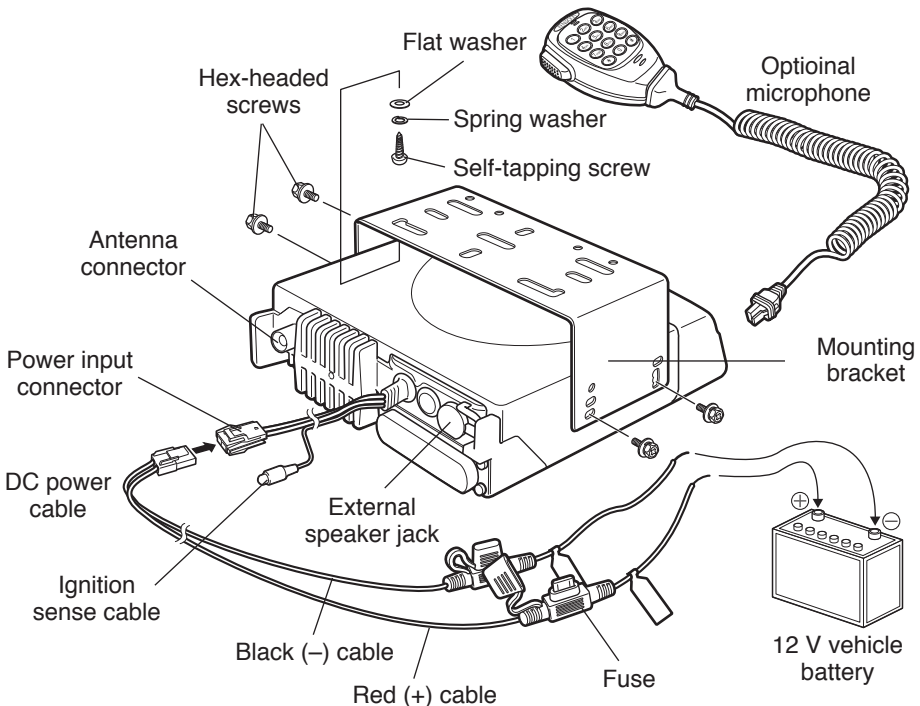

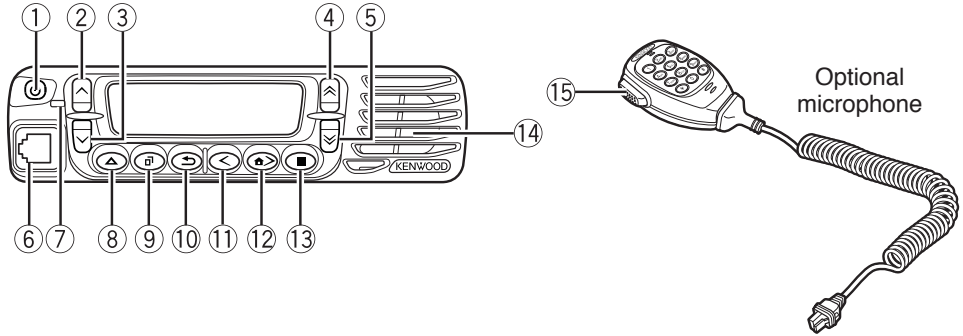

GETTING ACQUAINTED

FRONT PANEL









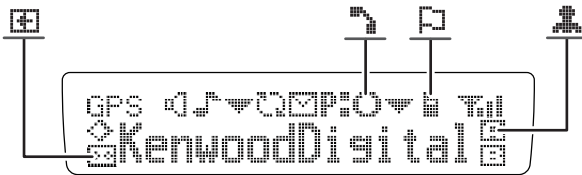









- ① **(power) switch**
Press and hold to switch the transceiver power ON and OFF.
- ② **▲ key**
Press to activate its programmable function {page 6}. The default is Volume Up.
- ③ **▼ key**
Press to activate its programmable function {page 6}. The default is Volume Down.
- ④ **▲ key**
Press to activate its programmable function {page 6}. The default is Channel/Group ID Up.
- ⑤ **▼ key**
Press to activate its programmable function {page 6}. The default is Channel/Group ID Down.
- ⑥ **Microphone jack**
Insert the microphone plug into this jack.
- ⑦ **LED indicator**
Lights red while transmitting and green while receiving a call.
- ⑧ **▲ key**
Press to activate its programmable function {page 6}.
- ⑨ **Ⓜ key**
Press to activate its programmable function {page 6}. The default is Menu.
- ⑩ **Ⓢ key**
Press to activate its programmable function {page 6}. The default is Squelch Off Momentary.
- ⑪ **◀ key**
Press to activate its programmable function {page 6}. The default is Zone Down.

- ⑫  **key**
Press to activate its programmable function {page 6}. The default is Zone Up.
- ⑬  **key**
Press to activate its programmable function {page 6}.
- ⑭ **Speaker**
Internal speaker
- ⑮ **PTT (Push-to-Talk) switch**
Press and hold this switch, then speak into the microphone to call a station.

DISPLAY



Indicator	Description
	Monitor or Squelch Off is activated.
	Blinks when an incoming call matches your Optional Signaling.
	The current zone (left icon) or CH/GID (right icon) is added to scan.
	Scan is in progress. Blinks while scan is paused.
	A message is stored in memory. Blinks when a new message has arrived.
	The current channel is a Priority channel.
	Operator Selectable Tone (OST) is activated.
	A Telephone ID call is being received. Blinks during Auto Telephone Search.
	Talk Around is activated.
	Site Lock is activated.
	Signal strength indicator {page 20}.
	Scrambler/ Encryption is activated.
	Auto Recording on the VGS-1 option is activated.
	Auto Reply Message is activated.
	The AUX A function is activated.
	Lone Worker is activated.
	The AUX B function is activated.

PROGRAMMABLE FUNCTIONS

Following is a list of available programmable functions. Contact your dealer for details on those functions which have been programmed on your transceiver.

- 2-tone ¹
- Auto Reply Message ²
- Auto Telephone ³
- Autodial ⁴
- Autodial Programming ⁴
- AUX A
- AUX B
- Broadcast ⁵
- Call 1 ~ 6
- CH/GID Down
- Channel Entry
- CH/GID Up
- CH/GID Recall
- Clock
- Clock Adjustment
- CW Message ⁶
- Direct CH/GID 1 ~ 5
- Direct CH/GID Select 1 ~ 5
- Display Format
- Emergency ⁷
- Fixed Volume
- Forced Search ⁵
- Function
- GPS Position Display
- Group (NXDN) ⁶
- Group + SDM (NXDN) ⁸
- Group + Status (NXDN) ⁸
- Home CH/GID
- Home CH/GID Select
- Horn Alert
- Individual (NXDN) ⁸
- Individual + SDM (NXDN) ⁸
- Individual + Status (NXDN) ⁸
- LCD Brightness
- Lone Worker
- Maintenance
- Menu
- Monitor ⁹
- Monitor Momentary ⁹
- OST (Operator Selectable Tone) ¹
- Playback ²
- Priority-channel Select ¹⁰
- Public Address
- Scan
- Scan Delete/Add
- Scrambler/Encryption
- Scrambler/Encryption Code ⁸
- SDM (FleetSync/ NXDN)
- Selcall (FleetSync) ⁴
- Selcall + SDM (FleetSync) ⁴
- Selcall + Status (FleetSync) ⁴
- Send the GPS data
- Site Down ⁵
- Site Lock ⁵
- Site Up ⁵
- Squelch Level ¹
- Squelch Off ¹
- Squelch Off Momentary ¹
- Stack
- Status (FleetSync/ NXDN)
- Talk Around ⁹
- Telephone Disconnect ³
- Transceiver Password
- Voice Memo ²
- Volume Down
- Volume Up
- Zone Delete/Add
- Zone Down
- Zone Up

¹ Available only for Analog Conventional operation

² Available only if the VGS-1 optional board has been installed.

³ Available only for Analog Trunking operation.

⁴ Available only for Analog Conventional and Analog Trunking operation.

⁵ Available only for NXDN Trunking operation.

⁶ Available only for NXDN Conventional operation.

⁷ Emergency can be programmed only on the  key and an optional auxiliary switch, such as an emergency foot switch.



⁸ Available only for NXDN Conventional and NXDN Trunking operation.

⁹ Available only for Analog Conventional, Analog Trunking, and NXDN Conventional operation.

¹⁰ Available only for Analog Conventional and NXDN Conventional operation.



BASIC OPERATIONS

SWITCHING POWER ON/OFF





Press and hold the  switch for approximately 1 second to turn the transceiver power ON. Press and hold the  switch again to turn the transceiver OFF.

■ Transceiver Password

If the transceiver is password protected, "PASSWORD" will appear on the display when the power is turned ON. To unlock the transceiver, enter the password:

- 1 Select a character using /.



 - If you are using a microphone keypad, you can enter the password directly.

- 2 Press  to enter the selected character.
 - This step is unnecessary when using the keypad.
- 3 Repeat steps 1 and 2 to enter the entire password.
 - Press  or # to delete a character. Press and hold  or # to delete all characters.
- 4 Press  or * to confirm the entry.
 - If you enter an incorrect password, an error tone sounds and the transceiver remains locked.
 - The password can contain a maximum of 6 digits.

ADJUSTING THE VOLUME

Press the keys programmed as **Volume Up/ Volume Down** to adjust the volume.

SELECTING A ZONE AND CHANNEL/GROUP ID

Select the desired zone using / (default). Each zone contains a group of channels.

Select the desired channel/group ID using / (default). Each channel/group ID is programmed with settings for transmitting and receiving.

- You can toggle the display between the zone and channel/group ID names and number by pressing the key programmed as Display Format, or by accessing the Menu {page 9}.

Note: If the default settings for / and / have been changed, use the appropriate keys to select the zone and channel/group ID.



TRANSMITTING

- 1 Select the desired zone and channel/group ID.
- 2 Press the key programmed as **Monitor** or **Squelch Off** to check whether or not the channel is free.
 - If the channel is busy, wait until it becomes free.

- 3 Press the **PTT** switch and speak into the microphone. Release the **PTT** switch to receive.
 - For best sound quality, hold the microphone approximately 1.5 inches (3 ~ 4 cm) from your mouth.



■ Making Group Calls (Digital)

If a key has been programmed with **Group** or **Group + Status**, you can select a group ID from the list to make a call to those parties. To select a group ID:

- 1 Press the key programmed as **Group** or **Group + Status**.
- 2 Press   to select a group ID/name from the list.
- 3 Press and hold the **PTT** switch to make the call.
 - Speak into the microphone as you would during a normal transmission.

■ Making Individual Calls (Digital)

If a key has been programmed with **Individual** or **Individual + Status**, you can make calls to specific persons.

- 1 Press the key programmed as **Individual** or **Individual + Status**.
- 2 Press the   keys to select a unit ID from the list.
 - If you are using a microphone keypad, you can enter a unit ID directly.
- 3 Press and hold the **PTT** switch to make the call.
 - Speak into the microphone as you would during a normal transmission.

RECEIVING

Select the desired zone and channel. If signaling has been programmed on the selected channel, you will hear a call only if the received signal matches your transceiver settings.

Note: Signaling allows your transceiver to code your calls. This will prevent you from listening to unwanted calls. Refer to "SIGNALING" on page 18 for details.

■ Receiving Group Calls (Digital)

When you receive a group call on a Conventional channel and the received group ID matches the ID set up on your transceiver, you can hear the caller's voice.

When you receive a group call on a Trunking channel, the transceiver automatically switches to the communications channel to receive the call.









■ Receiving Individual Calls (Digital)

When you receive an individual call on a Conventional channel, a ringing tone will sound and the caller's ID will appear on the display. To respond to the call, press and hold the **PTT** switch and speak into the microphone as you would during a normal transmission.

MENU MODE

Many functions on this transceiver are selected or configured through the Menu instead of physical controls. Once you become familiar with the Menu system, you will appreciate the versatility it offers.

MENU ACCESS

- 1 Press the key programmed as **Menu**.
- 2 Press / to select a Menu item.
 - If you are using a microphone keypad, you can enter a Menu number directly.
- 3 Press  to set up the selected Menu item.
- 4 Press / to select your desired setting.
 - For settings with more than 1 level, repeat steps 3 and 4.
- 5 Press  to set the selected setting and exit Menu mode.
 - Press  at any time to return to the previous display.
 - Press  at any time to exit Menu mode.

MENU CONFIGURATION

Some transceiver keys may already be programmed with functions listed in the Menu. Those functions can be accessed directly by pressing the key. All other functions can still be accessed using the transceiver Menu. The following table lists the available Menu items.

No.	Menu	Description
01	2-TONE	2-tone Mode
02	AUTO REPLY MSG	Auto Reply Message ON/OFF
03	AUTO TELEPHONE	Auto Telephone
04	AUTO DIAL	Autodial Mode
05	AUTO DIAL PROG	Autodial Programming Mode
06	AUX A	AUX A ON/OFF
07	AUX B	AUX B ON/OFF
08	BROADCAST	Broadcast ON/OFF
09	CLOCK	Clock ON/OFF
10	CLOCK ADJUST	Clock Adjustment mode
11	DIRECT CH1 SEL	Direct CH/GID 1 ~ 5 Select
12	DISP FORMAT	Display Format ON/OFF
13	FIXED VOLUME	Fixed Volume
14	FORCED SEARCH	Forced Search



No.	Menu	Description
15	GPS POS DISP	GPS Position Display mode
16	GROUP	Group mode
17	GROUP+STATUS	Group + Status mode
18	GROUP+SDM	Group + SDM mode
19	HOME CH SEL	Home CH/GID Select
20	HORN ALERT	Horn Alert ON/OFF
21	INDIVIDUAL	Individual mode
22	INDIV+STATUS	Individual + Status mode
23	INDIV+SDM	Individual + SDM mode
24	LCD BRIGHTNESS	LCD Brightness level
25	MONITOR	Monitor ON/OFF
26	OST	OST ON/OFF
27	OST LIST	OST mode
28	PLAYBACK	Playback mode
29	PRI CH SEL	Priority Channel Select mode
30	PUBLIC ADDRESS	Public Address System ON/OFF
31	SCAN	Scan ON/OFF
32	SCAN DEL/ADD	Scan Delete/Add
33	SCRAM/ENCRYP	Scrambler/Encryption ON/OFF
34	SCRAM CODE	Scrambler/Encryption Code mode
35	SELCALL	Selcall mode
36	SELCALL+STATUS	Selcall + Status mode
37	SELCALL+SDM	Selcall + SDM mode
38	SEND GPS DATA	Transmit your GPS data
39	SITE LOCK	Site Lock ON/OFF
40	SITE No.	Display Site Number
41	SQUELCH LEVEL	Squelch Level mode
42	SQUELCH OFF	Squelch Off ON/OFF
43	STACK	Stack mode
44	STATUS	Status mode
45	SHORT MESSAGE	Short Message mode
46	TALK AROUND	Talk Around ON/OFF
47	PASSWORD	Transceiver Password mode

No.	Menu	Description
48	VOICE MEMO	Voice Memo mode
49	ZONE DEL/ADD	Zone Delete/Add

CHARACTER ENTRY

There are 2 methods available for entering characters:

1) Pressing the   keys

Press   to cycle the characters from A ~ Z, 0 ~ 9, and a space (default settings).

You can also assign a character to an optional key and later press that key to recall the assigned character: A ~ Z, a ~ z, 0 ~ 9, or a space and characters.

2) Using the microphone keypad

Press the microphone keys to enter characters as shown in the table below:

DTMF Key	Character Cycle
1	1
2	A B C 2
3	D E F 3
4	G H I 4
5	J K L 5
6	M N O 6
7	P Q R S 7
8	T U V 8
9	W X Y Z 9
0	[space] 0

SCAN

Scan monitors for signals on the transceiver channels. While scanning, the transceiver checks for a signal on each channel and only stops if a signal is present.

To begin scanning, press the key programmed as **Scan**.

- The  icon appears on the display.
- When a signal is detected on a channel, Scan pauses at that channel. The transceiver will remain on the busy channel until the signal is no longer present, at which time Scan resumes.

To stop scanning, press the **Scan** key again.

Note: To use Scan, there must be at least 2 channels in the scan sequence.

TEMPORARY CHANNEL LOCKOUT

During scan, you can temporarily remove specific channels from the scanning sequence by selecting them and pressing the key programmed as **Scan Delete/Add**.

- The channel is no longer scanned. However, when scanning is ended and restarted, the channels are reset and deleted channels will again be in the scanning sequence.

PRIORITY SCAN

Note: To use Priority Scan, a Priority channel must be programmed.

When using a single Priority channel, the transceiver will automatically change to the Priority channel when a call is received on that channel, even if a call is being received on a normal channel.

When using dual Priority channels, Priority channel 1 is given precedence over Priority channel 2. So, if a call is received on Priority channel 1 while a call is already on Priority channel 2, the transceiver will change to Priority channel 1.

SCAN REVERT

The Scan Revert channel is the channel selected when you press the **PTT** switch to transmit during scan. Your dealer can program one of the following Scan Revert channels:

- **Selected:** The last channel selected before scan.
- **Selected + Talkback:** Same as “Selected”, plus you can respond to calls on the channel at which scan is paused.
- **Priority 1/ Priority 2:** The Priority channel (either Priority 1 or Priority 2).
- **Priority 1 + Talkback/ Priority2 + Talkback:** Same as “Priority 1/ Priority 2”, plus you can respond to calls on the channel at which scan is paused.
- **Last Called + Selected:** The last channel on which you receive a call.







SCAN DELETE/ADD

You can add and remove zones and/or channels/group IDs to and from your scan list.

- 1 Select your desired zone and/or channel/group ID.
- 2 Press the key programmed as **Zone Delete/Add** (to add/remove zones) or **Scan Delete/Add** (to add/remove channels/group IDs).
 - You can also press and hold the key programmed as **Scan Delete/Add** to add/remove zones.

PRIORITY-CHANNEL SELECT

If the Priority channel has been set as Operator Selectable by your dealer, you can reprogram the Priority channels.

- 1 Select your desired zone and channel/group ID.
- 2 Press the key programmed as **Priority-channel Select**.
- 3 Press / to select "NORMAL", "PRIORITY 1" (), "PRIORITY 2" (), or "PRIORITY 1&2" ().
- 4 Press  to save the setting and exit.

FleetSync: ALPHANUMERIC 2-WAY PAGING FUNCTION



FleetSync is an Alphanumeric 2-way Paging Function, and is a protocol owned by **Kenwood** Corporation.

Note: This function is available only in analog operation.

SELCALL (SELECTIVE CALLING)

A Selcall is a voice call to a station or group of stations.

■ Transmitting

- 1 Select your desired zone and channel.
- 2 Press the key programmed as **Selcall** or **Selcall + Status** to enter Selcall mode.
- 3 Press   to select the station you want to call.
 - If you are using a microphone keypad and Manual Dialing is enabled, you can directly enter the station ID.
- 4 Press the **PTT** switch and begin your conversation.

■ Receiving

An alert tone will sound and the transceiver will enter Selcall Mode. The calling station's ID will appear when a Selcall is received. You can respond to the call by pressing the **PTT** switch and speaking into the microphone.

■ Identification Codes

An ID code is a combination of a 3-digit Fleet number and a 4-digit ID number. Each transceiver has its own ID.

- Enter a Fleet number (100 ~ 349) to make a group call.
- Enter an ID number (1000 ~ 4999) to make an individual call in your fleet.
- Enter a Fleet number to make a call to all units in the selected fleet (Fleet call).
- Enter an ID number to make a call to the selected ID in all fleets (Supervisor call).
- Select "ALL" Fleet and "ALL" ID to make a call to all units (Broadcast call).

STATUS MESSAGE

You can send and receive 2-digit Status messages which may be decided in your talk group. Messages can contain up to 16 alphanumeric characters. Status messages range from 10 to 99 (80 ~ 99 are reserved for special messages).

A maximum of 15 received messages (combined status messages and short messages) can be stored in the stack memory of your transceiver.

■ Transmitting

- 1 Select your desired zone and channel.
- 2 Press the key programmed as **Status** to enter Status mode (proceed to step 5) or **Selcall + Status** to enter Selcall mode (proceed to step 3).

- 3 Press to select the station you want to call.
 - If Manual Dialing is enabled, you can enter the station ID by using the microphone keypad, or by using . When using , cycle through the digits to select a digit, then press to set the digit and move the cursor to the right. Repeat this process until the entire ID is entered.
- 4 Press to enter Status mode.
- 5 Press to select the status you want to transmit.
 - If Manual Dialing is enabled, you can enter the status ID by using the microphone keypad, or by using (refer to step 3, above).
- 6 Press the **PTT** switch or to initiate the call.
 - “<<COMPLETE>>” appears on the display when the status has been successfully transmitted.

■ Receiving

The icon will flash and a calling ID or text message will appear when a Status call is received. Press any key to return to normal operation.

■ Reviewing Messages in the Stack Memory

- 1 Press the key programmed as **Stack**, or press and hold the key programmed as **Selcall**, **Status**, or **Selcall + Status** to enter Stack mode.
 - The last received message is displayed.
- 2 Press to select the desired message.
 - Message types are identified as follows:
I: Caller ID, S: Status Message, M: Short Message
 - Press and hold for 1 second to cycle the display information as follows:
ID Name > Status/Short Message > CH/GID > Time Stamp
- 3 Press to return to normal operation.
 - To delete the selected message, press or #. To confirm the deletion, press or *.
 - To delete all messages, press and hold or # for 1 second. To confirm the deletion, press or *.

SHORT/LONG MESSAGES

Received short messages are displayed the same as Status messages and are stored in the same stack memory.

To send short messages, and to send and receive long messages, you must connect the transceiver to a PC. Ask your dealer for details.

GPS REPORT

To send your location data, you must first connect a GPS unit to the transceiver. GPS data can be manually transmitted by pressing the key programmed as **Send the GPS data**, or by accessing the Menu {page 9}. If set up by your dealer, GPS data may be automatically transmitted at a preset time interval.

DTMF (DUAL TONE MULTI FREQUENCY) CALLS



■ Making a DTMF Call

Note: DTMF calls can be made only in analog operation.

Manual Dialing (Microphone Keypad Only)



- 1 Press and hold the **PTT** switch.
- 2 Enter the desired digits using the microphone keypad.
 - If you release the **PTT** switch, transmit mode will end even if the complete number has not been sent.
 - If the Keypad Auto PTT function has been enabled by your dealer, you do not need to press the **PTT** switch to transmit; you can make the call simply by pressing the microphone keys.

Store & Send

- 1 Press the key programmed as **Autodial**.
- 2 Enter up to 30 digits using the microphone keypad.
 - Alternatively, you can enter digits by using   {page 11}.
- 3 Press the **PTT** switch or  to make the call.

■ Autodial

Autodial allows you to quickly call DTMF numbers that have been programmed onto your transceiver.

- 1 Press the key programmed as **Autodial**, or access the Menu {page 9).
 - The first entry in the Autodial list appears on the display.
- 2 Press   to select your desired Autodial list number, or enter the list number directly (01 ~ 32) .
 - The stored entry appears on the display.
- 3 Press the **PTT** switch to make the call.

■ Stun Code

This function is used when a transceiver is stolen or lost. When the transceiver receives a call containing a stun code, the transceiver becomes disabled. The stun code is cancelled when the transceiver receives a call with a revive code.



TRUNKING CALLS (ANALOG)

■ Making a Telephone Call

Manual Dialing

- 1 Select your desired zone and telephone group ID.
- 2 Press the **PTT** switch to start the call.
- 3 Enter your desired number using the microphone keys.

Selecting a Number from the List

- 1 Select your desired zone and telephone group ID.
- 2 Press the key programmed as **Autodial**.
 - The last called unit appears on the display.
- 3 Press   to select your desired list number.
- 4 Press the **PTT** switch to start the call.

■ Receiving a Telephone Call

When a call is received, press and hold the **PTT** switch to speak, and release it to receive.

- Only one person can speak at a time.

EMERGENCY CALLS

If your transceiver has been programmed with the Emergency function, you can make emergency calls.

- 1 Press and hold the key programmed as **Emergency**.
 - Ask your dealer for the length of time necessary to hold this key before the transceiver enters Emergency mode.
 - When the transceiver enters Emergency mode, it will change to the Emergency channel and begin transmitting based on how it is set up by your dealer.
- 2 To exit Emergency mode, press and hold the **Emergency** key again.
 - If the Emergency mode completes a preset number of cycles, Emergency mode will automatically end and the transceiver will return to the zone and channel that was in use before Emergency mode was entered.

Note:

- ◆ Your dealer can set the transceiver to emit a tone when transmitting in Emergency mode.
 - ◆ Your dealer can set the transceiver to emit tones and received signals as normal, or mute the speaker during Emergency operation.
-

SCRAMBLER

Press the key programmed as **Scrambler/ Encryption**, or access the Menu {page 9}, to switch the transceiver to secure (encrypted) transmission.

- Pressing the microphone **PTT** switch after the Scrambler function has been turned ON encrypts the transmitted signal.



SIGNALING

■ Quiet Talk (QT)/ Digital Quiet Talk (DQT)

Your dealer may have programmed QT or DQT signaling on your transceiver channels. A QT tone/ DQT code is a sub-audible tone/code which allows you to ignore (not hear) calls from other parties who are using the same channel.

Operator Selectable Tone (OST)

If a key has been programmed with **OST**, you can reprogram the QT/DQT settings on each of your channels.

- 1 Select your desired channel.
- 2 Press and hold the key programmed as **OST** for 1 second.
- 3 Press   to select your desired tone or code.
 - Your dealer can set up to 40 tones/codes.
- 4 Press  to save your new setting.
- 5 When you have finished operating using OST, press the **OST** key again to turn the OST function OFF.

■ Radio Access Number (RAN)

RAN is a new signaling system designed for digital radio communications.

When a channel is set up with a RAN, squelch will only open when a call containing a matching RAN is received. If a call containing a different RAN is made on the same channel you are using, you will not hear the call. This allows you to ignore (not hear) calls from other parties who are using the same channel.

■ Optional Signaling

Your dealer may also program several types of option signaling for your transceiver channels.

2-tone Signaling: 2-tone Signaling opens the squelch only when your transceiver receives a call containing matching 2 tones.

DTMF Signaling: DTMF Signaling opens the squelch only when the transceiver receives a call containing a matching DTMF code.

FleetSync Signaling: Refer to “SELCALL (SELECTIVE CALLING)” on page 14.





NXDN ID Signaling: NXDN ID is an optional signaling system available only for digital communications.

CLOCK

If activated by your dealer, you can view the clock any time by pressing the key programmed as **Clock**.

Note: Removing the transceiver power for extended periods will clear the clock time.

To set the time:

- 1 Press the key programmed as **Clock Adjustment**.
 - The current time setting appears.
- 2 Press / to increase or decrease the year setting.
- 3 Press  to set the year and cycle to the month setting.
- 4 Repeat steps 2 and 3 to set the month, day, hour, and minute.
- 5 Press  to exit Clock Adjustment mode.
 - You can press  at any time to exit Clock Adjustment mode.

LCD BRIGHTNESS

The LCD backlight can be turned off or set to low or high levels. To cycle through the brightness settings, press the key programmed as **LCD Brightness**.

- Each press of **LCD Brightness** cycles the brightness level from high to low to off, and then back to high.

HORN ALERT

To use the Horn Alert function, your dealer must install an optional unit. When a call is received that matches the optional signaling set up on your transceiver, Horn Alert causes the vehicle horn or some other external alert to sound. This function notifies you of a received call when you are away from your vehicle.

To toggle Horn Alert ON and OFF, press the key programmed as **Horn Alert** or access the Menu {page 9}.

- HA momentarily appears on the display when Horn Alert is active.

PUBLIC ADDRESS (PA)

To use the Public Address system, your dealer must install an optional unit and an external speaker. This function causes all audio input via the microphone to be amplified and output through the external speaker.

To use the PA system:

- 1 Press the key programmed as **Public Address** or access the Menu {page 9}.
 - PA appears on the display when the PA system is active.
- 2 Press and hold the **PTT** switch, then speak into the microphone.
 - Use the **Volume Up** and **Volume Down** keys to adjust the audio output from the external speaker.
- 3 Press the **Public Address** key again or change the zone or channel/group ID to return to normal operation.

BACKGROUND OPERATIONS

Your dealer can activate a variety of transceiver functions to perform without any additional operation on your part.

TIME-OUT TIMER (TOT)

The Time-out Timer is used to prevent you from using a channel for an extended duration. If you continuously transmit for a preset time, the transceiver will stop transmitting and an alert tone will sound. Release the microphone **PTT** switch.

SIGNAL STRENGTH INDICATOR

The signal strength indicator displays the strength of received calls.



No icon appears when no signal is available.

 flashes when out of range (NXDN Trunking only).

COMPANDER

If programmed by your dealer for a channel, the compander will remove excessive noise from transmitted signals, to provide higher clarity of signals.

BUSY CHANNEL LOCKOUT (BCL)

On Conventional channels, if BCL is set up by your dealer, you will be unable to transmit if the channel is already in use. Use a different channel or wait until the channel becomes free.

If BCL Override has been programmed, you can transmit over the current signal:

- 1 Press and hold the **PTT** switch.
 - If the channel is already in use, a warning tone will sound.
- 2 Quickly release and then press the **PTT** switch again.
- 3 Speak into the microphone as you would during a normal call.

CONTROL CHANNEL HUNT

On digital Trunking channels, the transceiver automatically searches for a control channel.

- While searching for a control channel, the antenna icon will flash and no signals can be received.

PTT ID

PTT ID is the transceiver unique ID code which is sent each time the **PTT** switch is pressed and/or released.

Note: PTT ID can be made only in analog operation.

VOICE RECORDER

The voice recorder allows you to record conversations and create voice memos.

■ Auto Recording

If activated, the auto recorder will continuously record all transmitted and received signals. The recording storage area retains only the last 30 seconds of recording.

■ Voice Memos

To record a voice memo for later playback:

- 1 Press the key programmed as **Voice Memo**, press and hold the key programmed as **Playback**, or access the Menu {page 9}.
 - The duration of recording memory will appear on the display and begin counting down.
- 2 Speak into the microphone to record your memo.
- 3 Press **Ⓜ** to end the recording and store it in memory.
 - If the memory becomes full, recording will stop and the voice memo will be stored in memory.





■ Auto Reply Message

You can set the transceiver to automatically respond to Individual Calls while using FleetSync/NXDN.

- 1 Press the key programmed as **Auto Reply Message** to enter Auto Reply Message mode.
- 2 When you receive an Individual Call, the transceiver will send an automatic response to the caller after 3 seconds, and "GREETING" appears on the display.
 - If you are available to receive the call, press any key to cancel the auto response.
 - If there is memory available on your transceiver for recording, "I am not available. Leave your Message." will be sent to the caller and they can leave a recorded message. When a message is stored on your transceiver, "Msg Rcvd" appears on the display.
 - If no memory is available on your transceiver, "I am not available" will be sent to the caller and "MEMORY FULL" appears on the display.

■ Playback

To play back a recorded conversation, memo, or message:

- 1 Press the key programmed as **Playback** or access the Menu {page 9}.
 - If the last action on your transceiver was to auto record your conversation, “STORE?” will appear on the display, otherwise a recording channel with the time of the recording will appear.
- 2 Press   to select the channel you want to play.
 - “AR” represents auto recorded conversations, “RM” represents auto reply messages, and “VM” represents voice memos.
- 3 The transceiver will announce the time and channel, then the recording will play back.
 - When the entire recording has been played, “END OF MESSAGE” is displayed. You can also end the recording at any time by pressing .
 - To delete the selected recording, press . To clear all the recorded data, press and hold .

VOICE GUIDE

When changing the zone and/or channel, an audio voice will announce the new zone and channel. Additionally, when changing a function setting, the new setting will be announced.

Note: Voice announcements vary by dealer setting.

KENWOOD

CE 0168 