

KENWOOD

AUDIO-VIDEO CONTROL CENTER

KRF-V6400D KRF-V5450D

INSTRUCTION MANUAL

Kenwood Corporation



**Declaration of Conformity with regard to
the EMC Directive 2004/108/EC**

Manufacturer:

Kenwood Corporation
2967-3 Ishikawa-machi, Hachioji-shi, Tokyo, 192-8525 Japan

EU Representative's:

Kenwood Electronics Europe BV
Amsterdamseweg 37, 1422 AC UITHOORN, The Netherlands



HDMI



RDS

© B60-5810-08/00 (E/X)

Safety precautions

⚠ Caution : Read this page carefully to ensure safe operation.





Units are designed for operation as follows.

Australia.....AC 240 V only
 Europe.....AC 230 V only



Before use

WARNING :

TO PREVENT FIRE OR ELECTRIC SHOCK, DO NOT EXPOSE THIS APPLIANCE TO RAIN OR MOISTURE.

	CAUTION RISK OF ELECTRIC SHOCK DO NOT OPEN	
CAUTION: TO REDUCE THE RISK OF ELECTRIC SHOCK, DO NOT REMOVE COVER (OR BACK). NO USER-SERVICEABLE PARTS INSIDE. REFER SERVICING TO QUALIFIED SERVICE PERSONNEL.		
	THE LIGHTNING FLASH WITH ARROWHEAD SYMBOL, WITHIN AN EQUILATERAL TRIANGLE, IS INTENDED TO ALERT THE USER TO THE PRESENCE OF UNINSULATED "DANGEROUS VOLTAGE" WITHIN THE PRODUCT'S ENCLOSURE THAT MAY BE OF SUFFICIENT MAGNITUDE TO CONSTITUTE A RISK OF ELECTRIC SHOCK TO PERSONS.	
	THE EXCLAMATION POINT WITHIN AN EQUILATERAL TRIANGLE IS INTENDED TO ALERT THE USER TO THE PRESENCE OF IMPORTANT OPERATING AND MAINTENANCE (SERVICING) INSTRUCTIONS IN THE LITERATURE ACCOMPANYING THE APPLIANCE.	

Information on Disposal of Old Electrical and Electronic Equipment and Batteries (applicable for EU countries that have adopted separate waste collection systems)

	Products and batteries with the symbol (crossed-out wheeled bin) cannot be disposed as household waste.
	Old electrical and electronic equipment and batteries should be recycled at a facility capable of handling these items and their waste byproducts.
	Contact your local authority for details in locating a recycle facility nearest to you.
Pb	Proper recycling and waste disposal will help conserve resources whilst preventing detrimental effects on our health and the environment.
	Notice: The sign "Pb" below the symbol for batteries indicates that this battery contains lead.

Unpacking

Unpack the unit carefully and make sure that all the accessories are present.

FM indoor antenna (1)

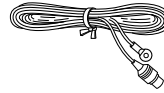

AM loop antenna (1)

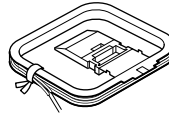

Remote control unit (1) RC-R0518

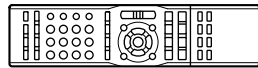

Batteries* (R03) (2)

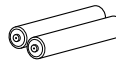

* Batteries are attached to the packing material.

If any accessories are missing, or if the unit is damaged or fails to operate, notify your dealer immediately. If the unit was shipped to you directly, notify your shipper immediately. Kenwood recommends that you retain the original carton and packing materials in case you need to move or ship the unit in the future.

Keep this manual handy for future reference.

Maintenance of the unit

When the front panel or case becomes dirty, wipe with a soft, dry cloth. Do not use thinner, benzine, alcohol, etc. for these agents may cause discoloration.

In regard to contact cleaner

Do not use contact cleaners because it could cause a malfunction. Be specially careful not to use contact cleaners containing oil, for they may deform the plastic component.

IMPORTANT SAFETY INSTRUCTIONS

⚠ Caution :Read this page carefully to ensure safe operation.

Read Instructions – All the safety and operating instructions should be read before the product is operated.

Retain Instructions – The safety and operating instructions should be retained for future reference.

Heed Warnings – All warnings on the product and in the operating instructions should be adhered to.

Follow Instructions – All operating and use instructions should be followed.

1. Cleaning – Unplug this product from the wall outlet before cleaning. Do not use liquid cleaners or aerosol cleaners. Use a damp cloth for cleaning.

2. Attachments – Do not use attachments not recommended by the product manufacturer as they may cause hazards.

3. Water and Moisture – This product shall not be exposed to dripping and splashing – for example, near a bath tub, wash bowl, kitchen sink, or laundry tub; in a wet basement; or near a swimming pool; and the like. Do not place an object containing liquid, such as a flower vase, on the appliance.

4. Accessories – Do not place this product on an unstable cart, stand, tripod, bracket, or table. The product may fall, causing serious injury to a child or adult, and serious damage to the product. Use only with a cart, stand, tripod, bracket, or table recommended by the manufacturer. Any mounting of the product should follow the manufacturer's instructions, and should use a mounting accessory recommended by the manufacturer. A product and cart combination should be moved with care. Quick stops, excessive force, and uneven surfaces may cause the product and cart combination to overturn.



5. Ventilation – Slots and openings in the cabinet are provided for ventilation and to ensure reliable operation of the product and to protect it from overheating, and these openings must not be blocked or covered. The openings should never be blocked by placing the product on a bed, sofa, rug, or other similar surface. This product should not be placed in a built-in installation such as a bookcase or rack unless proper ventilation is provided or the manufacturer's instructions have been adhered to.

6. Power Sources – This product should be operated only from the type of power source indicated on the product. If you are not sure of the type of power supply to your home, consult your product dealer or local power company.

7. CAUTION – Polarization – This product may be equipped with a polarized alternating-current line plug (a plug having one blade wider than the other). This plug will fit into the power outlet only one way. This is a safety feature. If you are unable to insert the plug fully into the outlet, try reversing the plug. If the plug should still fail to fit, contact your electrician to replace your obsolete outlet. Do not defeat the safety purpose of the polarized plug.

8. Power Cord Protection – Power-supply cords should be routed so that they are not likely to be walked on or pinched by items placed upon or against them, paying particular attention to cords at plugs, convenience receptacles, and the point where they exit from the product.

9. Lightning – For added protection for this product during a lightning storm, or when it is left unattended and unused for long periods of time, unplug it from the wall outlet and disconnect the antenna or cable system. This will prevent damage to the product due to lightning and power-line surges.

10. Overloading – Do not overload wall outlets, extension cords, or integral convenience receptacles as this can result in a risk of fire or electric shock.

11. Object and Liquid Entry – Never push objects of any kind into this product through openings as they may touch dangerous voltage points or short-out parts that could result in a fire or electric shock. Never spill liquid of any kind on the product.

12. Servicing – Do not attempt to service this product yourself as opening or removing covers may expose you to dangerous voltage or other hazards. Refer all servicing to qualified service personnel.

13. Damage Requiring Service – Unplug this product from the wall outlet and refer servicing to qualified service personnel under the following conditions:

- a) When the power-supply cord or plug is damaged,
- b) If liquid has been spilled, or objects have fallen into the product,
- c) If the product has been exposed to rain or water,
- d) If the product does not operate normally by following the operating instructions.
- e) If the product has been dropped or damaged in any way, and
- f) When the product exhibits a distinct change in performance – this indicates a need for service.
- g) If an abnormal smell or smoke is detected.

14. Replacement Parts – When replacement parts are required, be sure the service technician has used replacement parts specified by the manufacturer or have the same characteristics as the original part. Unauthorized substitutions may result in fire, electric shock, or other hazards.

15. Safety Check – Upon completion of any service or repairs to this product, ask the service technician to perform safety checks to determine that the product is in proper operating condition.

16. Wall or Ceiling Mounting – This product should be mounted to a wall or ceiling only as recommended by the manufacturer.

17. Heat – This product should be situated away from heat sources such as radiators, heat registers, stoves, or other products that produce heat. Do not place a flaming object, such as a candle or lantern, or near the product.

18. Power Lines – An outside antenna system should not be located in the vicinity of overhead power lines or other electric light or power circuits, or where it can fall into such power lines or circuits. When installing an outside antenna system, extreme care should be taken to keep from touching such power lines or circuits as contact with them might be fatal.

19. Outdoor Antenna Grounding – If an outside antenna or cable system is connected to the product, be sure the antenna or cable system is grounded so as to provide some protection against voltage surges and built-up static charges. Article 810 of the National Electrical Code, ANSI/NFPA 70, provides information with regard to proper grounding of the mast and supporting structure, grounding of the lead-in wire to an antenna discharge unit, size of grounding conductors, location of antenna-discharge unit, connection to grounding electrodes, and requirements for the grounding electrode.

Before use

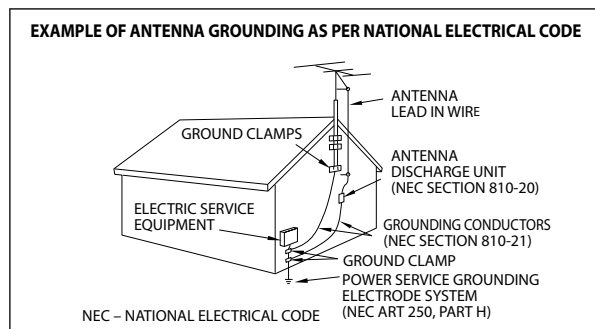

Notes:

- 1. Item 7 is not required except for grounded or polarized equipment.
- 2. Item 19 complies with UL in the U.S.A.

Contents

⚠ To ensure safety, read the items carrying this marking carefully.

Before use

Before use

- ⚠ Safety precautions** 2
- Unpacking 2
- ⚠ IMPORTANT SAFETY INSTRUCTIONS** 3
- Contents..... 4
- Special Features 5
- How to read this manual..... 6
- Names and functions of parts 7

Connections

- Notes on connections 11
- Speaker placement 11
- Connecting components equipped with HDMI terminals 12
- Connecting a TV Monitor..... 13
- Connecting a CD player 14
- Connecting a DVD player 15
- Connecting a video player..... 16
- Connecting an audio player 17
- Connecting to the [AV AUX] jacks 17
- Connecting speakers 18
- Connecting antennas..... 20
- Turning this unit ON..... 21

Setup

- Speaker setup (Easy Setup)** 22
- Speaker setup (Detailed Setup)** 23
 - Speaker setup flow
 - Speaker configuration
 - Speaker Level
 - Speaker Distance
 - Crossover
 - LFE (Low Frequency Effect) Level
 - Lip Sync (KRF-V6400D only)
- HDMI setup** 26
 - HDMI setup flow
 - Audio Out
 - Lip Sync (KRF-V6400D only)
 - HDMI Link
 - Power Control

Playing music or movie

- Preparation for playing music or movie**..... 28
 - Turning on the power
 - Setting the speaker system
 - Selecting the input mode
- Playback**..... 29
- Monitoring the input source in the original sound (STRAIGHT DECODE mode)**..... 29
- Listening to music with PURE AUDIO MODE**..... 30

Surround effects

- Listen mode** 31
 - About indicators
- Surround play using the listen mode** 32
- Checking the current input signal** 32

Listening to radio broadcasts

- Tuning into a radio station** 33
- Using RDS (Radio Data System)** 34
- RDS Auto Memory** 34
- Presetting radio stations manually** 35
- Receiving preset stations** 35
- Receiving preset stations in order (P.CALL)** 36
- Tuning by program type (PTY search)** 37
- Using the DISPLAY key**..... 37

Sound adjustment

- Adjusting the sound** 38
 - ACTIVE EQ mode
 - Bass Boost
 - Adjusting the Tone
- Adjustments according to the playing source..** 39
 - Speaker level adjustment
 - Input level adjustment
 - Midnight mode
 - Panorama mode
 - Dimension
 - Center width
 - Center image

Convenient functions

- Convenient functions** 42
 - Display dimmer adjustment
 - Listening with headphones
 - Muting the sound
- Remote control operations for Kenwood DVD players** 43

Troubleshooting

- Troubleshooting**..... 44
 - Resetting the unit
- Glossary** 46
- Specifications** 48

Special Features

● HDMI™(High-Definition Multimedia Interface) repeater function

Compatibility with the HDMI interface can transfer HDTV video and latest high-quality audio. It makes possible entertainment of high-quality video recorded on Blu-Ray discs as well as high-quality audio including multi-channel PCM signal.

● High-quality music playback in Pure Audio Mode

This function reproduces music signals in high quality with high fidelity to original sound. In this mode, the display and the analog video circuitry are turned off to eliminate their effects on the audio circuitry. In addition, the optimum listen mode is selected according to the input music signal.

● True home theater sound

This unit incorporates a wide variety of surround modes to bring you maximum enjoyment from your video software. Select a surround mode according to your equipment or the software you are going to play and enjoy!

	KRF-V6400D	KRF-V5450D
Dolby Digital	✓	✓
Dolby Digital EX	✓	
Dolby Pro Logic II	✓	✓
Dolby Pro Logic IIx	✓	
DTS Digital Surround	✓	✓
DTS-ES	✓	
DTS Neo:6	✓	
DTS 96/24	✓	✓
Multi Channel PCM	✓	✓

● Easy Setup of the speaker

The speaker settings can be completed by simply selecting the room type and the listening position. The audio will be corrected automatically according to the characteristics of the speaker system in use.

● Crossover Frequency Adjustment

The bass frequency from the subwoofer and the other speakers can be adjusted making better sound phase between speakers and natural sound field.

● Lip Sync function (KRF-V6400D only)

This function corrects deviation between the video and audio. Automatic correction is also available provided that all of the playback component, this unit and the TV are connected through HDMI.

Manufactured under license from Dolby Laboratories. Dolby, Pro Logic, and the double-D symbol are trademarks of Dolby Laboratories.

HDMI, the HDMI logo and High-Definition Multimedia Interface are trademarks or registered trademarks of HDMI Licensing, LLC.

Manufactured under license under U.S. Patent #'s: 5,451,942; 5,956,674; 5,974,380; 5,978,762; 6,226,616; 6,487,535; 7,003,467; 7,212,872 & other U.S. and worldwide patents issued & pending. DTS, DTS Digital Surround, ES, and Neo:6 are registered trademarks and the DTS logos, Symbol and DTS 96/24 are trademarks of DTS, Inc. © 1996-2008 DTS, Inc. All Rights Reserved.

Before use

How to read this manual

The operating instructions given in this manual assume that the user mainly operates the receiver using the remote control unit. When the same operation is also available on the main unit, the operating method is indicated in illustrations. The [VOLUME CONTROL], [MULTI CONTROL] and [INPUT SELECTOR] knobs on the main unit are operated by turning the knobs clockwise or counterclockwise.

Before use

This icon indicates that the function can be operated (or recommended to operate) only with the unit displayed with the icon.

 : main unit  : remote control unit

Speaker setup (Detailed Setup)

The detailed settings allow you to enjoy full performance of the receiver according to the environment of your listening room.

For creating the best listening environment, Kenwood recommends to perform the setup at the listening position.

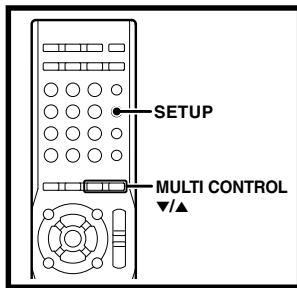

The knob on the main unit is pointed with an arrow to indicate that it can be turned in either direction.

Playback

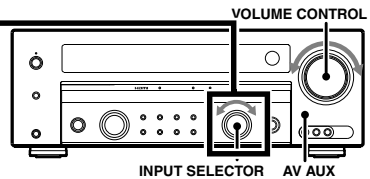

The keys and controls used in the operations described in each section are indicated with their names.

The descriptions of the functions available only on the remote control unit are accompanied only with the illustration of the remote control unit. The descriptions of the functions available only on the main unit are accompanied only with the illustration of the main unit.

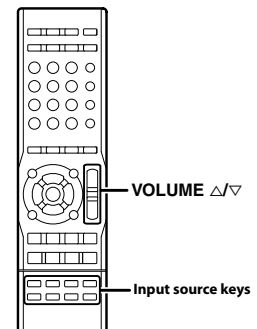

Speaker setup flow

Speaker settings consist of 6 elements.

1 Enter the Detailed Setup mode.

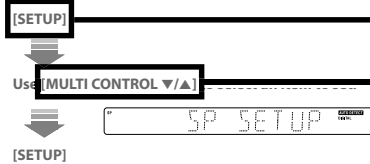

The names of the operated keys or knobs are enclosed inside brackets.

Elements	Display	Setting
Speaker Configuration	"SP SETUP"	Selects whether each speaker channel is used or, if used, its size.
Speaker Level	"TESTTONE"	Selects the output level from each speaker.
Speaker Distance	"DISTANCE"	Selects the distance between each speaker and the listening position.
Crossover	"CROSSOVER"	Sets the lower limit of the bass frequencies reproduced from the speakers set to "NML" in the "SP SETUP". The frequencies below the frequency set here are distributed to other speakers (those set to "LRG" and the subwoofer).

When a key is used to select an option, the list of options is shown in the form of a table.

2 Set each item.

See the followings for each setup item.

This icon indicates supplementary information, restrictions in operation or tips on operation.

1 Select a source.

Use the Input source keys on the remote control unit to select a source. Or use [INPUT SELECTOR] knob or [AV AUX] key on the main unit.

Example: Display when HDMI 1 input source is selected



2 Start playback from the selected source.

3 Use [VOLUME] to adjust the volume.

4 Enjoy various surround effects.

You can enjoy a variety of listen modes. (See <Surround play using the listen mode> -[32].) The surround effects can be fine tuned according to the selected input source. (See <Adjustments according to the playing source> -[39].)

The AV AUX input cannot be selected with the [INPUT SELECTOR] knob of this unit. This input should be selected using the [AV AUX] on this unit or the [AV AUX] key on the remote control unit.

This icon indicates that the description continues on the next page.



- In this manual, KRF-V6400D is used for the illustrations of front panel and rear panel.
- The illustrations of the main unit display panel and the examples of operations are shown for the purpose of explanation and may differ from the actual view or operation.

Names and functions of parts

Main unit

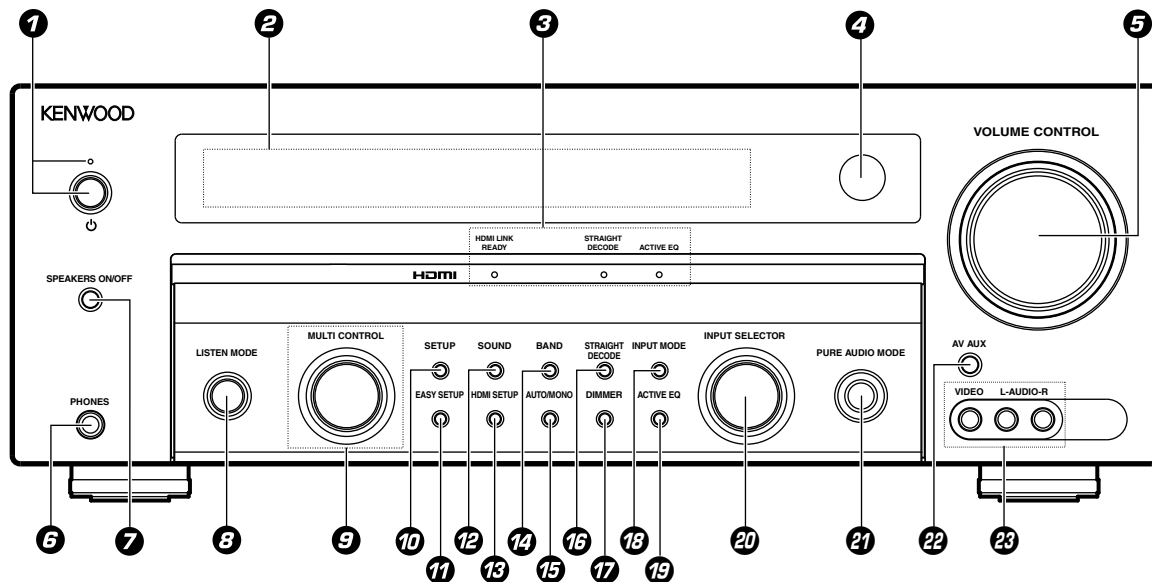

Before use

- 1** **(Power) key**
Standby indicator
Press to switch this unit ON or to put it to standby.
The standby indicator lights in the standby mode.
- 2** **Display**
- 3** **Indicators**
HDMI LINK READY indicator
Lights up when the HDMI link is on.
STRAIGHT DECODE indicator
Lights up when STRAIGHT DECODE mode is on.
ACTIVE EQ indicator
Lights up when ACTIVE EQ mode is on.
- 4** **Remote sensor**
- 5** **VOLUME CONTROL knob**
- 6** **PHONES jack**
Use for headphone listening.
- 7** **SPEAKERS ON/OFF key** → 28
Press to turn the speakers ON/OFF.
- 8** **LISTEN MODE knob** → 32
Turn to select the listen mode.
- 9** **MULTI CONTROL knob**
Turn to select a setting item.
- 10** **SETUP key** → 23
Press to set up this unit.
- 11** **EASY SETUP key** → 22
Use for Easy Setup of the speakers.
- 12** **SOUND key** → 39
Use to adjust the sound quality and ambience effects.
- 13** **HDMI SETUP key** → 26
Use for HDMI Setup.
- 14** **BAND key** → 33
Press to select the broadcasting band.
- 15** **AUTO/MONO key** → 33
Press to switch the radio tuning mode between auto tuning and manual tuning.
- 16** **STRAIGHT DECODE key** → 29
Press to switch the STRAIGHT DECODE mode ON/OFF.
- 17** **DIMMER key** → 42
Press to switch the brightness of the display and indicators.
- 18** **INPUT MODE key** → 28
Press to select the input mode.
- 19** **ACTIVE EQ key** → 38
Press to switch the ACTIVE EQ function ON/OFF.
- 20** **INPUT SELECTOR knob**
Turn to select the input source.
- 21** **PURE AUDIO MODE key** → 30
Press to switch the PURE AUDIO MODE ON/OFF.
- 22** **AV AUX key**
Press to switch the input source to AV AUX.
- 23** **AV AUX jacks**
Connect a video camera, videogame machine, etc.

Standby mode

While the standby indicator is lit, a small amount of power is supplied to the system to back up the memory. This is called standby mode. Under the condition, the system can be turned ON by the remote control unit.

Remote control unit

Before use

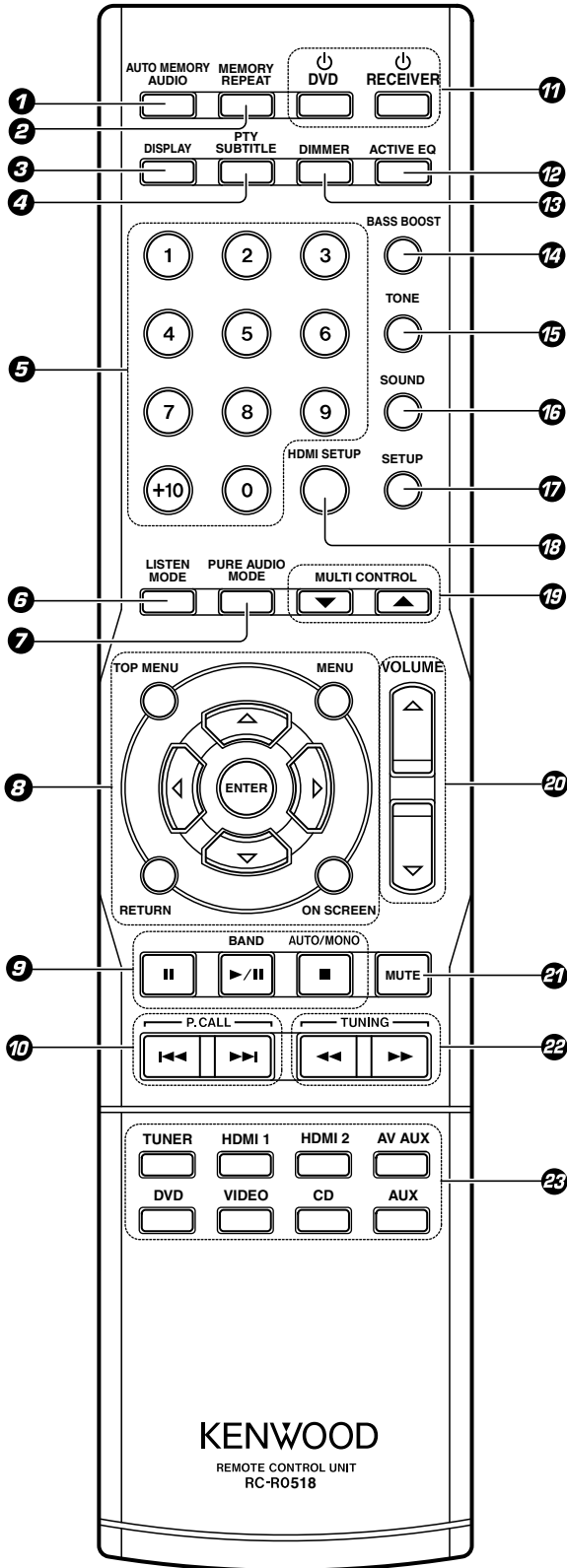

- 1 AUTO MEMORY key** → 34
Use for auto memory of RDS and FM radio stations.
- AUDIO key**
Use to operate the Kenwood DVD player.*
- 2 MEMORY key** → 35
Press to preset radio stations in memory.
- REPEAT key**
Use to operate the Kenwood DVD player.*
- 3 DISPLAY key**
Press to display the type of surround format. → 32
Press to display RDS information. → 37
- 4 PTY key** → 36
Press to search a radio station by program type.
- SUBTITLE key**
Use to operate the Kenwood DVD player.*
- 5 Numeric keys**
Use to recall a preset radio station. → 35
Use to operate the Kenwood DVD player.*
- 6 LISTEN MODE keys** → 32
Press to switch the listen mode.
- 7 PURE AUDIO MODE key** → 30
Press to switch the PURE AUDIO MODE function ON/OFF.
- 8 Δ/▽/◀/▶ keys**
ENTER key
TOP MENU key
MENU key
RETURN key
ON SCREEN key
Use to operate the Kenwood DVD player.*
- 9 II key**
Use to operate the Kenwood DVD player.*
- BAND key** → 33
Press to select the broadcasting band.
▶/II key
Use to operate the Kenwood DVD player.*
- AUTO/MONO key** → 33
Press to switch the radio tuning mode between auto tuning and manual tuning.
■ key
Use to operate the Kenwood DVD player.*
- 10 P.CALL ◀◀/▶▶ keys**
Press to recall a preset radio station. → 36
Use to operate the Kenwood DVD player.*
- 11 RECEIVER key**
Use to turn this unit on and off.
DVD key → 43
Press to switch the Kenwood DVD player ON/OFF.
- 12 ACTIVE EQ key** → 38
Press to switch the ACTIVE EQ function ON/OFF.

- 13 DIMMER key** → 42
Press to switch the brightness of the display and indicators.
- 14 BASS BOOST key** → 38
Press to enhance bass sound.
- 15 TONE key** → 38
Press to adjust the tone.
- 16 SOUND key** → 39
Press to adjust sound quality and acoustic field.
- 17 SETUP key** → 23
Press to set up this unit.
- 18 HDMI SETUP key** → 26
Use for HDMI Setup.
- 19 MULTI CONTROL ▼/▲ keys**
Press to select a setting item.
- 20 VOLUME ▲/▼ keys**
- 21 MUTE key** → 42
Press to mute the sound temporarily.
- 22 TUNING ◀/▶ keys**
Press to select a radio station. → 33
Use to operate the Kenwood DVD player.*
- 23 Input source keys**
Press to select the input source.



* For how to be able to use the keys to operate the Kenwood DVD player, see <Remote control operations for Kenwood DVD players>. → 43

Operation

Operate the remote control unit by pointing it to the remote sensor of this unit.

When this unit is in standby mode (which is indicated by lighting of the standby indicator), pressing the [RECEIVER] key turns this unit ON. Pressing the [RECEIVER] key again turns this unit OFF (standby mode).

When operating the connected components, always press the input source key of the component you need to operate first to switch the remote control unit to the selected input source mode, and then press the keys of the corresponding operation.

Operating range (Approx.)

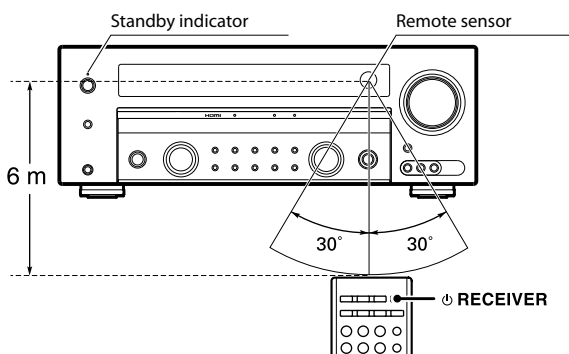

Loading batteries

1 Remove the cover.

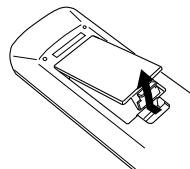

2 Insert batteries.

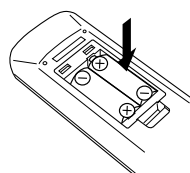

Insert two (R03) batteries following the polarity indications.

3 Close the cover.

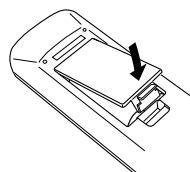

- The supplied batteries may have shorter lives than ordinary batteries due to use during operation checks.
- When the remote-controllable distance gets shorter than before, replace both batteries with new ones.

CAUTION

Do not leave the battery near fire or under direct sunlight. A fire, explosion or excessive heat generation may result.

Before use

Display

Before use

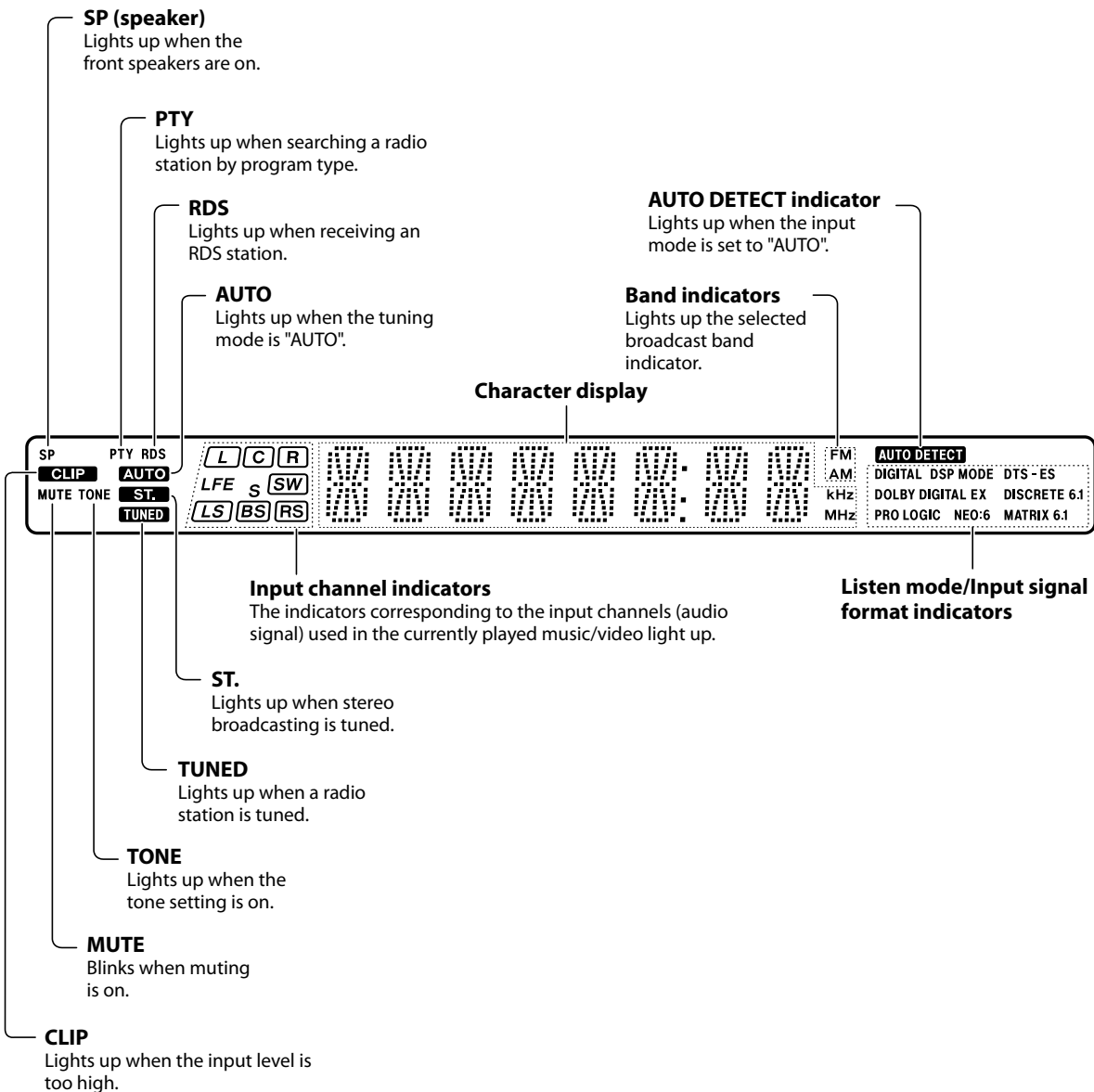

Notes on connections

CAUTION

Do not connect the power cord to a wall outlet until all connections are completed.

When connecting the related system components, be sure to refer to the instruction manuals supplied with the components you are connecting.



- Be sure to remove the power cord from the AC outlet before plugging or unplugging any connection cords. Plugging/unplugging connection cords without disconnecting the power cord can cause malfunctions and may damage the unit.
- Be sure to insert all connection cords securely. If their connections are imperfect, the sound and video may not be produced or there will be noise interference.
- If this unit is installed in the proximity of a source of magnetism such as a magnet, color irregularities due to interference with the speakers may be observed on the TV monitor screen. Be careful in the installation.

Microcomputer malfunction

If operation is not possible or an erroneous display appears, even though all connections have been made properly, reset the microcomputer by referring to <Resetting the unit>. → 45

CAUTION

The power of this equipment will not be completely cut off from the wall outlet when the power switch is turned off. Install the equipment so that the wall outlet is easily accessible and, in case of emergency, immediately unplug the power cord from the wall outlet.

CAUTION

Be sure to adhere to the following, or proper ventilation will be blocked causing damage or fire hazard.

- Do not install the unit on the rear, side or top panel.
- Do not cover the unit with a cloth or install the unit on a carpet or mattress.
- Do not install the unit in a poorly ventilated place.
- Leave some space around the unit (from the largest outside dimension including projection) equal to or greater than, shown below.

Top panel : 50 cm
Side panel : 10 cm
Back panel : 10 cm

Speaker placement

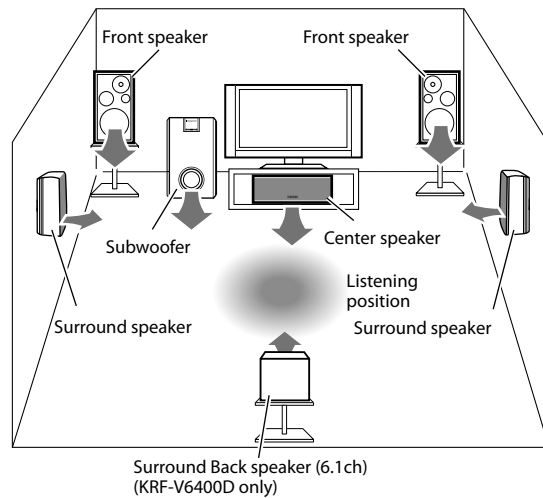

Connections

Front speakers

Install in the front left and right positions. Symmetrical installation is ideal. The front speakers are always used regardless of the listen mode.

Center speaker

Install in the front center position. This speaker improves the acoustic image positioning and reproduction of sound movement.

Surround speakers

Install straight on or slightly behind the left and right of the listening position, at in an as high as possible height (ideally one meter above the height of the listener's ears). Symmetrical installation is ideal. The surround speakers reproduce the feeling of movement and presence of sound.

Subwoofer

In general, install on the front center position near the front speakers. The subwoofer reproduces the powerful bass effects. As it is less directional to other speakers, it can be installed so that the bass can be reproduced best according to the listening room layout.

Surround Back speaker (KRF-V6400D only)

Install on the rear of the listening position, at the same height as the surround speakers.



- Ideal surround play is possible when all of the speakers above are installed. If the center speaker and/or the subwoofer is not installed, the system optimizes playback according to the current system by assigning the sound of absent channels to other speakers.
- KRF-V5450D :
Up to two subwoofers can be connected to KRF-V5450D. See <Connecting speakers> → 18 for how to connect the subwoofers.

Connecting components equipped with HDMI terminals

The HDMI connection can transfer both the video and audio signals through a single HDMI cable. It makes possible entertainment of high-quality video recorded on Blu-ray discs as well as high-quality audio including multi-channel PCM audio. The HDMI connection also enables interlocking of the power of the TV with that of this unit and adjustment of the volume of this unit from the TV. (See <HDMI setup> → [26].)

1 Using an HDMI cable, connect the HDMI input terminal ([HDMI 1] or [HDMI 2] terminal) of this unit to the HDMI output terminal of a playback component such as a Blu-ray disc player.

2 Using another HDMI cable, connect the [HDMI MONITOR OUT] terminal of this unit to the HDMI input terminal of the TV monitor.

Connections

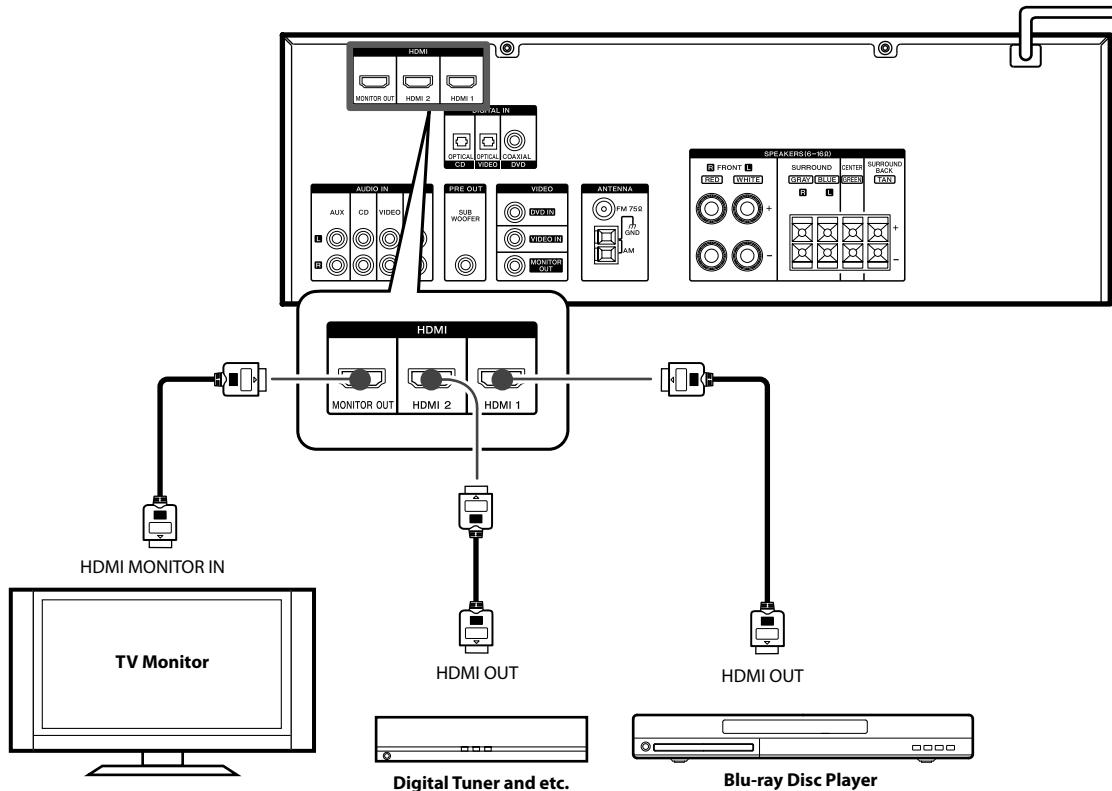

Using the HDMI function

The HDMI setup is required to use the HDMI function. See <HDMI setup> → [26].

Flow of video signal

The digital video signal input from the HDMI input terminal is output only at the HDMI monitor output terminal.

Flow of audio signal

The digital audio signal input from the HDMI input terminal is output at the speakers connected to this unit. It can also be output at the TV monitor connected to this unit according to the HDMI setup. (See <HDMI setup> → [26].)



- An HDMI/DVI converter cable is necessary to connect a TV monitor with a DVI input terminal. The TV monitor also needs to be compatible with HDCP (High-bandwidth Digital Contents Protection). Note that the video may be unable to be monitored depending on the combined components.
- Use an HDMI-certified category 2 cable (High Speed HDMI™ Cable) for the connection.
- When components are connected through the HDMI connection, it takes a certain period before the video/audio are output because they need mutual authentication.
- If the video and/or audio are not output normally, turn all of the connected components off then on, and try again.
- If the resolution of the incoming video signal is different from that of the TV, no video is output. In this case, adjust the resolution on the connected component.

Connecting a TV Monitor

1 Connect the TV monitor by selecting one of the desired method from connections **A** or **C** shown below.

For the video and audio connections of the connected component, see the description on the page for the connected components.

2 To output the audio of the TV monitor from the speakers connected to this unit:
Use connection **B** (analog).



The HDMI video cannot be viewed unless the TV monitor is equipped with the HDMI terminal.

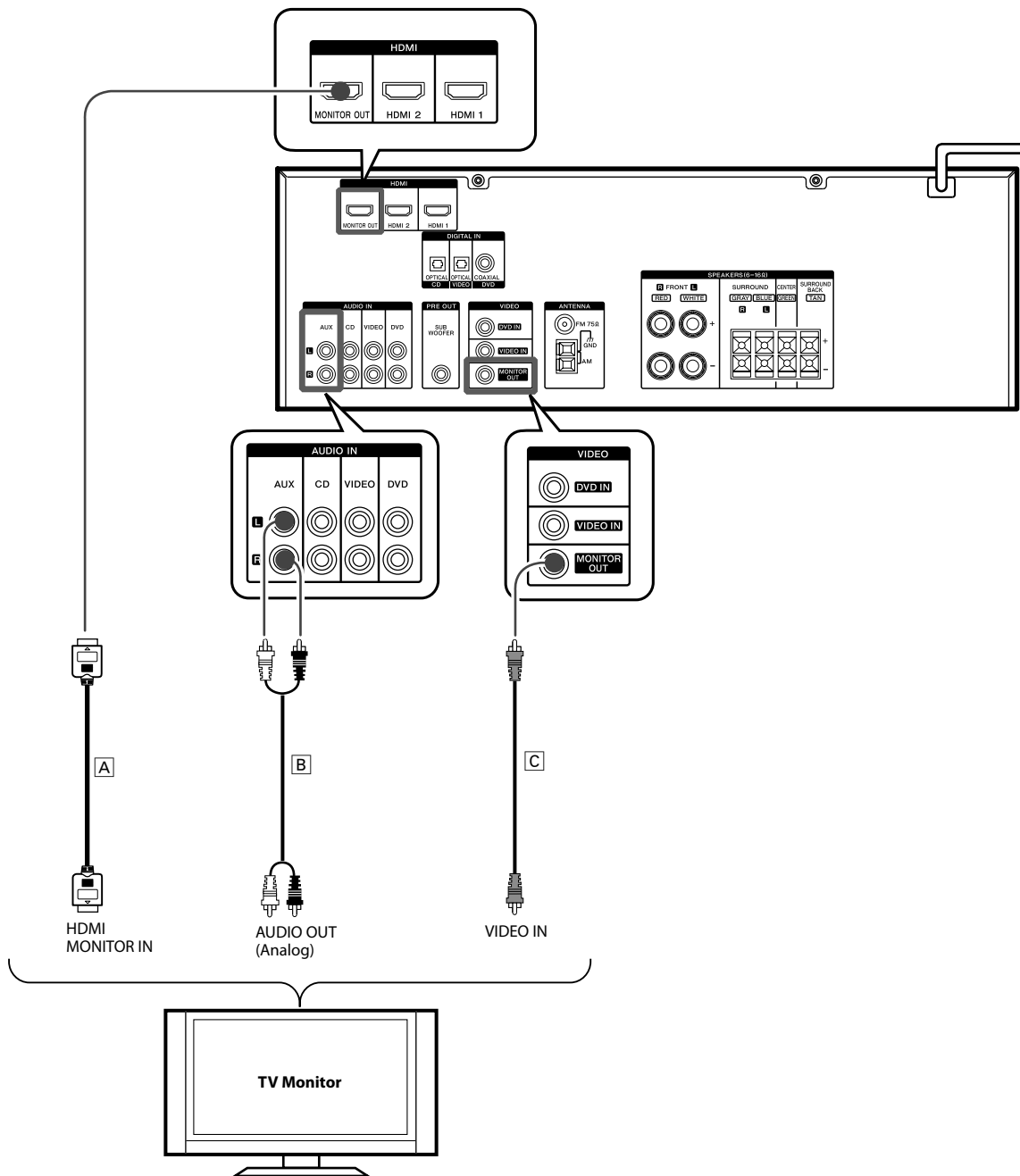

Connecting a CD player

1 Connect the audio line: Connection **B** (digital) or **A** (analog).

Connections

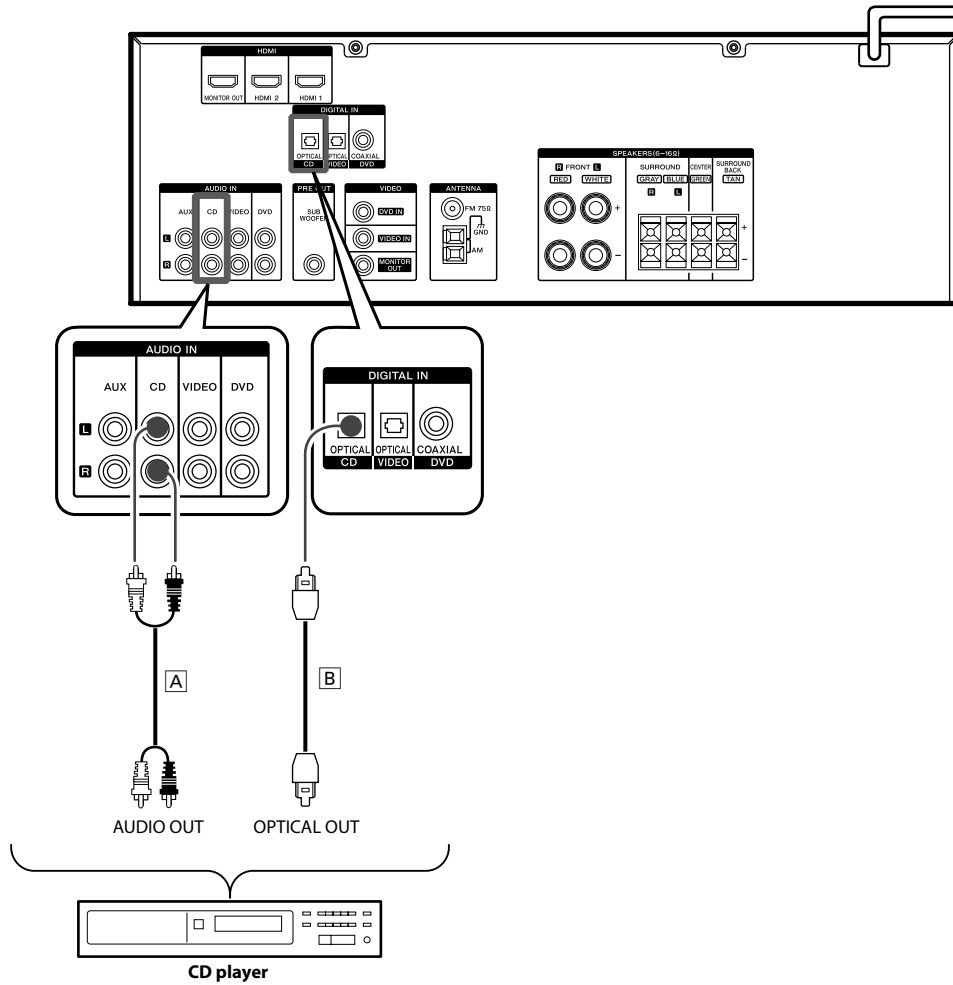

Connecting a DVD player

- 1** Connect the audio line: Connection **B** (digital) or **A** (analog).
- 2** Connect the video line: Connection **C**.
- 3** Connect the TV monitor.

Connect as shown in <Connecting a TV Monitor> → [13](#).

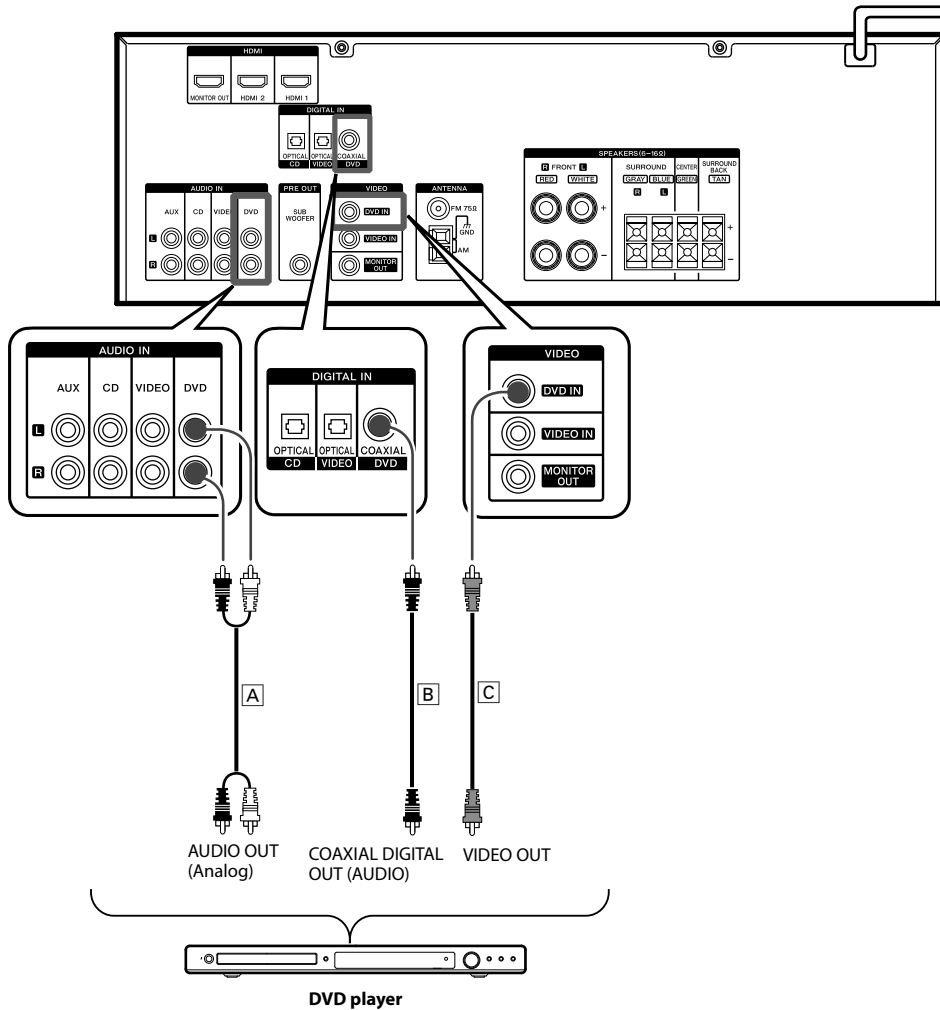

• When the connected DVD player and/or TV monitor have the HDMI terminals, it is recommended to use the HDMI connection. (See <Connecting components equipped with HDMI terminals> → [12](#).)

Connecting a video player

1 Connect the audio line: Connection **B** (digital) or **A** (analog).

2 Connect the video line: Connection **C**.

3 Connect the TV monitor.

Connect as shown in <Connecting a TV Monitor> → **13**.

Connections

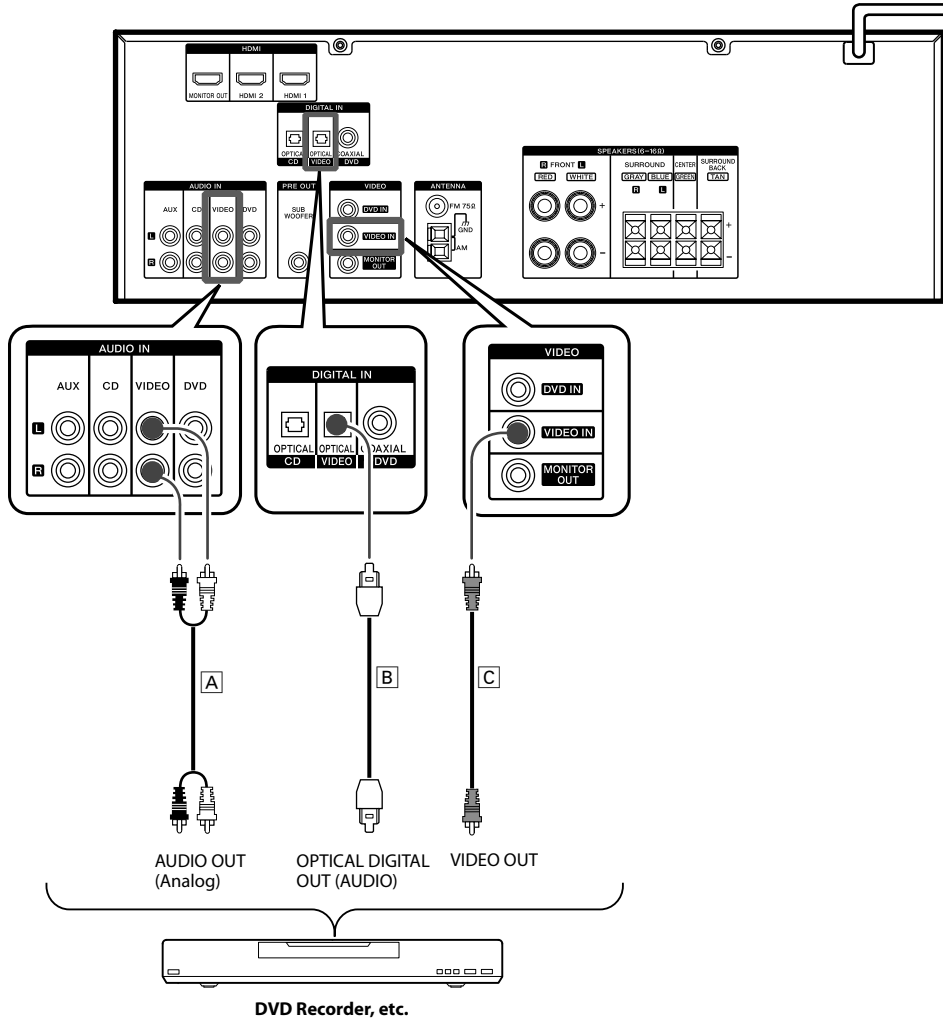

• When the connected Video player and/or TV monitor have the HDMI terminals, it is recommended to use the HDMI connection. (See <Connecting components equipped with HDMI terminals> → **12**.)

Connecting an audio player

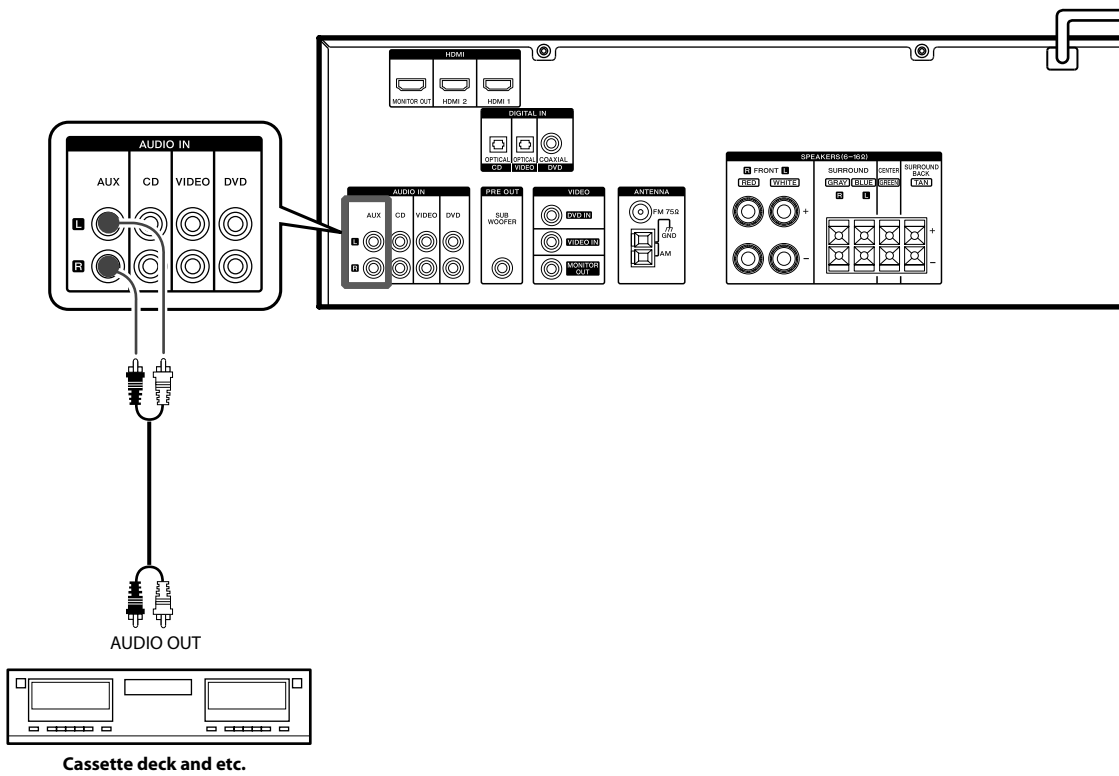

Connections

Connecting to the [AV AUX] jacks

A component that is usually not connected to this unit, such as a portable video camera, can be connected to the [AV AUX] jacks on the front panel of this unit.

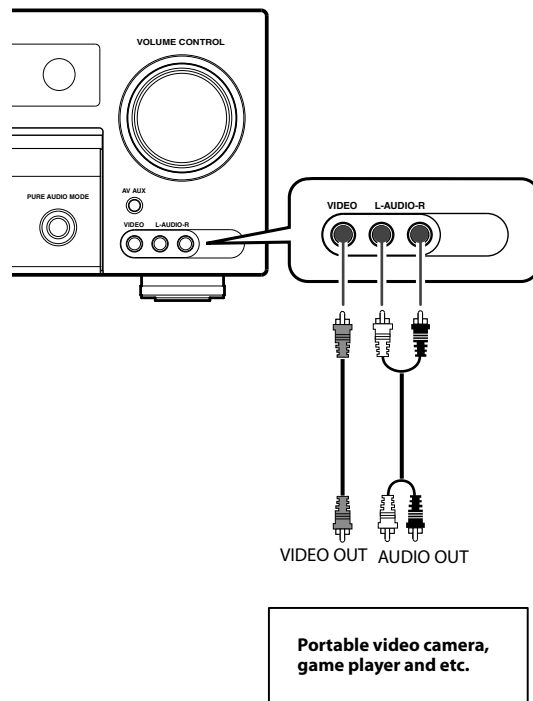

Connecting speakers

Connections

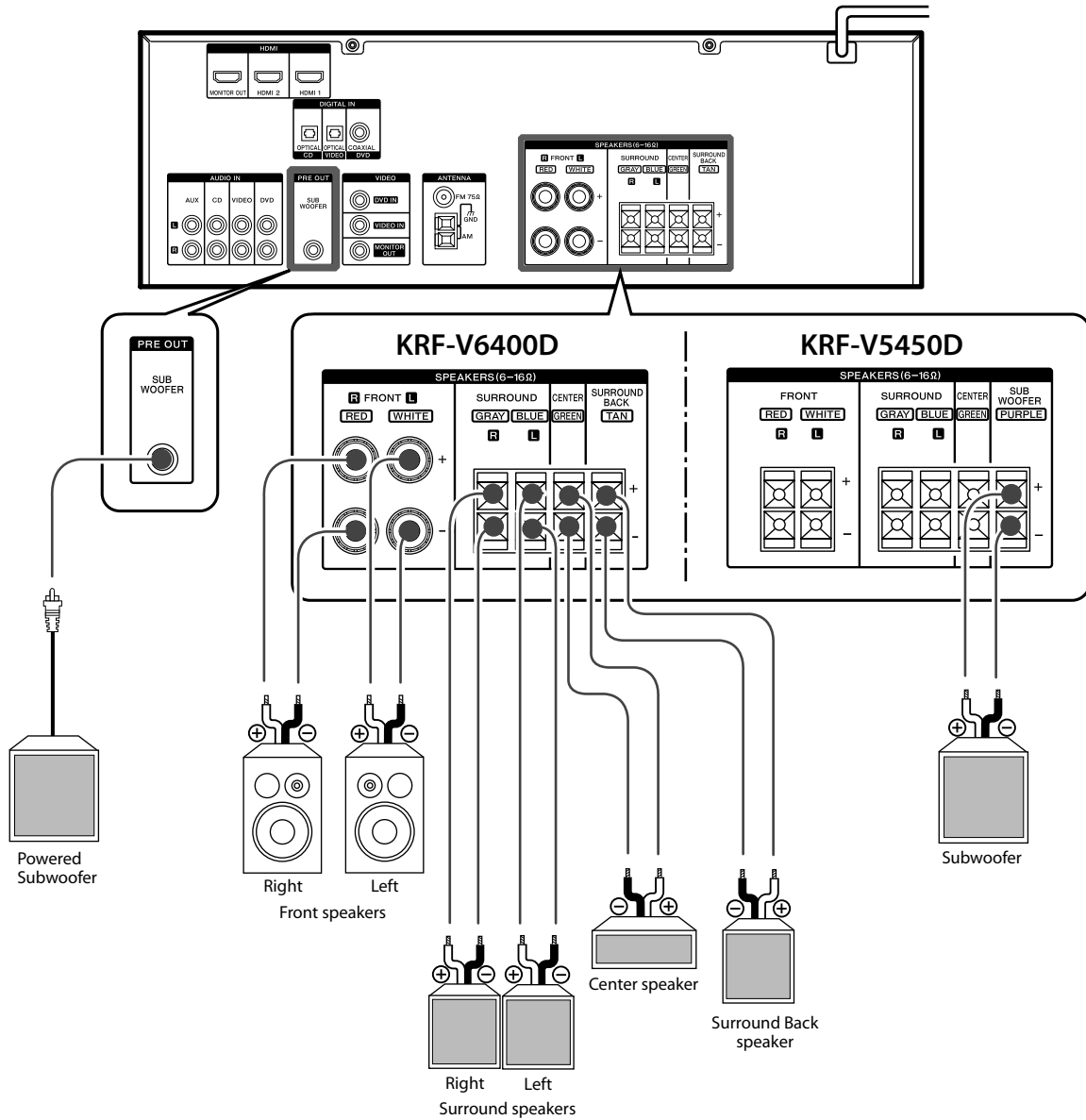

- Speaker impedance : 6 – 16Ω
- Never short circuit the + and – speaker cords.
- If the left and right speakers are connected inversely or the speaker cords are connected with reversed polarity, the sound will be unnatural with ambiguous acoustic imaging. Be sure to connect the speakers correctly.
- KRF-V5450D :
Subwoofer sound comes out at the both Subwoofer terminals (SPEAKERS and PREOUT) simultaneously.

**How to connect the wire to terminals
(Screw type terminal) (KRF-V6400D only)**

- 1** Strip the vinyl coating of the wire by a length of about 1 cm.



- 2** Loosen the knob.

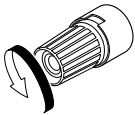

- 3** Insert the wire.

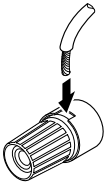

Insert until the metallic conductor becomes invisible.

- 4** Tighten the knob.

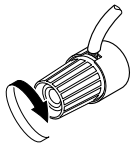

**How to connect the wire to terminals
(Push type terminal)**

- 1** Strip the vinyl coating of the wire by a length of about 1 cm.



- 2** Push the lever.

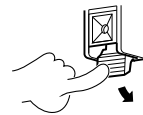

- 3** Insert the wire.

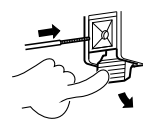

Insert until the metallic conductor becomes invisible.

- 4** Release the lever.

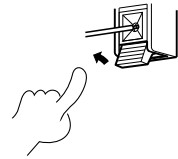

Connecting antennas

The broadcast reception cannot be made unless the antennas are connected. Connect the antennas correctly as instructed below.

Connections

FM indoor antenna

Fix on a wall, etc. with a good reception condition. The provided antenna is intended for temporary use in indoors. To obtain stable FM reception, it is recommended to use an outdoor antenna. Be sure to disconnect the indoor antenna when an outdoor antenna is installed.

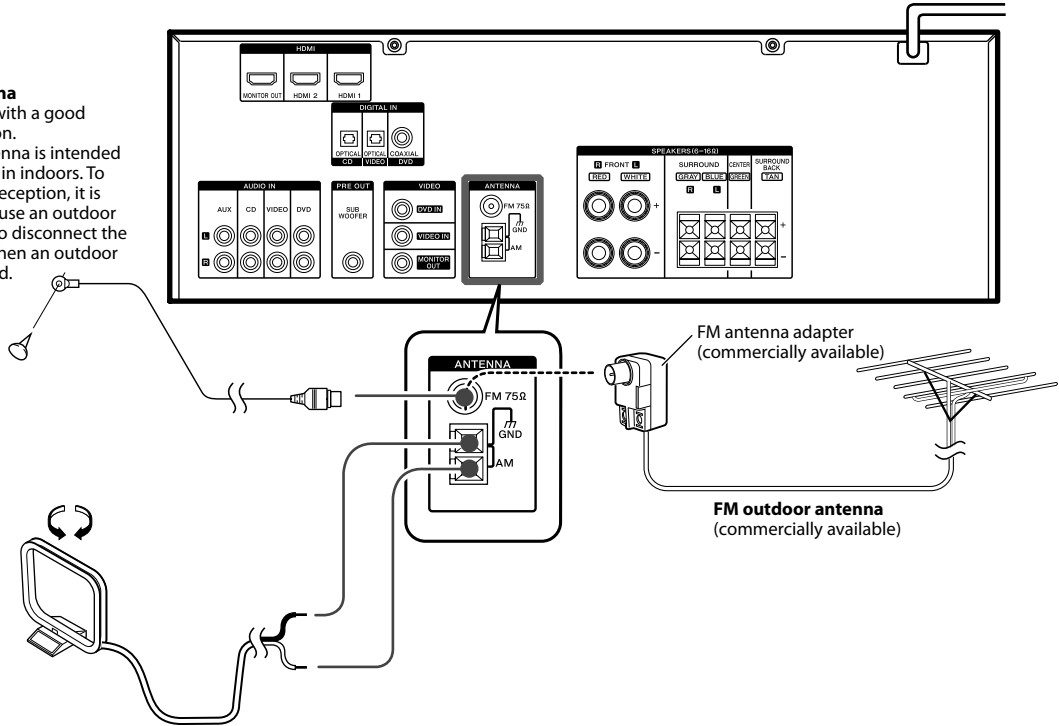

AM loop antenna

Install in a position as apart as possible from this unit, the TV monitor, personal computer, speaker cords and power cord, and place in an orientation that can offer the best reception condition.

AM loop antenna

- 1 Attach to the stand.

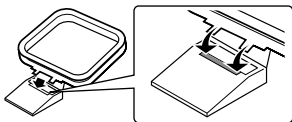

Insert into the groove.

- 2 Push the lever.



- 3 Insert the antenna cord.

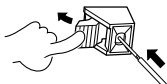

Insert until the metallic conductor becomes invisible.

- 4 Release the lever.

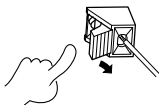

FM indoor antenna

- 1 Insert the antenna cord.

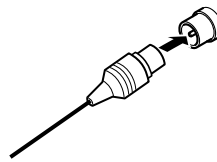

- 2 Fix the antenna on the wall.

FM outdoor antenna

Lead the 75Ω coaxial cable connected to the FM outdoor antenna into the room and connect it to the FM 75Ω terminal.

⚠ Caution for outdoor antenna installation

Since antenna installation necessitates skill and experience, always consult your dealer before installation. The antenna should be placed at a distance from the power distribution wires. Otherwise, an electric shock accident may occur if the antenna falls down.

Turning this unit ON

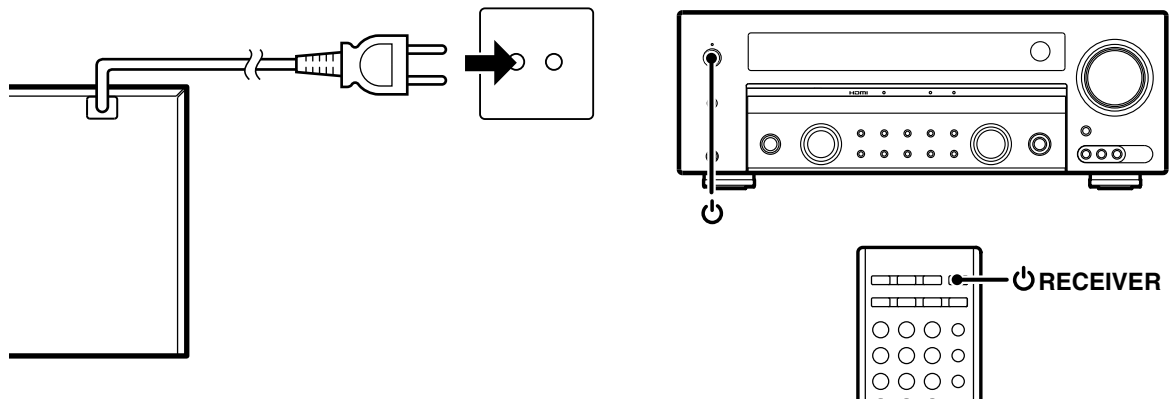

1 After completing all of the necessary connections, connect the power cord to a wall power outlet.

The standby indicator on the front panel lights red to indicate the standby mode.

2 Press the [⏻ (Power)] key of this unit or the [⏻ RECEIVER] key of the remote control unit to turn this unit ON.

The standby indicator on the front panel goes out and the display panel lights up.

To turn this unit OFF (standby mode)

Press the [⏻ (Power)] key of this unit or the [⏻ RECEIVER] key of the remote control unit.

Speaker setup (Easy Setup)

The speaker settings can be completed by simply selecting the room type and listening position. The audio will be corrected automatically according to the characteristics of the speaker system in use.
If more detailed speaker settings are required, use the procedure in <Speaker setup (Detailed Setup)> [↗](#).

Reference for listening room size

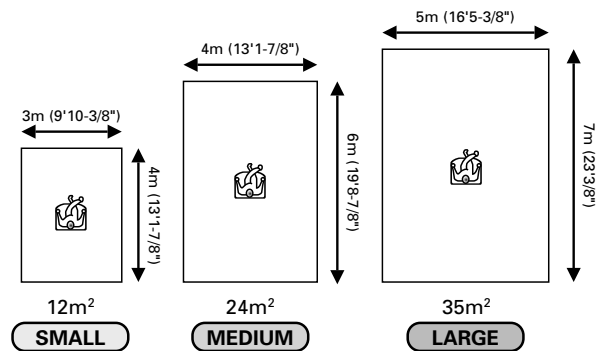

Reference for listening position

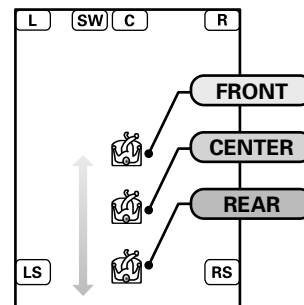

Setup

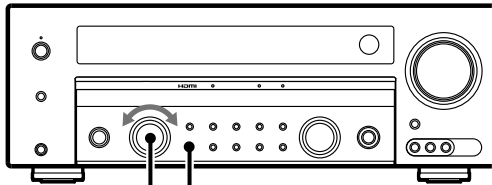

MULTI CONTROL EASY SETUP

1 Press [EASY SETUP] to enter the Easy Setup mode.

2 Set the listening room size.

Use [MULTI CONTROL] to select your room type.

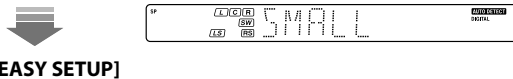

[EASY SETUP]

3 Select the listening position.

Use [MULTI CONTROL] to select your listening position.



[EASY SETUP]

The unit exits the Easy Setup mode, and the speakers are set up as shown below.

- Subwoofer ➔ ON
- Front speaker ➔ Average size
- Center speaker ➔ Average size
- Surround speaker ➔ Average size
- Surround Back speaker ➔ OFF
- Subwoofer Re-mix ➔ ON

For details on the setting contents, see <Speaker setup (Detailed Setup)> [↗](#).



- Easy setup with may not be appropriate with certain speaker systems or listening environment. In this case, go through <Speaker setup (Detailed Setup)>.
- Easy setup can set only the 5.1 channel system.
For KRF-V6400D : If the setup for 6.1-channel system is required, go through <Speaker setup (Detailed Setup)>.
- Surround Back speaker : KRF-V6400D only
- Subwoofer Re-mix:
Mixes the bass tone of other channels to the subwoofer channel.

Speaker setup (Detailed Setup)

The detailed settings allow you to enjoy full performance of the receiver according to the environment of your listening room.

For creating the best listening environment, Kenwood recommends to perform the setup at the listening position.

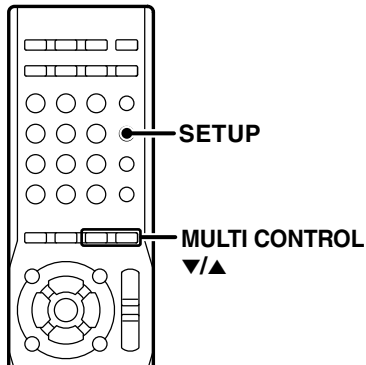

Speaker setup flow

Speaker settings consist of 6 elements.

1 Enter the Detailed Setup mode.

[SETUP]



Use [MULTI CONTROL ▼/▲] to select an item to set.

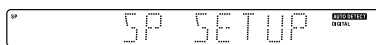

[SETUP]

Elements	Display	Setting
Speaker Configuration	"SP SETUP"	Selects whether each speaker channel is used or, if used, its size.
Speaker Level	"TESTTONE"	Selects the output level from each speaker.
Speaker Distance	"DISTANCE"	Selects the distance between each speaker and the listening position.
Crossover	"CROSSOVER"	Sets the lower limit of the bass frequencies reproduced from the speakers set to "NML" in the "SP SETUP". The frequencies below the frequency set here are distributed to other speakers (those set to "LRG" and the subwoofer).
Low Frequency Effects Level	"LFE LVL"	Selects the level of bass audio enhancement. Low Frequency Effect channel delivers separate non-directional bass signals to the subwoofer for more dynamic deep bass sound effects.
Lip Sync (KRF-V6400D only)	"LIP SYNC"	Adjusts the deviation in time between the video and audio.
	"EXIT"	Exits the Detailed Setup mode.

2 Set each item.

See the followings for each setup item.

Speaker configuration

Select the use of each speaker and its size.

1 Enter the Detailed Setup mode.

[SETUP]



Use [MULTI CONTROL ▼/▲] to select "SP SETUP".



[SETUP]

2 Select the use and size of each speaker.

Use [MULTI CONTROL ▼/▲] to select the speaker and its use or size.

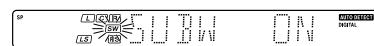

[SETUP]

Repeat the above operations until all of the speakers have been set up.

Speaker	Display	Setting
Subwoofer	"SUBW ON"	Subwoofer is connected.
	"SUBW OFF"	Subwoofer is not connected.
Front speaker	"FRNT LRG"	Large size front speaker
	"FRNT NML"	Average size front speaker
	"CNTR LRG"	Large size center speaker
Center speaker	"CNTR NML"	Average size center speaker
	"CNTR OFF"	Center speaker is not connected.
	"SURR LRG"	Large size surround speaker
Surround speaker	"SURR NML"	Average size surround speaker
	"SURR OFF"	Surround speakers are not connected.
Surround Back speaker (KRF-V6400D only)	"BS LRG"	Large size surround back speaker is connected. (6.1ch)
	"BS NML"	Average size surround back speaker is connected. (6.1ch)
	"BS OFF"	Surround back speaker is not connected.
Subwoofer Re-mix*1	"RMX ON"	Subwoofer re-mix is on.
	"RMX OFF"	Subwoofer re-mix is off.

*1 Mixes the bass tone of other channels to the subwoofer channel.

3 Go to the next setting.

Continued

Speaker setup (Detailed Setup)

Setup



- Reference for speaker size
 "LRG"(Large) : A speaker with a sufficient bass reproduction capability (a speaker with a large woofer or a large cabinet size).
 "NML"(Normal) : A speaker with a lower bass reproduction capability than the "LRG" speakers (the bass frequencies will be output from the speakers set to "LRG" and the subwoofer).

If you cannot identify the size of a speaker, it is recommended to set it to "NML".

- When "SUBW OFF" is selected, the front speakers are automatically set to "FRNT LRG".
- For "FRNT LRG" selection, no sound will be heard from subwoofer even it is set to ON. If you set the Subwoofer Remix to "RMX ON", you will be able to hear sound from the subwoofer.
- When in STEREO mode, the sound goes directly to front speakers.
- If "FRNT NML" is selected, "LRG" cannot be selected for the other speakers.
- If "CNTR NML" or "CNTR OFF" is selected, "SURR LRG" cannot be selected.
- If "SURR OFF" is selected, no surround back speaker can be selected.
- If "SURR NML" is selected for surround speakers, "BS LRG" cannot be selected for the surround back speaker.

Speaker Level

Adjust the volume level of the speakers so that all of them are approximately identical.

1 Select "TEST TONE".

[SETUP]



[MULTI CONTROL ▼/▲]



[SETUP]

SP TESTTONE

2 Select the test tone output method.

[MULTI CONTROL ▼/▲]



[SETUP]

SP AUTO

Display	Setting
"AUTO"	The test tone is heard from the speakers one after another with 2 seconds each.
"MANUAL"	You can select the speaker channel from which the test tone is output.

3 Adjust the volume level of each speaker.

If you select "AUTO" :

When you hear the test tone from the speaker which you wish to adjust, use [MULTI CONTROL ▼/▲] and adjust the volume of the test tone. When you finish adjusting, press [SETUP].

If you select "MANUAL" :

Use [MULTI CONTROL ▼/▲] to adjust its volume level and press [SETUP]. You will hear the test tone from the next speaker.

Channel indicator to be adjusted blinks.

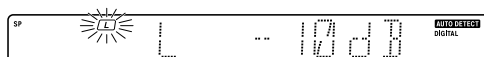

4 Go to the next setting.

Speaker Distance

Sets the distance between each speaker and the listening position. The actual distances should be measured before starting this setup.

Distances of speakers

Speaker	Input channel indicator	Distance from the listening position
Front speaker (left)	"L"	meters (feet)
Center speaker	"C"	meters (feet)
Front speaker (right)	"R"	meters (feet)
Surround speaker (right)	"RS"	meters (feet)
Surround Back speaker (KRF-V6400D only)	"BS"	meters (feet)
Surround speaker (left)	"LS"	meters (feet)
Subwoofer	"SW"	meters (feet)

1 Select "DISTANCE".

[SETUP]



[MULTI CONTROL ▼/▲]



[SETUP]

SP DISTANCE

2 Set the distance.

Refer to the table above for the distance from each speaker to this unit.

Adjustment starts from front left speaker.

Use [MULTI CONTROL ▼/▲] to set the distance.



[SETUP]

SP 10FT 30M

The distance can be set in the range of 0.3 to 9.0 meters (1 to 30.0 ft) in 0.3-meter (1-foot) increments.

3 Repeat step 2 for each speaker until the distances of all speakers are set.

4 Go to the next setting.

Crossover

The crossover frequency is the lower limit of the bass frequencies reproduced from the speakers set to "NML" in the <Speaker configuration>. The frequencies below the set crossover frequency are output from other speakers (those set to "LRG" and the subwoofer).

1 Select "CROSSOVER".

[SETUP]



[MULTI CONTROL ▼/▲]



CROSSOVER

[SETUP]

2 Set the crossover frequency.

Use [MULTI CONTROL ▼/▲] to select crossover frequency.



F 60HZ

[SETUP]

The frequency is selected from 40, 60, 80, 100, 120, 150 and 200Hz.

3 Go to the next setting.

LFE (Low Frequency Effect) Level

Low frequency effect signal is used exclusively for giving the field effect of bass tone in the Dolby Digital and DTS signal.

1 Select "LFE LVL".

[SETUP]



[MULTI CONTROL ▼/▲]



LFE LVL

[SETUP]

2 Set the LFE level.

Use [MULTI CONTROL ▼/▲] to select the LFE level.



LFE -10dB

[SETUP]

The level is adjusted from 0dB to -10dB in 1dB step decrements.

3 Go to the next setting.

Lip Sync (KRF-V6400D only)

If the monitored video is delayed in time with respect to the audio from the speakers, the audio output timing can be delayed.

1 Select "LIP SYNC".

[SETUP]



[MULTI CONTROL ▼/▲]



LIP SYNC

[SETUP]

2 Set the delay time.

Use [MULTI CONTROL ▼/▲] to select the delay time.



20MS

[SETUP]

The delay time is adjusted from 0ms to 300ms in 10ms step.

3 Press [SETUP] to exit the setup mode.

EXIT



Setup

HDMI setup

The HDMI setup is required to use the component connected to the HDMI terminal or to use the HDMI control functions.

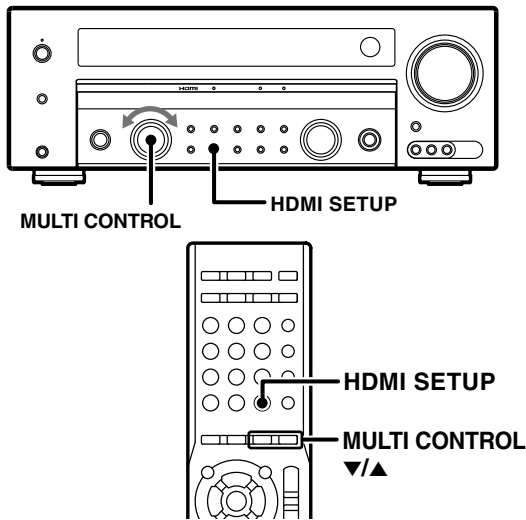

Setup

HDMI setup flow

The HDMI control functions can be set.

1 Enter the HDMI Setup mode.

[HDMI SETUP]



Use [MULTI CONTROL ▼/▲] to select an item to set.



[HDMI SETUP]

Display	Setting
"AUDIO OUT"	Sets the HDMI audio output destination.
"LIP SYNC" (KRF-V6400D only)	Adjusts the deviation in time between the output audio and video.
"LINK SET"	Sets whether or not the HDMI control functions are used.
"POWER CONTROL"*1	Interlocks power ON-OFF of components by means of HDMI control.
"EXIT"	Exits the HDMI Setup mode.

*1 This item can be set when "LINK SET" is set to "ON".

2 Set each item.

See the followings for each HDMI control item.

Audio Out

This function selects whether the output destination of the audio input is the TV or this unit.

1 Select "AUDIO OUT".

[HDMI SETUP]



Use [MULTI CONTROL ▼/▲].



[HDMI SETUP]

2 Set the HDMI audio output destination.

[MULTI CONTROL ▼/▲]



[HDMI SETUP]

Display	Setting
"AMP"	Outputs the audio from the speakers connected to this unit.
"TV"	Outputs the audio from the TV connected to this unit.

3 Go to the next setting.



- If "TV" is selected and the audio is not output or is interfered with by noise, set the audio output of the player component to PCM.
- If "TV" is selected, adjust the volume on TV.

Lip Sync (KRF-V6400D only)

If the monitored video is delayed in time with respect to the audio from the speakers, the audio output timing can be delayed.

1 Select "LIP SYNC".

[HDMI SETUP]



Use [MULTI CONTROL ▼/▲].



SP LIP SYNC HD-SD/SD
DIGITAL

[HDMI SETUP]

2 Set the HDMI audio delay.

[MULTI CONTROL ▼/▲]



SP AUTO HD-SD/SD
DIGITAL

[HDMI SETUP]

Display	Setting
"AUTO"	Corrects the deviation in time between the output audio and video automatically.
"MANUAL"	Allows the user to correct the deviation in time between the output audio and video manually.
"OFF"	The deviation in time between the output audio and video is not corrected.

When "MANUAL" is selected, use [MULTI CONTROL ▼/▲] to select the audio delay time and press [HDMI SETUP] to enter the setting.

The delay time is adjusted from 0ms to 300ms in 10ms step.

3 Go to the next setting.



- If the TV in use is not compatible with "AUTO", select "MANUAL".

HDMI Link

This function selects whether or not the volume control and input selection of this unit are interlocked with the operations of the connected components.

1 Select "LINK SET".

[HDMI SETUP]



Use [MULTI CONTROL ▼/▲].



SP LINK SET HD-SD/SD
DIGITAL

[HDMI SETUP]

2 Set the HDMI link on or off.

[MULTI CONTROL ▼/▲]



SP LINK ON HD-SD/SD
DIGITAL

[HDMI SETUP]

Display	Setting
"LINK ON"	The HDMI control functions are used.
"LINK OFF"	The HDMI control functions are not used.

When "LINK ON" is selected, the "HDMI LINK READY" indicator on the front panel lights up.

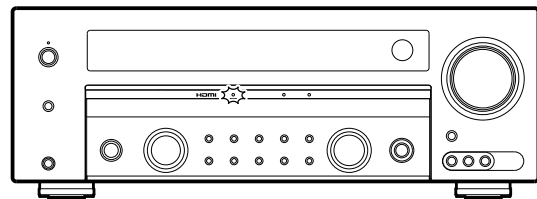

3 If "LINK ON" is set, proceed to the <Power Control> setup.

Power Control

This function selects whether or not the power status of this unit is interlocked with the power ON/OFF and start of playback of the connected components.

1 Set the HDMI power control on or off.

[MULTI CONTROL ▼/▲]



SP PWR ON HD-SD/SD
DIGITAL

[HDMI SETUP]

Display	Setting
"PWR ON"	Turning the TV ON/OFF also turns this unit ON/OFF with an interlocked operation.
"PWR OFF"	The power ON/OFF status of this unit is not interlocked with the power ON/OFF status of the TV.

Setup

Preparation for playing music or movie

Playing music or movie

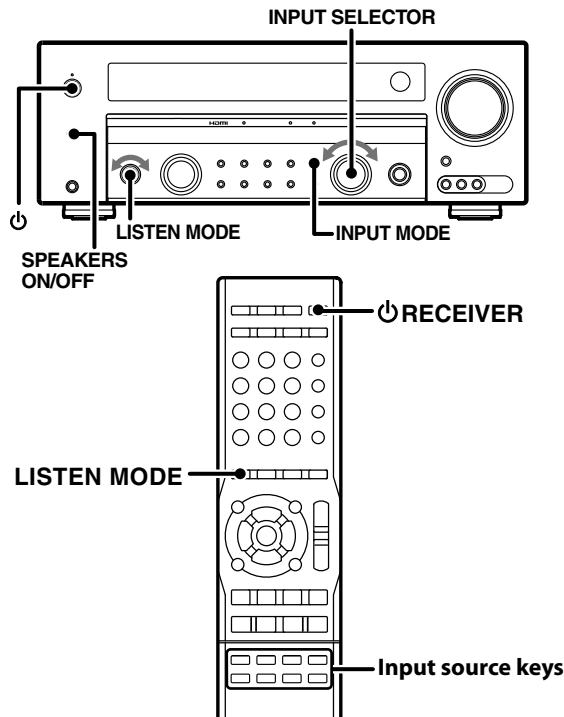

Turning on the power

- 1 Turn the connected monitor and player component ON.
- 2 Press [RECEIVER] (remote control unit) or [RECEIVER] (main unit) to turn on the unit.

Setting the speaker system

Press [SPEAKERS ON/OFF] to select the speaker system(s) to be used.

"SP" indicator lights up when turning on the speaker system.

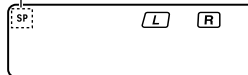

Selecting the input mode

When playing a component connected to the digital input terminal (CD, VIDEO or DVD) or the HDMI input terminal (HDMI 1 or HDMI 2), set the input mode to match the type of the audio input.

- 1 Use [INPUT SELECTOR] to select "HDMI 1", "HDMI 2", "DVD", "VIDEO" or "CD" input source.
- 2 Press [INPUT MODE] to select the input mode.

Each press switches the mode as follows.

When in HDMI 1 or HDMI 2 input source

Display	Setting
"AUTO"	The digital and analog inputs are switched automatically according to the input signal. When a digital input is detected, the decode mode is also switched according to the signal type (Multi-channel PCM/Dolby Digital/DTS).
"MANUAL"	The input mode is fixed at digital to accelerate the input signal processing and eliminate lack of audio at the beginning of playback. The decode mode is also fixed according to the type of the signal to be played.

When in DVD, VIDEO or CD input source

Display	Setting
"AUTO"	The digital and analog inputs are switched automatically according to the input signal. When a digital input is detected, the decode mode is also switched according to the signal type (PCM/Dolby Digital/DTS).
"MANUAL"	The input mode is fixed at digital to accelerate the input signal processing and eliminate lack of audio at the beginning of playback. The decode mode is also fixed according to the type of the signal to be played.
"ANALOG"*1	The input mode is fixed at analog. This is selected for playback of analog player components.

*1 This cannot be selected when in DTS play mode.



- The "AUTO DETECT" indicator lights when "AUTO" is selected.

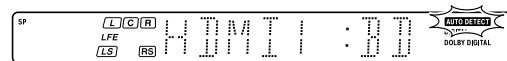

- If the audio is lost as a result of change in the input signal while "MANUAL" is selected, press [LISTEN MODE].

Playback

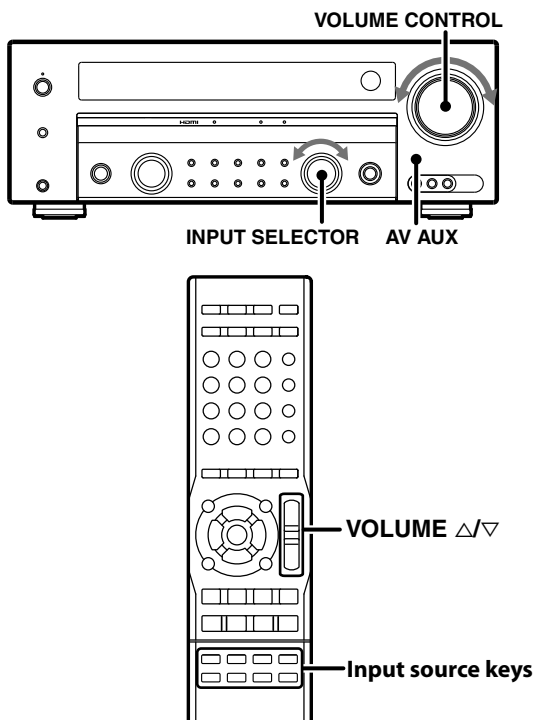

1 Select a source.

Use the Input source keys on the remote control unit to select a source.
Or use [INPUT SELECTOR] knob or [AV AUX] key on the main unit.

Example: Display when HDMI 1 input source is selected

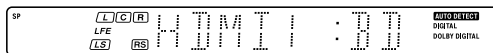

2 Start playback from the selected source.

3 Use [VOLUME Δ/▽] to adjust the volume.

4 Enjoy various surround effects.

You can enjoy a variety of listen modes. (See <Surround play using the listen mode> → 32.)
The surround effects can be fine tuned according to the selected input source. (See <Adjustments according to the playing source> → 39.)

- The AV AUX input cannot be selected with the [INPUT SELECTOR] knob of this unit. This input should be selected using the [AV AUX] on this unit or the [AV AUX] key on the remote control unit.

Monitoring the input source in the original sound (STRAIGHT DECODE mode)

The signal input from a source can be output directly without any sound field effect added to it.

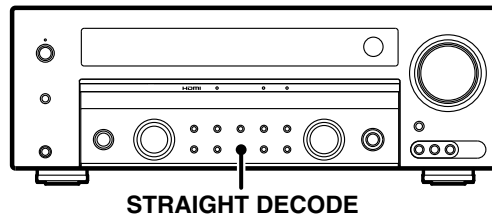

1 Select a source.

2 Start playback from the selected source.

3 Press [STRAIGHT DECODE].

When STRAIGHT DECODE mode is enabled, the listen mode is selected automatically according to the input signal.

"STRAIGHT DECODE" indicator lights up.

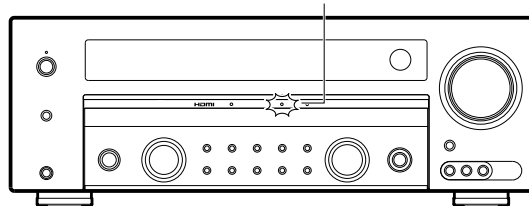

To cancel

Press [STRAIGHT DECODE].

STRAIGHT DECODE mode is also canceled when [LISTEN MODE] is operated.



- If the input signal uses a number of channels larger than the number of speakers in use, the signals are distributed automatically according to the available speakers.

Listening to music with PURE AUDIO MODE

PURE AUDIO MODE turns the display and analog video circuitry (other than HDMI) off to eliminate their effects on the audio circuitry. This mode thereby makes it possible to enjoy audio with higher quality and higher fidelity to the original sound.

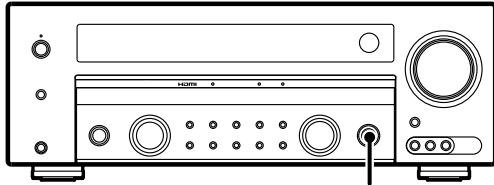

PURE AUDIO MODE

Playing music or movie

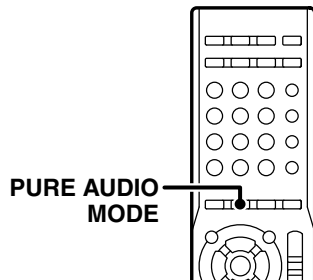

- 1** Select the music source you want to listen to.
- 2** Start playback from the selected source.
- 3** Press [PURE AUDIO MODE].

When PURE AUDIO MODE is enabled, the listen mode is selected automatically according to the input signal.

"PURE AUDIO MODE" indicator lights up, the display will be turned off, and no video signal is output to the TV monitor.

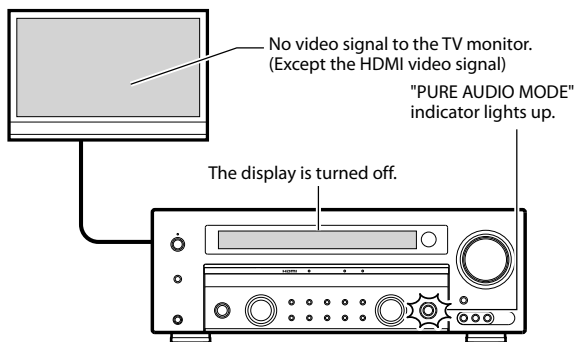

To cancel

Press [PURE AUDIO MODE].

PURE AUDIO MODE is also canceled when the [LISTEN MODE] or [STRAIGHT DECODE] key is operated.



- The video other than the HDMI input video cannot be monitored when PURE AUDIO MODE is selected.

Listen mode

The listen modes provided with this unit allow you to enjoy various surround effects with various video software. To enjoy the surround audio in the best condition, it is required to set up the speakers in advance.

6.1ch surround sound system (KRF-V6400D only)

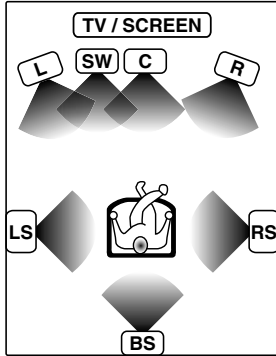

Listen mode

- Dolby Digital EX
- Dolby Pro Logic IIx (Movie, Music, Game)
- DTS-ES (Discrete, Matrix)
- Neo:6 (Cinema, Music)
- DSP mode (Arena, Jazz Club, Theater, Stadium, Disco)

5.1ch surround sound system

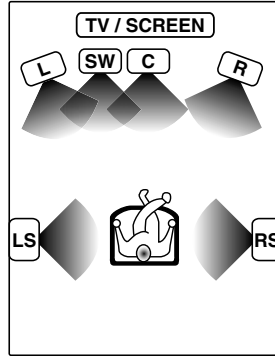

Listen mode

- Dolby Digital
- Dolby Pro Logic II (Movie, Music, Game)*1
- DTS
- DTS 96/24
- DSP mode (Arena, Jazz Club, Theater, Stadium, Disco)

*1 Available when the input signal has only 2 channels.

2ch stereo sound system

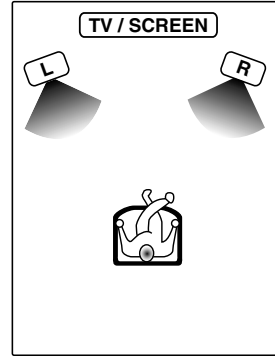

Listen mode

- Stereo
- DSP mode (Arena, Jazz Club, Theater, Stadium, Disco)

- L: Front Left speaker
- SW: Subwoofer
- C: Center speaker
- R: Front Right speaker
- LS: Surround Left speaker
- RS: Surround Right speaker
- BS: Surround Back speaker

Surround effects



- The following listen modes are available only for digital signal: Dolby Digital, Dolby Digital EX, DTS, DTS-ES and DTS 96/24

About indicators

Listen mode/Input signal format indicators

The indicator for the selected listen mode lights up.

The "DIGITAL" indicator also lights up when the input is a digital signal.

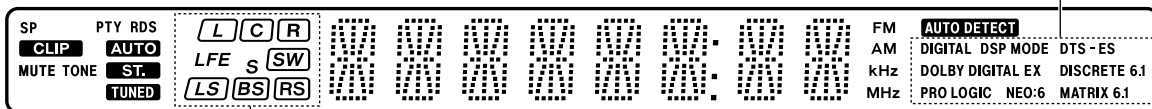

Input channel indicators

These indicators show the input channels used with the playing music and video.

- These indicators do not show the channels selected in the current listen mode.



- The "LFE" indicator lights when the LFE channel signal is input. The LFE level can be adjusted. (See <LFE (Low Frequency Effect) Level> → 25.)
- The "S" indicator lights when the surround signal consists of a single channel.

Surround play using the listen mode

Select the listen mode according to the source being played back.

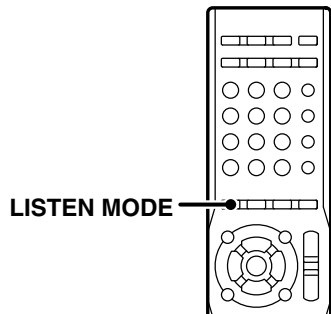
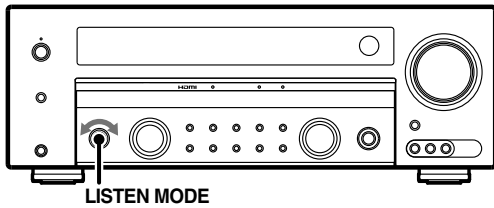

Surround effects

Preparations

- Turn the components to be used ON.
- Complete <Speaker setup>.
- Select the source you wish to play back with surround sound.
- Select the input mode → [28].
(When the input mode is set to "AUTO" (i.e. when the "AUTO DETECT" indicator is lit), the listen mode matching the input signal type and speaker setup are selected automatically. Noise may be produced when a DTS source is played by selecting the analog input.)

1 Start playing the selected source.

2 Use [LISTEN MODE] to select the listen mode.

Each press switches the listen mode.

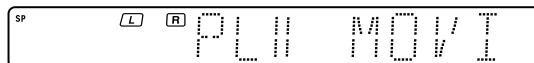

Checking the current input signal

The type and number of channels of the audio signal input can be checked.

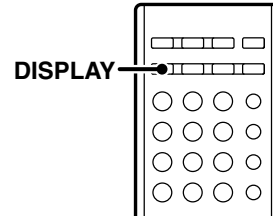

1 Press [DISPLAY].

The type of listen mode and its number of input channels are displayed for a few seconds.

Example: Display with DTS 5.1-channel input



- After displaying the type of listen mode and its number of input channels, the display will switch back to the input source name.
- This function is not available when in Tuner source.

Tuning into a radio station

This unit can store up to 40 stations in the memory and recall them by one-touch operation.

Radio stations can be classified into RDS (Radio Data System) stations and other stations. To listen to or store RDS stations in the preset memory see <Using RDS (Radio Data System)> → [34].

Be sure to connect antennas to receive radio broadcasts. (See <Connecting antennas> → [20].)

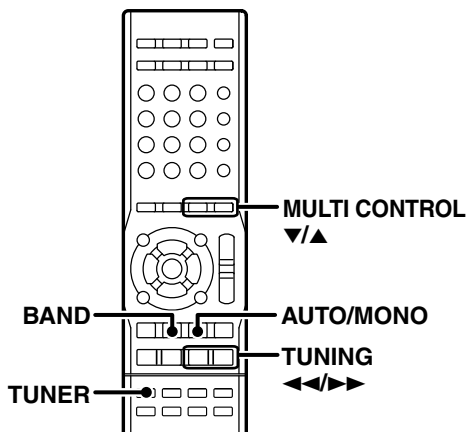
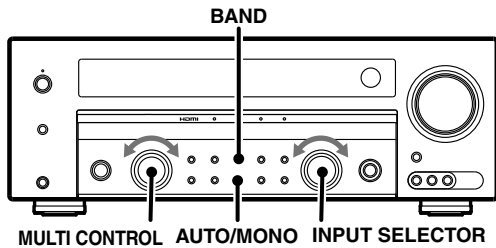

1 Set the input source to **TUNER**.

2 Use [**BAND**] to select the broadcast band.

Each press switches the band as follows:

- ① **FM**
- ② **AM**

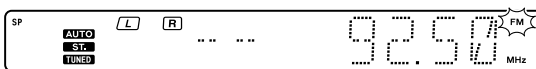

3 Use [**AUTO/MONO**] to select the tuning method.

Each press switches the tuning method as follows:

Setting	Operation	Indicator
Auto tuning	The next station is tuned automatically.	"AUTO" lit
Manual tuning	Select a station manually.	"AUTO" not lit

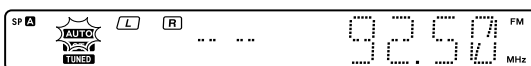

Normally, set to "AUTO" (auto tuning). If the radio waves are weak and there is a lot of interference, switch to manual tuning. (With manual tuning, stereo broadcasts will be received in monaural.)

4 Use [**TUNING <</>>**] to select the station.

"TUNED" lights when a broadcast is being received.

"ST" lights when a broadcast is being received in stereo.

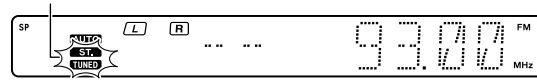

- [MULTI CONTROL ▼/▲] can also be use to select a station.

Using RDS (Radio Data System)

RDS is a system that transmits useful information (in the form of digital data) for FM broadcasts along with the broadcast signal. Tuners and receivers designed for RDS reception can extract the information from the broadcast signal for use with various functions, such as automatic display of the station name.

Before using a function utilizing the RDS, be sure to perform the RDS Auto Memory operation by referring to the description in <RDS Auto Memory>.

RDS functions:

RDS AUTO MEMORY function

Automatically selects and stores up to 40 RDS stations in the preset memory. If fewer than 40 RDS stations have been stored in the preset memory, regular FM stations will be stored in the remaining places.

PS (Program Service) Name Display

Automatically displays the station name transmitted by the RDS station.

PTY (Program TYPe) identification Search

Automatically tunes to a station that is currently broadcasting the specified program type (genre).

RT (Radio Text) function

Displays the radio text data transmitted by some RDS stations when you press [DISPLAY]. There is "NO RT" display if no text data is transmitted.

The "RDS" indicator lights up when an RDS broadcast (signal) is received.

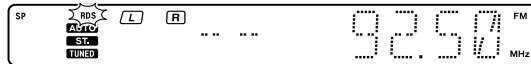

- Some functions and function names may differ for certain countries and areas.

RDS Auto Memory

This function automatically stores up to 40 RDS stations in the preset memory. In order to use the PTY function, the RDS stations must be stored in the preset memory using the RDS AUTO MEMORY function.

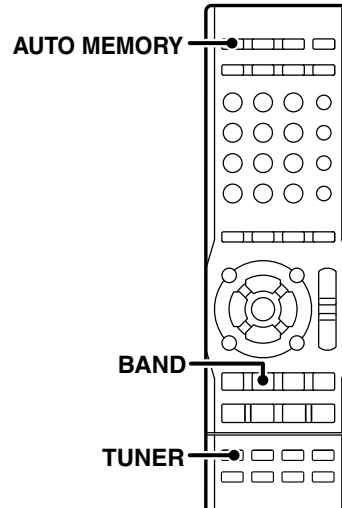

- 1 Press [TUNER] to select the tuner.
- 2 Press [BAND] to set the broadcast band to "FM".
- 3 Press [AUTO MEMORY] to start auto memory.

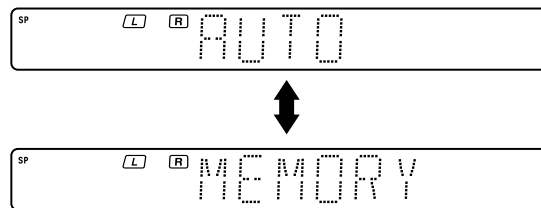

After a few minutes, up to 40 RDS stations are preset in order from channel "01".

Stations already stored in the preset memory may be replaced by RDS stations. (i.e., If the RDS AUTO MEMORY function detects 15 RDS stations, the stations currently preset at numbers 01-15 will be replaced by the RDS stations.)

Presetting radio stations manually

The RDS auto memory function assigns preset numbers to RDS stations starting from preset number "1". Therefore, be sure to execute the RDS auto memory function before using the following operations to manually store AM stations and other FM stations, and RDS stations.
See <RDS Auto Memory>.

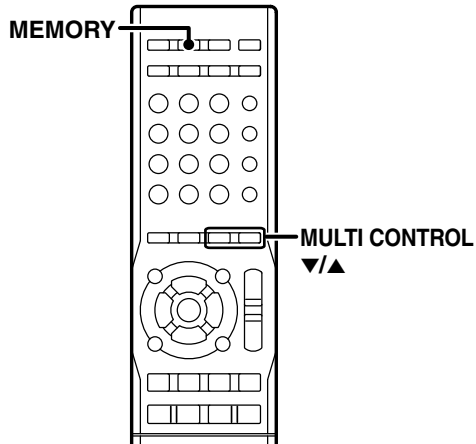

- 1** Tune in the station you want to store.
- 2** Press [MEMORY] while receiving the station.

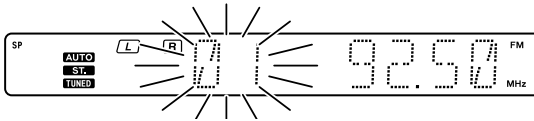

Proceed to step 3 within 20 seconds.
If more than 20 seconds elapse, press [MEMORY] again.

- 3** Use [MULTI CONTROL ▼/▲] to select one of the station presets (1 – 40).
- 4** Press [MEMORY] to confirm the setting.

Repeat steps 1 to 4 to store as many stations as necessary.
If you store a station at a previously used preset, the previous station will be replaced by the new one.

Receiving preset stations

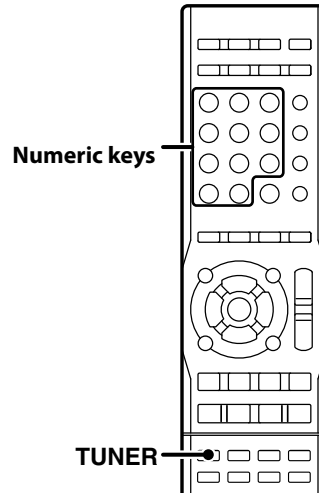

- 1** Press [TUNER] to select tuner as the source.
- 2** Enter the number of the preset station you want to receive (up to "40" preset numbers).

Press the Numeric keys in the following order:

For preset No.15: [+10] and [5]

For preset No.20: [+10], [+10] and [0]

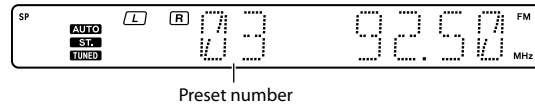

Preset number



- If you make a mistake entering a two digit number, press [+10] repeatedly to return to the original display and start again.

Receiving preset stations in order (P.CALL)

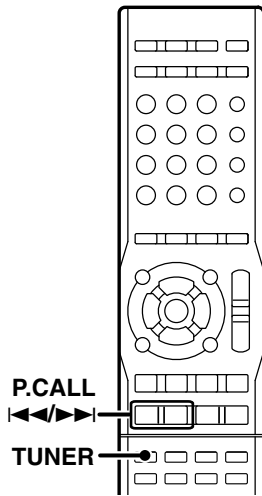

- 1** Press [TUNER] to select tuner as the source.
- 2** Use [P.CALL <=>] to select the desired station.

Each time you press the key, another preset station is received in order.

Holding down the [P.CALL <=>] lets you skip through the presets, receiving each preset station at 0.5 second intervals.

Tuning by program type (PTY search)

This function lets you set the tuner to automatically search for stations which are currently broadcasting the type of program (genre) you want to listen to.

Under certain receiving conditions, it may take more than 1 minute to complete the search.

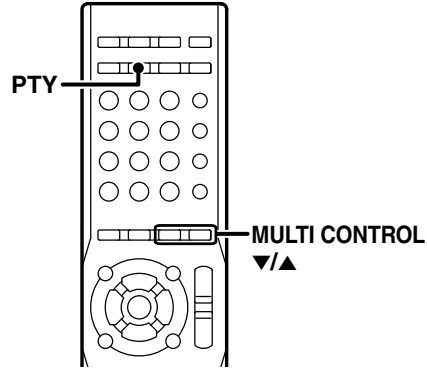

Preparations

- Execute the RDS auto memory procedure.
- Set the broadcast band to FM.
- Tune to an RDS station.

- 1** Press [PTY] to activate the PTY search mode.



When an RDS broadcast is received, the program type is shown on the display. If no PTY data is available, or if the station is not an RDS station, "NONE" is displayed.

- 2** While the "PTY" indicator is lit, use [MULTI CONTROL <=>] to select the program type of your choice.

Program type	Display	Program type	Display
Pop Music	"POP M"	Weather	"WEATHER"
Rock Music	"ROCK M"	Finance	"FINANCE"
Easy Music	"EASY M"	Children's Program	"CHILDREN"
Light Classical Music	"LIGHT M"	Social Affairs	"SOCIAL"
Serious Classical Music	"CLASSICS"	Religion	"RELIGION"
Other Music	"OTHER M"	Phone In	"PHONE IN"
News	"NEWS"	Travel	"TRAVEL"
Current Affairs	"AFFAIRS"	Leisure	"LEISURE"
Information	"INFO"	Jazz Music	"JAZZ"
Sport	"SPORT"	Country Music	"COUNTRY"
Education	"EDUCATE"	National Music	"NATION M"
Drama	"DRAMA"	Oldies Music	"OLDIES"
Culture	"CULTURE"	Folk Music	"FOLK M"
Science	"SCIENCE"	Documentary	"DOCUMENT"
Varied Speech	"VARIED"		

Using the **DISPLAY** key

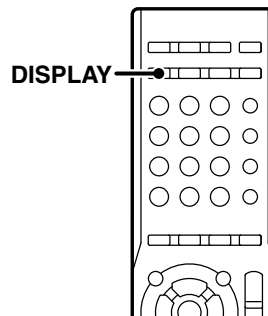

3 Press [PTY] to start searching.

Example: Searching for a Rock Music broadcast.

Display while searching.

Blinks



Display when a station is received.

Goes out



Station name display

No sound is heard while "PTY" is blinking.

If the desired program type cannot be found, "NO PROG" is displayed, then after several seconds the display returns to the original display.

To select another program type

Repeat steps 1, 2 and 3.

Pressing [DISPLAY] changes the contents of the display.

Each press switches the display mode as follows:

- ① **PS (Program Service) name display**
- ② **RT (Radio Text) display**
- ③ **Frequency display**

① PS (Program Service) name display

The station name is displayed automatically when an RDS broadcast is received.

If no PS data was sent, "NO PS" is displayed.



② RT (Radio Text) display

Text data accompanying the RDS broadcast scrolls across the display. "NO RT" is displayed if the current RDS station does not provide RT data.



③ Frequency display

Displays the frequency of the current station.

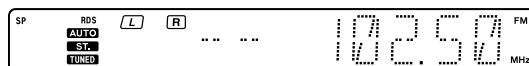

Adjusting the sound

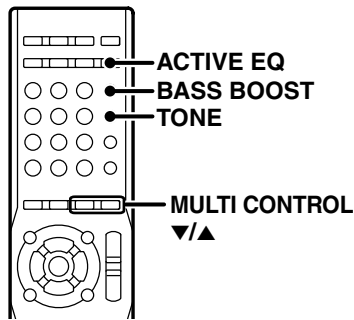
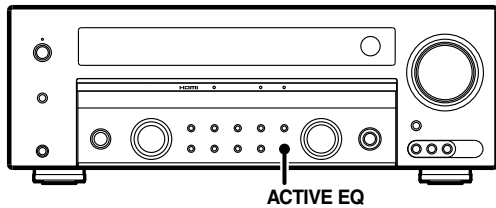

ACTIVE EQ mode

The optimum acoustic field effect can be selected according to the purpose of playback.

Press [ACTIVE EQ].

Each press switches the mode as follows:

Display	Setting
"ACTIVE EQ MUSIC"	Effective when listening to music.
"ACTIVE EQ CINEMA"	Effective when watching a movie.
"ACTIVE EQ GAME"	Effective when playing a game.
"ACTIVE EQ OFF"	Active EQ function is off.

"ACTIVE EQ" indicator lights up.

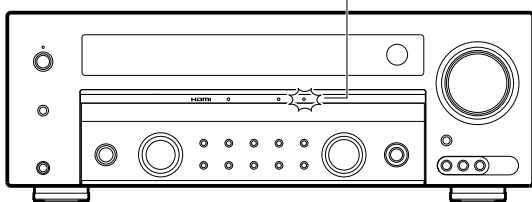

Sound adjustment

Bass Boost

The Bass Boost can be adjusted when the input signal is a PCM or analog signal and the listen mode of this unit is set to "STEREO", and also ACTIVE EQ mode is set to "OFF".

Press [BASS BOOST].

Press the key once to select the maximum (+10) low frequency emphasis setting.

TONE will automatically be turned ON.

To cancel

Press [BASS BOOST] again.

Adjusting the Tone

The tone level can be adjusted when the input signal is a PCM or analog signal and the listen mode of this unit is set to "STEREO", and also ACTIVE EQ mode is set to "OFF".

1 Press [TONE].

2 Select whether or not the tone level is to be adjusted.

Use [MULTI CONTROL ▼/▲] to select "TONE ON" or "TONE OFF".

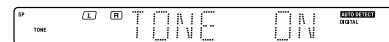

[TONE]

Display	Setting
"TONE ON"	The tone level can be adjusted. Go to step 3 after setting.
"TONE OFF"	The tone level is not adjusted.

3 Adjust the level of "BASS" (low frequencies).

Use [MULTI CONTROL ▼/▲] to adjust the level.



[TONE]

The level is adjusted from -10 to +10.

4 Adjust the level of "TREB" (high frequencies).

Use [MULTI CONTROL ▼/▲] to adjust the level.



[TONE]

The level is adjusted from -10 to +10.

Adjustments according to the playing source

The audio can be adjusted as desired according to the source being played.

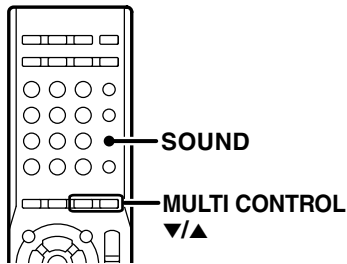
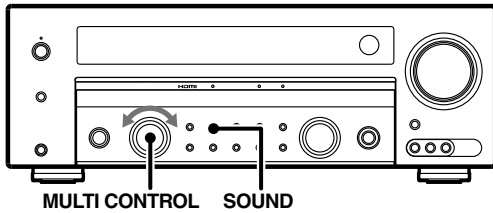

1 Press [SOUND] to enter the surround adjustment mode.

Each press switches the mode as follows.
Note that some items are not displayed depending on speaker settings and listen mode.

Display	Setting item	Range	
"C"	Center speaker level	-10 – +10dB	
"RS"	Surround Right speaker level	-10 – +10dB	
"BS"	Surround Back speaker level	-10 – +10dB	*1
"LS"	Surround Left speaker level	-10 – +10dB	
"SW"	Subwoofer level	-10 – +10dB	
"INPUT"	Input level	-6, -3, 0	*2
"NIGHT"	Midnight mode	"ON", "OFF"	*3
"PANORAMA"	Panorama mode	"ON", "OFF"	
"DIMENSION"	Dimension		*4
"CENTER WIDTH"	Center Width		
"CENTER IMAGE"	Center Image	0.0 – 1.0	*5
Input source name	Exit the adjustment mode.		

*1 The adjustment is only temporary for the current input selection. The value will return automatically to the original setup value when the power is turned on/off or when the input selection is changed.

*2 Analog source only

*3 Dolby Digital and DTS mode only

*4 Pro Logic II Music mode and Pro Logic IIx Music mode only

*5 Neo:6 Music mode only

2 Use [MULTI CONTROL ▼/▲] to adjust the desired item.

For detailed adjustment method, see the explanation of each item.

To exit the sound adjustment mode

Press [SOUND].

Speaker level adjustment

The output level from the desired speaker channels can be fine adjusted according to the properties of each source. The adjustment is only temporary for the current input selection. The value will return automatically to the original setup value when the power is turned on/off or when the input selection is changed.

1 Press [SOUND] repeatedly to select the speaker to adjust ("C", "RS", "BS", "LS" or "SW").

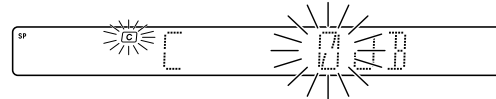

2 Use [MULTI CONTROL ▼/▲] to adjust the level.

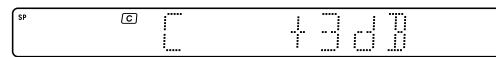

3 Repeat steps 1 and 2 to adjust the level of other speakers.

Input level adjustment

● Analog source only

If the input level of an analog source signal is too high, the CLIP indicator will light to indicate. Adjust the input level.



1 Press [SOUND] repeatedly to select "INPUT".



2 Use [MULTI CONTROL ▼/▲] to adjust the input level.

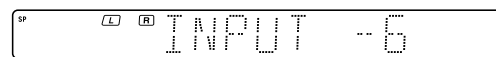

Adjustments according to the playing source

Midnight mode

- Dolby Digital and DTS mode only

When watching movies at night, you might not be able to raise the volume as loud as normal. Midnight mode compresses the dynamic range of previously specified heavy sound passage of the Dolby Digital and DTS mode sound track (like scenes with sudden increases in volume) to minimize the difference in volume between the scenes with heavy sound passage and scenes with normal sound passage. This makes it easy to hear all of the sound track, even when listening at low volumes.

- 1 Press [SOUND] repeatedly to select "NIGHT".



- 2 Use [MULTI CONTROL ▼/▲] to select "ON" or "OFF".

Display	Setting
"NIGHT ON"	Midnight mode is on.
"NIGHT OFF"	Midnight mode is off.

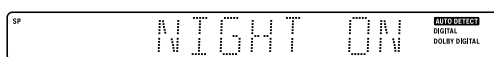

- Some Dolby Digital or DTS software may not be compatible with the Midnight mode.

Sound adjustment

Panorama mode

- Pro Logic IIx Music and Pro Logic II Music mode only

The acoustic field of the front channels can be expanded till the field of surround channels, which makes it possible to create sound expansion in the front of the listener.

- 1 Press [SOUND] repeatedly to select "PANORAMA".



- 2 Use [MULTI CONTROL ▼/▲] to select "ON" or "OFF".

Display	Setting
"PANORAMA ON"	PANORAMA mode is on.
"PANORAMA OFF"	PANORAMA mode is off.

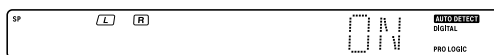

Dimension

- Pro Logic IIx Music and Pro Logic II Music mode only

The center of the acoustic field can be moved toward the front or rear.

- 1 Press [SOUND] repeatedly to select "DIMENSION".

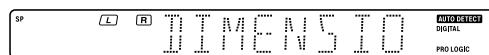

- 2 Use [MULTI CONTROL ▼/▲] to move the acoustic field to the front or rear.

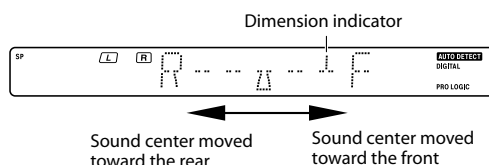

Center width

- Pro Logic IIx Music and Pro Logic II Music mode only

The center channel audio can be distributed to the front left and right speakers to enhance the width of the sound in front of the listener.

- 1 Press [SOUND] repeatedly to select "CENTER WIDTH".

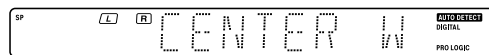

- 2 Use [MULTI CONTROL ▼/▲] to move the acoustic field to the left or right.

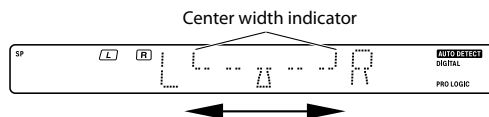

When the indicator extends to the left and right wider, more part of the center channel audio is distributed to the front left and right speakers.



- This setup is not available when the center speaker setup is "OFF".

Center image

- DTS Neo:6 Music mode only

The output level of the center speaker can be adjusted.

- 1** Press [SOUND] repeatedly to select "CENTER IMAGE".

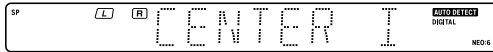

- 2** Use [MULTI CONTROL ▼/▲] to adjust the center speaker output.



More part of the center channel audio is distributed to the front left and right speakers as the number increases.



- This setup is not available when the center speaker setup is "OFF".

Convenient functions

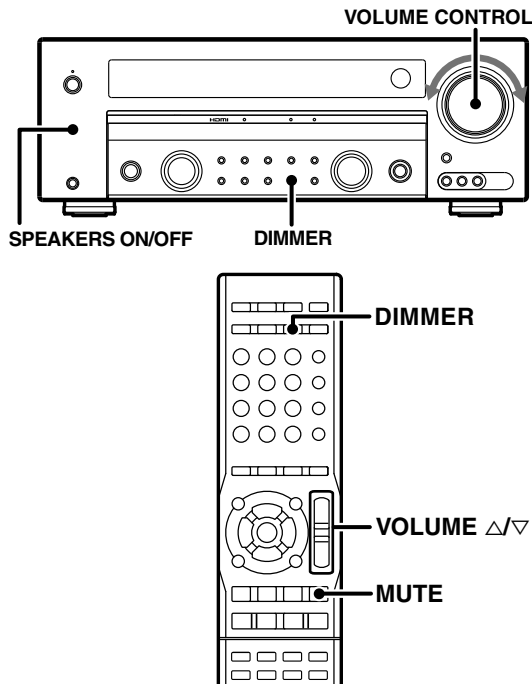

Display dimmer adjustment

The dimmer function lets you select the brightness of the display and indicators of this unit. You might find this useful if you darken your room to watch movies or listen to music.

Press [DIMMER].

The brightness of the display changes among the three available settings. Select the brightness level you find most pleasing.

- ① Slightly dark
- ② Dark
- ③ Normal



The brightness of the LED indicators changes in 2 levels.

Convenient functions

Listening with headphones

1 Press [SPEAKERS ON/OFF] so that the speaker indicator goes off.

Make sure the "SP" indicator is turned off.

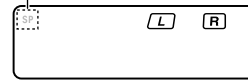

If you turn off all of the speakers when in surround mode, the surround mode will be canceled as well, resulting in stereo playback.

2 Connect headphones to the [PHONES] jack.

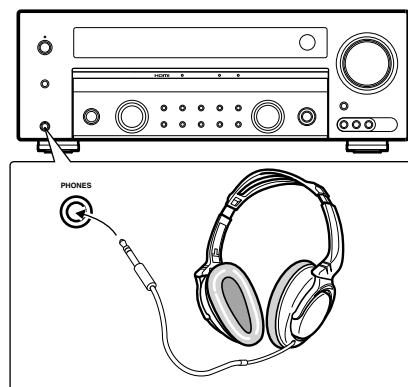

3 Adjust volume.

Muting the sound

Press [MUTE].

"MUTE" indicator blinks.

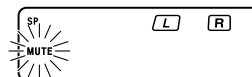

To cancel

Press [MUTE] again so that the "MUTE" indicator goes off.

MUTE can also be deactivated by adjusting volume.

Remote control operations for Kenwood DVD players

The remote control of this unit can control Kenwood DVD players directly without using the remote control supplied with the DVD player.

Compatible DVD player models

DV-4900, DV-4070B, DV-2070, DV-203, DVF-9010, DVF-K7010, DVF-5010, DVF-R9030, DVF-R7030, DVF-3530, DV-402, DV-5900, DV-5700, DVF-R9050, DVF-J6050, DV-505, DV-503, DV-502, DVF-3550, DVF-3050, DVF-R4050, DVF-605, DV-6050, DVF-R5060, DVF-3060, DVF-3060K, DV-705, DVF-R5070, DVF-3070, DVF-3080, DVF-N7080, DVF-8100, DVF-3200, DVF-3250, DVF-3300, DVF-3400, DVF-5400, DVF-3500 and DVF-5500.

How to operate the DVD player with the remote control

- 1** Press [DVD] to turn the DVD player on.
- 2** Press [DVD] to operate the functions of the DVD player.
Pressing [DVD] allows you to control the connected Kenwood DVD player with this remote control unit.
- 3** Press each key for DVD player operation. Refer to the operation manual of the DVD players for the detailed operating instructions.
(To return to the receiver operation mode, press other Input source key.)

DVD player operation keys

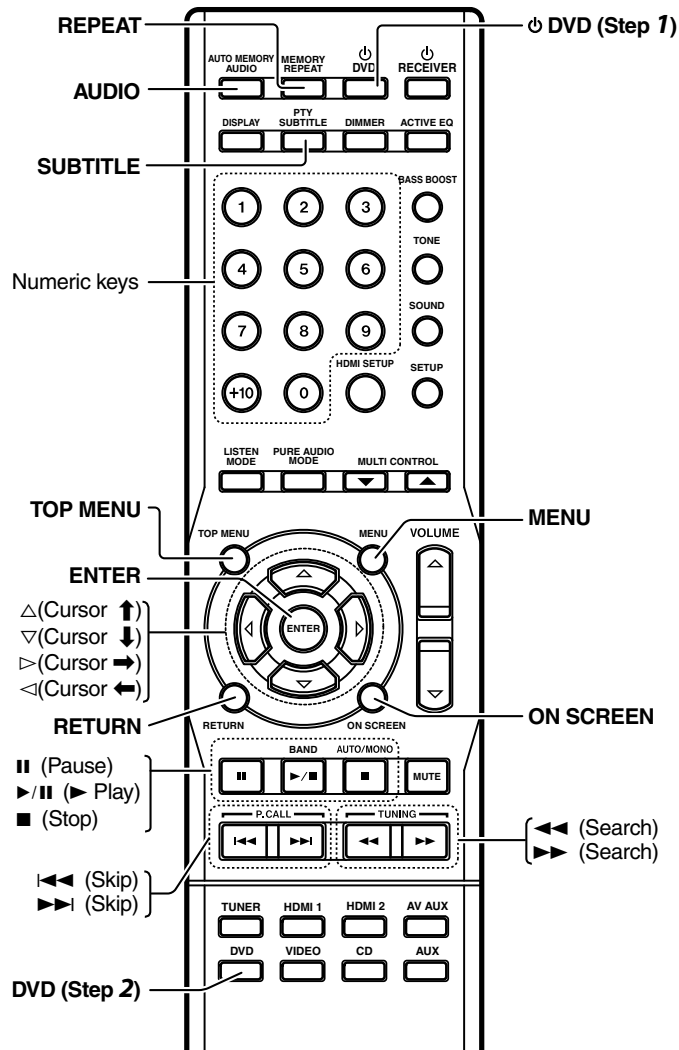

Convenient functions

Troubleshooting

Amplifier

Symptom	Cause	Remedy	
No sound from the speakers.	The speaker cords are disconnected.	Connect it properly referring to <Connecting speakers>. → 18 → 19	
	VOLUME is set to the minimum position.	Adjust the volume to a proper level.	
	MUTE is ON.	Turn OFF the MUTE. → 42	
	The SPEAKERS switches are set to OFF.	Set the SPEAKERS switch to ON. → 28	
	The input source selection is incorrect.	Select the input source you want to play.	
	The input mode is not set properly.	Select the optimum input mode by referring to <Selecting the input mode>. → 28	
	Audio signal may not be output depending on the connecting method and connected components.	Refer to the instruction manuals that come with the connected components.	
The standby indicator blinks and sound is not output.	Speaker cords are short-circuited.	Turn the power off, eliminate the short-circuiting, then turn on the power again. If the standby indicator still blinks after eliminating the short-circuiting, there may be an internal defect. Switch it off, unplug the power cord and call for service.	
Sound is not output from one of the speakers.	The speaker cord is disconnected.	Connect it properly referring to <Connecting speakers>. → 18 → 19	
	The speaker is not set up correctly.	Set it up properly referring to <Speaker setup>. After setting, confirm that the test tone is output. → 22 → 23 → 24	
	Some speakers do not output audio depending on the listen mode.		
Sound is not output from the surround speakers and/or the center speaker, or their sound is very soft.	The surround speaker cords and/or the center speaker cord is disconnected.	Connect it properly referring to <Connecting speakers>. → 18 → 19	
The audio cannot be played in the desired signal format (Dolby Digital or DTS).	Digital connection is necessary to play the Dolby Digital, or DTS input signal in the input signal format.	Confirm that the input signal is connected to the digital input or HDMI input terminal by referring to <Connections>. → 11 → 21	
	The player component is not set for digital output.	Confirm the audio output setup of the player component by referring to its instruction manual.	
When playing a Dolby Digital or DTS source, the sound is cut off soon after it starts.	There are many possible causes for this problem, depending on the player used.	Set the input mode to "MANUAL" before starting playback of the Dolby Digital or DTS source. → 28	
No sound is produced during playback from a DVD player.	The input mode is set to "MANUAL".	Press the [INPUT MODE] key to select to "AUTO". → 28	
A video source cannot be recorded normally.	The software is copy-guarded.	Copy-guarded video software cannot be recorded.	
The audio of a digital broadcast cannot be switched.	The audio of certain broadcasts cannot be switched with this unit.	Switch the audio on the digital tuner.	
The video is not output or is disturbed.	The video component is not connected properly.	Connect it properly by referring to <Connections>. → 11 → 21 If the video component is connected to this unit through HDMI connection, the digital video signal input from the HDMI input terminals is output only at the HDMI monitor output terminal.	
	Video signal may not be output depending on the connecting method and connected components.	Refer to the instruction manuals that come with the connected components.	
	The input of the TV monitor is not set properly.	Confirm the input setup of the TV monitor.	
	A non NTSC/PAL video signal is input.	Set the video setup of the video player component to NTSC/PAL. Refer to the instruction manual of the video player component.	
	PURE AUDIO MODE is set to "ON".	If PURE AUDIO MODE is set to "ON", the video circuitry is switched off and only the input HDMI video can be output. Set PURE AUDIO MODE to "OFF". → 30	
	Display is turned off.	PURE AUDIO MODE is on.	While the PURE AUDIO MODE is on, the display is turned off. Turn off the PURE AUDIO MODE. → 30

Tuner

Symptom	Cause	Remedy
Radio stations cannot be received.	No antenna is connected.	Connect an antenna. → 20
	The broadcast band is not set properly.	Set the broadcast band properly. → 33
	The frequency of the desired station is not tuned.	Tune in the frequency of the desired station. → 33
Interference	Noise due to ignition of an automobile.	Install the outdoor antenna away from the road.
	Noise due to interference from an electric appliance.	Turn off the power to the appliance.
	Noise due to a nearby TV set.	Install the unit farther away from the TV.

Remote control unit

Symptom	Cause	Remedy
Remote control operation is not possible.	The remote control is not set to the source operation mode you wish to control.	Press the appropriate Input Source key to select the source you wish to control.
	The remote control has not been changed to the operation mode for the Kenwood DVD player you wish to control.	Press the [DVD] key to activate the operation mode for the component you want to control before operation. → 43
	Batteries are exhausted.	Replace with new batteries. → 9
	The remote control unit is too far away from the main system, controlling angle is too large, or there is an obstacle between this unit and the remote.	Operate the remote control unit within the controllable range. → 9
	There is an obstacle between this unit and the remote control unit.	Remove the obstacle.

Resetting the unit

If the unit is completely inoperable, the display is not normal or a problem cannot be solved even after checking the list in <Troubleshooting>, it is required to reset the the unit.

While holding down [⏻] key on the unit, unplug the power cord and plug it back in.

- Please note that resetting the unit will clear the contents of the memory and return the unit to the state it was in when it left the factory.

Glossary

Dolby Digital

Digital multi-channel audio standard developed by Dolby Laboratories. It supports transmission and recording of high-quality digital audio signals from monaural up to 5.1 channels using an amount of data that is a fraction of the PCM audio format. The main features of Dolby Digital include:

- Downmixing optimized for monaural, stereo and Pro Logic configurations as well as for playback of 6.1-channel audio.
- Transfer of information related to the dynamic range and the conversation level adjustment.
- Wide range of operating bit rates.

Dolby Digital EX/Dolby EX

These extensions of Dolby Digital add the surround back channel to the Dolby Digital channels to deliver a surround effect with enhanced presence and listener envelopment.

Dolby Pro Logic II

This is a matrix decoding technology developed by Dolby Laboratories. It generates 5-channel surround audio with rich feeling of presence from any stereo source, delivering an excellent multidimensional sound field effect even from an ordinary stereo music content including CD music. It offers three modes including the Movie mode optimized for movie playback, the Music mode for music playback and the Game mode for game play.

Dolby Pro Logic IIx

Matrix decoding technology developed by improving Dolby Pro Logic II. It accepts any stereo or 5.1-channel audio input and generates 7.1-channel surround audio with a more natural, smoother surround sound field. It also offers three modes optimized for each source content, including the Movie mode for movie playback, the Music mode for music playback and the Game mode for game play.

DTS Digital Surround

Digital surround format developed by DTS Corporation. It features low compression rate and high sound quality, and is capable of reproducing max. 5.1 channels.

DTS-ES

This is a 6.1-channel audio technology developed by adding the surround back channel to DTS Digital Surround.

The signal of this format can also be played on existing DTS 5.1-channel components. DTS-ES consists of two types, which are DTS ES Matrix and DTS-ES Discrete 6.1.

DTS-ES Matrix

With this format, the audio for the surround back channel added to the DTS 5.1-channel audio is allocated to the two surround channels during recording. When the signal is decoded, the audio for the surround back channel is restored from the surround channels to deliver the 6.1-channel audio.

DTS-ES Discrete

With this format, the audio for the surround back channel added to the DTS 5.1-channel audio is recorded in an independent channel.

DTS Neo:6

This is a matrix decoding technology developed by DTS Corporation, capable of delivering max. 6.1 channels from any 2-channel source. It includes two modes, including the DTS Neo:6 CINEMA mode optimized for movie playback and the DTS Neo:6 MUSIC mode optimized for music playback.

DTS 96/24

5.1-channel digital audio format developed as an evolution of the DTS 5.1-channel format. It enables high-quality playback with 96 kHz sampling frequency and 24-bit quantization (the signal of this format can also be reproduced on existing DTS 5.1-channel player components).

PCM

PCM (Pulse Code Modulation) is a method of encoding audio signal digitally without compression.

DSP mode

The DSP mode produces the feeling of presence by using the DSP (Digital Signal Processor) to create reverberation, without spoiling the sound quality of the original signal. The DSP mode is particularly effective when used with stereo program sources. It offers 5 different mode (Arena, Jazz club, Theater, Stadium and Disco).

HDMI

HDMI (High-Definition Multimedia Interface) is a standard developed based on DVI (Digital Visual Interface) and features the capability of transferring both non-compressed digital video and multi-channel digital audio through a single cable.

This unit is compatible with the HDMI optional functions listed below.

- Deep Color
Video signals with a larger number of bits per color component than ordinary 8 bits, such as the 10-bit and 12-bit signals can be transferred to achieve richer expression of gradations.
- x.v.Color
A larger variety of colors, or about 180% more colors than the number of colors of sRGB color space, can be reproduced.
- Lip Sync
The video and audio are synchronized in the monitor by detecting the delay of monitored video automatically.



DVI

DVI (Digital Visual Interface) is the standard for connection between PC and display.

HDCP

HDCP (High-bandwidth Digital Contents Protection) is copyright protection technology for prevention of illegal duplication of video contents. It is used in encryption of digital interfaces such as DVI and HDMI.

Specifications

AUDIO section

Rated output power during STEREO operation
 (63 Hz – 20 kHz, 0.7% T.H.D., at 6 Ω) 100 W + 100 W

Effective output power during STEREO operation
 RMS (1 kHz, 10% T.H.D., at 6 Ω) 130 W + 130 W

Effective power output during SURROUND operation

FRONT
 (1 kHz, 0.7 % T.H.D. at 6 Ω one channel driven) 100 W + 100 W
 (1 kHz, 10 % T.H.D. at 6 Ω one channel driven) 130 W + 130 W

CENTER
 (1 kHz, 0.7 % T.H.D. at 6 Ω one channel driven) 100 W
 (1 kHz, 10 % T.H.D. at 6 Ω one channel driven) 130 W

SURROUND
 (1 kHz, 0.7 % T.H.D. at 6 Ω one channel driven) 100 W + 100 W
 (1 kHz, 10 % T.H.D. at 6 Ω one channel driven) 130 W + 130 W

SURROUND BACK (KRF-V6400D only)
 (1 kHz, 0.7 % T.H.D. at 6 Ω one channel driven) 100 W
 (1 kHz, 10 % T.H.D. at 6 Ω one channel driven) 130 W

SUBWOOFER (KRF-V5450D only)
 (100 Hz, 0.7 % T.H.D. at 6 Ω one channel driven) 100 W
 (100 Hz, 10 % T.H.D. at 6 Ω one channel driven) 130 W

Total harmonic distortion 0.05 % (1 kHz, 50 W, 6 Ω)

Frequency response (IHF'66)
 DVD, VIDEO, CD, AUX 10 Hz – 70 kHz, +0 dB – -3.0 dB

Signal to noise ratio (IHF'66)
 DVD, VIDEO, CD, AUX 100 dB

Input sensitivity / impedance
 DVD, VIDEO, CD, AUX 550 mV / 66 kΩ
 AV AUX 550 mV / 33 kΩ

Output level / impedance
 PRE OUT (SUBWOOFER) 2.0 V / 300 Ω

Tone control
 BASS ±10 dB (at 100 Hz)
 TREBLE ±10 dB (at 10 kHz)

DIGITAL AUDIO section

Input terminal
 Optical CD, VIDEO
 Coaxial DVD

VIDEO section

Video format PAL / NTSC

VIDEO input sensitivity / impedance (DVD, VIDEO, AV AUX)
 Composite 1 Vp-p / 75 Ω

VIDEO output level / impedance (MONITOR)
 Composite 1 Vp-p / 75 Ω

HDMI section

HDMI input terminal HDMI 1, HDMI 2
 HDMI output terminal MONITOR OUT

FM tuner section

Tuning frequency range 87.5 MHz – 108.0 MHz

AM tuner section

Tuning frequency range 531 kHz – 1,602 kHz

General

Power consumption 240 W
 Standby power consumption (HDMI Link : Off) less than 0.7 W

Dimensions
 W: 440 mm (17-5/16")
 H: 159 mm (6-1/4")
 KRF-V6400D D: 372 mm (14-5/8")
 KRF-V5450D D: 362 mm (14-1/4")

Weight (net) 9.5 kg (20.9 lb)



- Kenwood follows a policy of continuous advancements in development. For this reason specifications may be changed without notice.
- The full performance may not be exhibited in an extremely cold location (under a water-freezing temperature).

KENWOOD

For your records

Record the serial number, found on the back of the unit, in the spaces designated on the warranty card, and in the space provided below. Refer to the model and serial numbers whenever you call upon your dealer for information or service on this product.

Model _____ Serial Number _____