

# KENWOOD

## DNX7280BT DNX5280BT DNX4280BT DNX5580BT

GPS NAVIGATION SYSTEM  
**Quick Start Guide**

Kenwood Corporation



## About The Quick Start Guide

This Quick Start Guide explains the basic functions of this unit. For functions not covered in this guide, refer to the Instruction Manual (PDF file) contained in the included CD-ROM "Instruction Manual".

To refer to the Instruction Manual contained in the CD-ROM, a PC loaded with Microsoft® Windows XP/ Vista/7 or Mac OS X® 10.4 or later is required in addition to Adobe® Reader™ 7.1 or Adobe® Acrobat® 7.1 or later.

The Instruction Manual is subject to change for modification of specifications and so forth. You can download the latest version of the Instruction Manual from [www.kenwood.com/cs/ce/](http://www.kenwood.com/cs/ce/).

### NOTE

- The panels shown in this guide are examples used to provide clear explanations of the operations. For this reason, they may be different from the actual panels.
- In this manual, each model name is abbreviated as follows.
  - DNX7280BT: **DNX7**
  - DNX5280BT and DNX5580BT: **DNX5**
  - DNX4280BT: **DNX4**
- If above icons are shown, read the article applicable to the unit you use.
- In operation procedures, bracket shape indicates the key or button you should control.
  - < >: indicates the name of panel buttons.
  - [ ]: indicates the name of touch keys.

## Contents

<b>About The Quick Start Guide</b>	<b>2</b>
<b>Contents</b>	<b>2</b>
<b>Precautions</b>	<b>3</b>
▲WARNING _____	3
Cleaning The Unit _____	4
How To Reset Your Unit _____	4
<b>Safety Precautions and Important Information</b>	<b>5</b>
▲WARNINGS _____	5
▲CAUTIONS _____	5
IMPORTANT INFORMATION _____	5
<b>First Step</b>	<b>6</b>
<b>Basic Operations</b>	<b>8</b>
Functions Of The Buttons On The Front Panel _____	8
Common Operations _____	12
Detaching The Front Panel <b>DNX7</b> <b>DNX5</b> _____	13
<b>How To Use The Navigation System</b>	<b>14</b>
Other Features _____	16
<b>How To Play Music</b>	<b>17</b>
<b>How To Play Movie/Picture</b>	<b>19</b>
<b>How To Listen To The Radio</b>	<b>20</b>
<b>How To Make A Phone Call</b>	<b>21</b>
<b>Installation Procedure</b>	<b>23</b>
Before Installation _____	23
Installation Procedure _____	24
Removing Procedure _____	26
Connection _____	28
About This Unit _____	32

## Precautions

### ⚠ WARNING

#### To prevent injury or fire, take the following precautions:

- To prevent a short circuit, never put or leave any metallic objects (such as coins or metal tools) inside the unit.
- Do not watch or fix your eyes on the unit's display when you are driving for any extended period.
- If you experience problems during installation, consult your Kenwood dealer.

#### Precautions on using this unit

- When you purchase optional accessories, check with your Kenwood dealer to make sure that they work with your model and in your area.
- You can select language to display menus, audio file tags, etc. See **Language setup (P.68)** in the Instruction Manual.
- The Radio Data System or Radio Broadcast Data System feature won't work where the service is not supported by any broadcasting station.

#### Precautions on battery

- Keep battery out of reach of children and in original package until ready to use. Dispose of used batteries promptly. If swallowed contact physician immediately.
- Do not leave the battery near fire or under direct sunlight. A fire, explosion or excessive heat generation may result.
- Do not set the remote control in hot places such as on the dashboard.
- Danger of explosion if Lithium battery is incorrectly replaced. Replace only with the same or equivalent type.

#### Protecting the monitor

To protect the monitor from damage, do not operate the monitor using a ballpoint pen or similar tool with the sharp tip.

#### Lens fogging

When you turn on the car heater in cold weather, dew or condensation may form on the lens in the disc player of the unit. Called lens fogging, this condensation on the lens may not allow discs to play. In such a situation, remove the disc and wait for the condensation to evaporate. If the unit still does not operate normally after a while, consult your Kenwood dealer.

#### Precautions on handling discs

- Do not touch the recording surface of the disc.
- Do not stick tape etc. on the disc, or use a disc with tape stuck on it.
- Do not use disc type accessories.
- Clean from the center of the disc and move outward.
- When removing discs from this unit, pull them out horizontally.
- If the disc center hole or outside rim has burrs, use the disc only after removing the burrs with a ballpoint pen etc.
- Discs that are not round cannot be used.

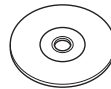

- 8-cm (3 inch) discs cannot be used.
- Discs with coloring on the recording surface or discs that are dirty cannot be used.
- This unit can only play the CDs with



This unit may not correctly play discs which do not have the mark.

- You cannot play a disc that has not been finalized. (For the finalization process see your writing software, and your recorder instruction manual.)

## Acquiring GPS signals

The first time you turn on this unit, you must wait while the system acquires satellite signals for the first time. This process could take up to several minutes. Make sure your vehicle is outdoors in an open area away from tall buildings and trees for fastest acquisition. After the system acquires satellites for the first time, it will acquire satellites quickly each time thereafter.

## About the front panel **DNX7**

When removing the product from the box or installing it, the front panel may be positioned at the angle shown in (Fig. 1). This is due to the characteristics of mechanism the product is equipped with.

When the product is first powered on works properly, the front panel will automatically move into the position (initial setting angle) shown in (Fig. 2).



(Fig. 1)

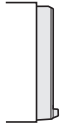

(Fig. 2)

## Cleaning The Unit

If the faceplate of this unit is stained, wipe it with a dry soft cloth such as a silicon cloth. If the faceplate is stained badly, wipe the stain off with a cloth moistened with neutral cleaner, then wipe it again with a clean soft dry cloth.



- Applying spray cleaner directly to the unit may affect its mechanical parts. Wiping the faceplate with a hard cloth or using a volatile liquid such as thinner or alcohol may scratch the surface or erase screened print.

## How To Reset Your Unit

If the unit or the connected unit fails to operate properly, reset the unit.

### 1 Press the <Reset> button.

The unit returns to factory settings.

#### **DNX7**

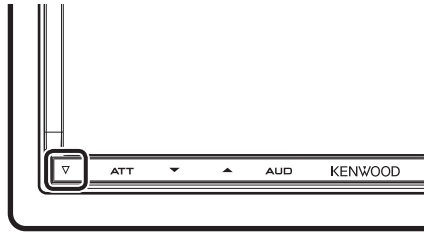

#### **DNX5 DNX4**

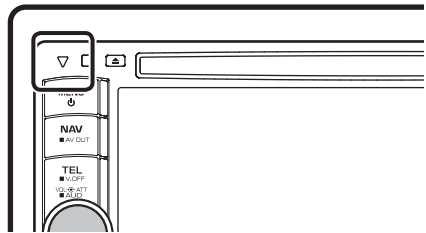

#### NOTE

- Disconnect the USB device before pressing the <Reset> button. Pressing the <Reset> button with the USB device connected can damage the data stored in the USB device. For how to disconnect the USB device, see **How To Play Music (P.17)**.
- When the unit is turned on after resetting, the Initial SETUP screen appears. See **First Step (P.6)**.

## Safety Precautions and Important Information

Read this information carefully before starting to operate the Kenwood Car Navigation System and follow the instructions in this manual. Neither Kenwood nor Garmin shall be liable for problems or accidents resulting from failure to observe the instructions in this manual.

### ⚠️ WARNINGS

#### To prevent injury or fire, take the following precautions:

- To prevent a short circuit, never put or leave any metallic objects (such as coins or metal tools) inside the unit.
- Do not watch or fix your eyes on the unit's display when you are driving for any extended period.
- Mounting and wiring this product requires skills and experience. The mounting and wiring should be done by professionals.

#### Failure to avoid the following potentially hazardous situations could result in an accident or collision resulting in death or serious injury.

When navigating, carefully compare information displayed on the navigation system to all available navigation sources, including information from street signs, visual sightings, and maps. For safety, always resolve any discrepancies or questions before continuing navigation.

Always operate the vehicle in a safe manner.

Do not become distracted by the navigation system while driving, and always be fully aware of all driving conditions. Minimize the amount of time spent viewing the screen of the navigation system while driving, and use voice prompts when possible.

Do not enter destinations, change settings, or access any functions requiring prolonged use of the navigation system controls while driving. Stop your vehicle in a safe and legal manner before attempting such operations.

Keep the system volume at a low enough level to be able to hear outside noises while driving. If you can no longer hear outside noises, you may be unable to react adequately to the traffic situation. This may cause accidents.

The navigation system will not display the correct current position of the vehicle the first time it is used after purchase, or if the vehicle battery is disconnected. GPS satellite signals will soon be received, however, and the correct position will be displayed.

Be careful of the ambient temperature. Using the navigation system at extreme temperatures can lead to malfunction or damage. Also note that the unit can be damaged by strong vibration, by metal objects, or by water getting inside the unit.

### ⚠️ CAUTIONS

#### Failure to avoid the following potentially hazardous situations may result in injury or property damage.

The navigation system is designed to provide you with route suggestions. It does not reflect road closures or road conditions, weather conditions, or other factors that may affect safety or timing while driving.

Use the navigation system only as a navigational aid. Do not attempt to use the navigation system for any purpose requiring precise measurement of direction, distance, location, or topography.

The Global Positioning System (GPS) is operated by the United States government, which is solely responsible for its accuracy and maintenance. The government system is subject to changes that could affect the accuracy and performance of all GPS equipment, including the navigation system. Although the navigation system is a precision navigation device, any navigation device can be misused or misinterpreted and, therefore, become unsafe.

### IMPORTANT INFORMATION

#### Vehicle Battery Preservation

This navigation system can be used when the ignition key is turned to ON or ACC. To preserve the battery, however, it should be used with the engine running whenever possible. Using the navigation system for a long time with the engine switched off can cause the battery to run down.

## Map Data Information

One of the goals of Garmin is to provide customers with the most complete and accurate cartography that is available to us at a reasonable cost. We use a combination of governmental and private data sources, which we identify in product literature and copyright messages displayed to the consumer. Virtually all data sources contain some inaccurate or incomplete data. In some countries, complete and accurate map information is either not available or is prohibitively expensive.

## First Step

Power on the unit and perform some setup steps before using.

### **DNX7**

Press the <NAV>, <MENU>, or <TEL> button.

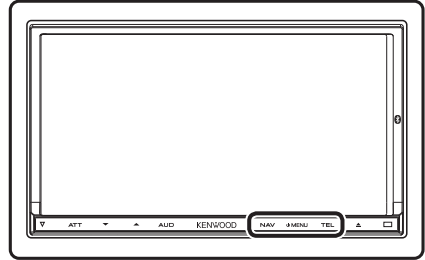

The unit is turned on.

#### ● To turn off the unit:

Press the <MENU> button for 1 second.

### **DNX5 DNX4**

Press the <MENU> button.

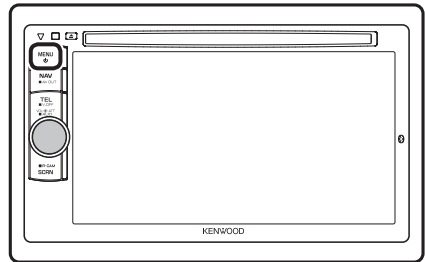

The unit is turned on.

#### ● To turn off the unit:

Press the <MENU> button for 1 second.

The "Initial setup" is only necessary when you use the unit for the first time after purchase, and when you reset the unit.

## 1 Touch the corresponding key and set the value.



### Language

Select the language used for the control screen and setting items. Default is "British English (en)" for DNX7280BT/DNX5280BT/DNX4280BT and "Russian" for DNX5580BT.

After setting, touch [Enter].

### Angle **DNX7**

Adjust the position of the monitor. Default is "0".

After setting, touch [↩].

### iPod AV Interface Use

Set the terminal which your iPod is connected to. Default is "iPod".

### Color

Set the screen and button illumination color. You can select whether to perform color scan and adjust scanning color.

After setting, touch [↩].

### EXT SW **DNX7**

Control the external devices.

After setting, touch [↩].

### Camera

Set the parameters for the camera.

After setting, touch [↩].

## 2 Touch [Finish].

### NOTE

- For details on operations of each setting, refer to the Instruction Manual.
- You can adjust the front panel button (ATT button, etc.) sensitivity of **DNX7**. For details, refer to **Panel Switch Sensitivity (P.68)** in the Instruction Manual.

# Basic Operations

## Functions Of The Buttons On The Front Panel

### DNX7280BT

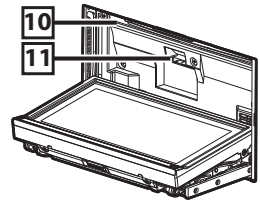
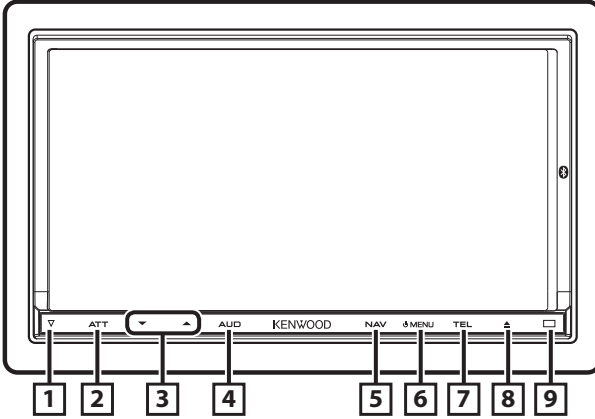



Number	Name	Motion
1	▽ (Reset)	<ul style="list-style-type: none"> <li>If the unit or the connected unit fails to operate properly, the unit returns to factory settings when this button is pressed (<b>Instruction Manual P.92</b>).</li> </ul>
2	ATT	<ul style="list-style-type: none"> <li>Switches attenuation of the volume on/off.</li> <li>Pressing for 1 second turns the screen off.</li> </ul>
3	▼, ▲ (Vol)	<p>Adjusts volume.</p> <p>Holding down a key turns up the volume in series up to 25. For more than 25, pressing the key turns up the volume one by one.</p>
4	AUD	<ul style="list-style-type: none"> <li>Displays Graphic Equalizer screen (<b>Instruction Manual P.82</b>).*</li> <li>Pressing for 1 second switches camera view display on/off.</li> </ul>
5	NAV	<ul style="list-style-type: none"> <li>Displays the navigation screen.</li> <li>Pressing for 1 second switches AV out sources.</li> <li>When the power off, turns the power on.</li> </ul>
6	MENU	<ul style="list-style-type: none"> <li>Displays the Top Menu screen (<b>Instruction Manual P.17</b>).</li> <li>Pressing for 1 second turns the power off.</li> <li>When the power off, turns the power on.</li> </ul>
7	TEL	<ul style="list-style-type: none"> <li>Displays the Hands Free screen (<b>Instruction Manual P.56</b>).</li> <li>Pressing for 1 second displays the Screen Control screen.</li> <li>When the power off, turns the power on.</li> </ul>
8	▲ (Eject)	<ul style="list-style-type: none"> <li>Ejects the disc.</li> <li>Pressing for 1 second opens the panel to the location of the disc slot. When the panel is opened, pressing for 1 second closes the panel and pressing for 3 seconds ejects the disc forcibly.</li> <li>When the panel is closed, pressing for 3 seconds fully opens the panel to the location of the SD card slot.</li> </ul>
9	Remote Sensor	<ul style="list-style-type: none"> <li>Receives the remote control signal. You can enable or disable this feature by Remote Sensor (<b>Instruction Manual P.67</b>).</li> <li>If [Remote Sensor] is set to off, the remote control of TV reception is rejected.</li> </ul>
10	Disc insert slot	A slot to insert a disc media.
11	SD card slot	<p>A slot to insert an SD card. The card is used for upgrading the map. For how to upgrade the map, refer to the instruction manual of the navigation system.</p> <p>Also, you can play audio/visual file in the card.</p>

\*The display may not switch to the Graphic Equalizer screen in some conditions.

**DNX5280BT/DNX4280BT/DNX5580BT**

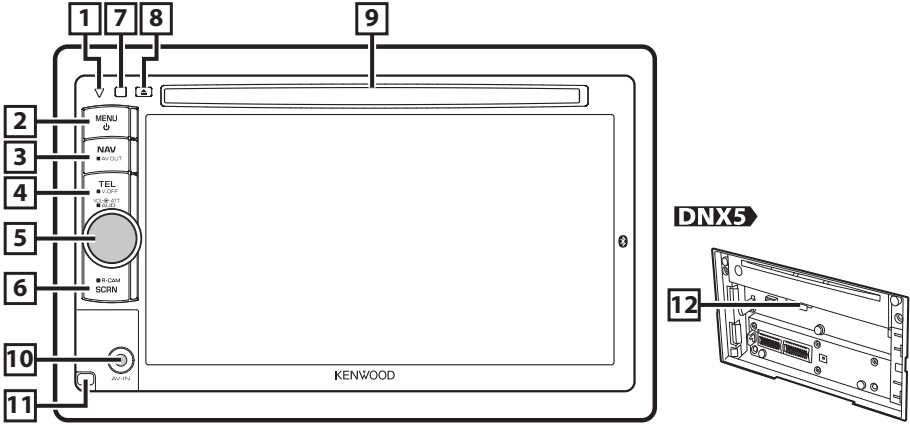

Number	Name	Motion
1	▽ (Reset)	<ul style="list-style-type: none"> <li>If the unit or the connected unit fails to operate properly, the unit returns to factory settings when this button is pressed (<b>Instruction Manual P.92</b>).</li> <li><b>DNX4</b> If the SI function is turned on, this indicator flashes when the vehicle ignition is off (<b>Instruction Manual P.69</b>).</li> </ul>
2	MENU	<ul style="list-style-type: none"> <li>Displays the Top Menu screen (<b>Instruction Manual P.17</b>).</li> <li>Pressing for 1 second turns the power off.</li> <li>When the power off, turns the power on.</li> </ul>
3	NAV	<ul style="list-style-type: none"> <li>Displays the navigation screen.</li> <li>Pressing for 1 second switches AV out sources.</li> </ul>
4	TEL	<ul style="list-style-type: none"> <li>Displays the Hands Free screen (<b>Instruction Manual P.56</b>).</li> <li>Pressing for 1 second turns the screen off.</li> </ul>
5	Volume Knob	<ul style="list-style-type: none"> <li>Pressing switches attenuation of the volume on/off.</li> <li>Turning adjusts volume up or down.</li> <li>Pressing for 1 second displays Tone Control screen (<b>Instruction Manual P.83</b>).*</li> </ul>
6	SCRN	<ul style="list-style-type: none"> <li>Displays the Screen Control screen.</li> <li>Pressing for 1 second displays rear view camera display.</li> </ul>
7	Remote Sensor	<ul style="list-style-type: none"> <li>Receives the remote control signal. You can enable or disable this feature by Remote Sensor (<b>Instruction Manual P.67</b>).</li> <li>If [Remote Sensor] is set to off, the remote control of TV reception is rejected.</li> </ul>
8	▲ (Eject)	<ul style="list-style-type: none"> <li>Ejects the disc.</li> <li>Pressing for 1 second ejects the disc forcibly.</li> </ul>
9	Disc insert slot	A slot to insert a disc media.
10	<b>DNX5</b> Input jack	An input jack for external device.
11	<b>DNX5</b> Release key	Detaches the front panel.
12	SD card slot	A slot to insert an SD card. The card is used for upgrading the map. For how to upgrade the map, refer to the instruction manual of the navigation system. For DNX5280BT, you can play audio/visual file in the card.

\*The display may not switch to the Tone Control screen in some conditions.

## Common Operations

### General

There are some functions which can be operated from most screens.



#### [Menu]

Returns to the Top Menu screen.

#### ↩ (RETURN)

Returns to previous screen.

#### ← (common menu key)

Touch to display the common menu. The contents of the menu are as follows.

⏏ : **DNX7** Displays the EXT SW Control screen.

⏏ : Displays the SETUP Menu screen.

⏏ : Displays the Audio Control Menu screen.

⏏ : Displays the control screen of current source. Icon feature differs depending on the source.

⏏ : Closes the menu.

### List screen

There are some common function keys in the list screens of most sources.



#### ⏏ (Scroll)

Scrolls the displayed text.

#### All > etc.

Touch keys with various functions are displayed here.

Displayed keys differ depending on the current audio source, status, etc.

For examples, see **List screen (P.19)** in the Instruction Manual.

### Flick scrolling

You can scroll the list screen by flicking the screen up/down or right/left.

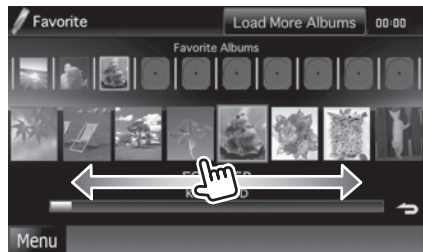
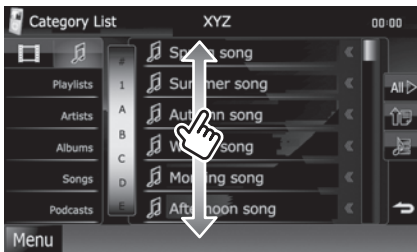

## Detaching The Front Panel **DNX7** **DNX5**

You can detach the front panel to prevent theft.

### **DNX7**

Press the <▲> button for 3 seconds to open the front panel.

Then, detach the panel as the diagrams below.

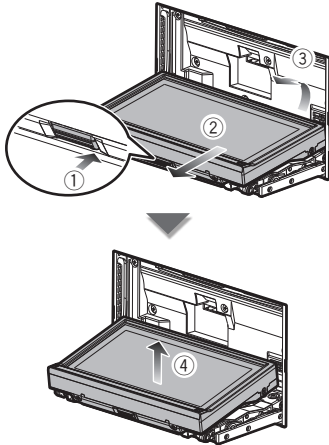

#### **NOTE**

- The attaching plate closes automatically in about 10 seconds after the front panel is released. Remove the panel before this happens.
- It closes automatically when no operation is done for about a minute.

### **DNX5**

Detach the panel as the diagram below.

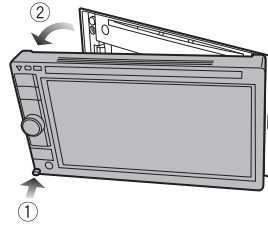

#### ● **After detaching:**

Put the panel in the protective bag supplied with the unit.

#### **NOTE**

- To prevent deterioration, do not touch the terminals of the unit and faceplate with your fingers.
- If the terminals on the unit or faceplate get dirty, wipe them with a clean soft dry cloth.
- For attaching the panel, see **Attaching the front panel (P.25)**.

# How To Use The Navigation System

**1 Press the <NAV> button to display the navigation screen.**

**2 Operate the desired function from the Main Menu screen.**



1	GPS satellite strength.
2	Finds a destination.
3	Views the map.
4	Adjusts the settings.
5	Uses the tools such as ecoRoute and Help.

**NOTE**

• You can get additional information about using the navigation system from Help. To display Help, touch [Tools] and then touch [Help].



• For more information about your navigation system, download the latest version of the Owner's Manual from [manual.kenwood.com/edition/im324](http://manual.kenwood.com/edition/im324).

**3 Enter your destination and start the guidance.**

**● Finding points of interest**

- 1) Touch [Where To?].
- 2) Touch [Points of Interest].
- 3) Select a category and a subcategory.
- 4) Select a destination.
- 5) Touch [Go!].

**NOTE**

- To enter letters contained in the name, touch [Where To?] - [Points of Interest] - [Spell Name].
- To search for a location in a different area, touch [Where To?] and then touch [Near].

## 4 Follow your route to the destination.

### NOTICE

- The speed limit icon feature is for information only and does not replace the driver's responsibility to abide by all posted speed limit signs and to use safe driving judgment at all times. Garmin and Kenwood will not be responsible for any traffic fines or citations that you may receive for failing to follow all applicable traffic laws and signs.

Your route is marked with a magenta line. As you travel, your navigation system guides you to your destination with voice prompts, arrows on the map, and directions at the top of the map. If you depart from the original route, your navigation system recalculates the route.

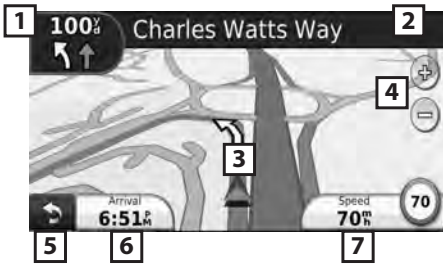

1	Views the Next Turn page or the junction view page, when available.
2	Views the Turn List page.
3	Views the Where Am I? page.
4	Zooms in and out.
5	Returns to the Main Menu.
6	Displays a different data field.
7	Views the Trip Computer.



### NOTE

- Touch and drag the map to view a different area of the map.
- A speed limit icon could appear as you travel on major roadways.

### ● Adding a stop

- 1) While navigating a route, touch [  ] and then touch [Where To?].
- 2) Search for the extra stop.
- 3) Touch [Go!].
- 4) Touch [Add as Via Point] to add this stop before your final destination.

### ● Taking a detour

- 1) While navigating a route, touch [  ].
- 2) Touch [  ].

## Other Features

### ● Manually avoiding traffic on your route

- 1) From the map, touch the traffic icon.
- 2) Touch [Traffic On Route].
- 3) If necessary, touch the arrows to view other traffic delays on your route.
- 4) Touch [Avoid].

### ● Viewing the traffic map

The traffic map shows color-coded traffic flow and delays on nearby.

### ● About traffic

#### NOTICE

- Garmin and Kenwood are not responsible for the accuracy or timeliness of the traffic information.  
With an FM traffic receiver, the navigation system can receive and use traffic information. When a traffic message is received, you can see the event on the map and change your route to avoid the incident. The FM TMC subscription activates automatically after your navigation system acquires satellite signals while receiving traffic signals from the service provider. Go to [www.garmin.com/fmtraffic](http://www.garmin.com/fmtraffic) for more information.

### ● Updating the software

To update the navigation system software, you must have a memory card, a memory card reader, and an internet connection.

#### NOTE

- The unit may restart when you insert a memory card.

- 1) Go to [www.garmin.com/Kenwood](http://www.garmin.com/Kenwood).
- 2) Find your model and select [Software Updates] > [Download].
- 3) Read and accept the terms of the Software License Agreement.
- 4) Follow the instructions on the Web site to complete the installation of the software update.

### ● Updating maps

You can purchase updated map data from Garmin or ask your Kenwood dealer or Kenwood service center for details.

- 1) Go to [www.garmin.com/Kenwood](http://www.garmin.com/Kenwood).
- 2) Select [Order Map Updates] for your Kenwood unit.
- 3) Follow the Web site instructions to update your map.



# How To Play Music

You can play audio files from music CD, disc media, USB storage device, SD card and iPod.

## NOTE

• For details on playable file format, media format, iPod model, etc., refer to the Instruction Manual.

## 1 Connect the media you want to play as show below.

### Disc

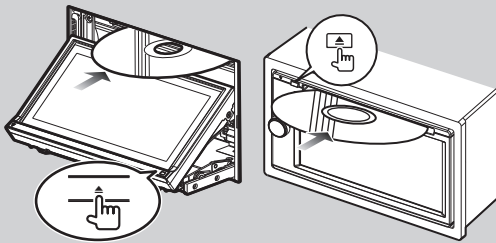

#### **DNX7**

- 1) Press the <▲> button for 1 second to open the front panel.
- 2) Insert the disc into the slot.

#### **DNX5** **DNX4**

- 1) Insert the disc into the slot.  
→ *Playback starts.*

#### ● **To eject the disc:**

Press the <▲> button. For **DNX7**, the panel should be closed.

### iPod, USB device

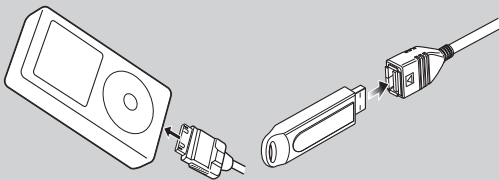

- 1) Connect the device with each cable.  
→ *Playback starts.*

#### ● **To disconnect the device:**

Touch [◀] on the screen and then touch [▲] for 1 second.  
Disconnect the device from the cable.

### SD card

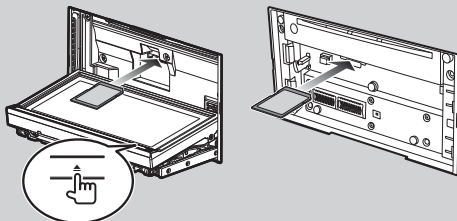

Notched section

Labeled side

#### **DNX7280BT**

- 1) Press [▲] for longer than 1 second to open the front panel and insert the card.

#### **DNX5280BT**

- 1) Detach the front panel and insert the card.  
→ *Playback starts.*

#### ● **To eject the card:**

Push the card until it clicks and then remove your finger from the card. The card pops up so that you can pull it out.

*Continued*

## 2 Control the music you are listening to on the source control screen.

The following symbols indicate the keys on the screen.

The functions of the keys are the same despite the difference of the source you are listening to.

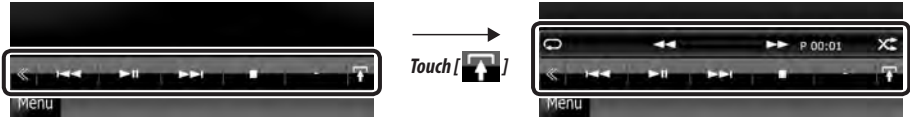

Basic operations from this screen

Plays or pauses:	▶
Stops playing:	■
Disconnects the device:	▲
Searches the previous/next content:	◀▶▶▶
Fast forwards or Fast backwards:	◀◀▶▶ or move the cursor in the center bar
Repeats current content:	◁
Plays all contents in random order:	✕

### NOTE

- For other operations, refer to the Instruction Manual.
- If desired key is not displayed in the multi-function bar, touch the [◀] to switch the menu.

## 3 Search the track/file you want to listen to.

### ● List search

- 1) Touch center of the screen.

The content list of the media being played is displayed.

If the information of the current track only is displayed, touch [Up Arrow] to switch the list display.



### ● Refined search

- 1) Touch [Q].
- 2) Touch the desired refinement method.  
The list is refined by the item you selected.
- 3) Touch the desired item.



### NOTE

- For details on searching operations, refer to **Search Operation (P.36)** in the Instruction Manual.

# How To Play Movie/Picture

You can play DVD video, Video CD (VCD), movie files from disc media, iPod, and picture files from USB storage device and SD card.

## NOTE

- For details on playable file format, device format, etc., refer to the Instruction Manual.

## 1 Connect the media you want to play.

For the method of connecting, see **How To Play Music (P.17)**.

## 2 Control the movie/picture by touching the screen.

Each area on the screen has a separate function.



1	2	3
DVD: Displays the DVD menu.* <sup>1</sup> VCD: Displays the Zoom Control screen.* <sup>2</sup> Disc media: Displays the disc menu.* <sup>3</sup>	Displays the Source Control screen.	<ul style="list-style-type: none"> <li>• Searches the next/previous content or file.</li> <li>• Scrolling from center of display to left or right performs fast backward or fast forward.</li> <li>To stop fast backward/forward, touch center of the display.*<sup>4</sup></li> </ul>



\*<sup>1</sup> See **DVD Disc Menu Operation (P.25)** in the Instruction Manual.

\*<sup>2</sup> See **Zoom Control For DVD And VCD (P.26)** in the Instruction Manual.

\*<sup>3</sup> See **Movie Control (P.41)** in the Instruction Manual.

\*<sup>4</sup> For iPod/USB/SD card, this function may be unavailable depending on the playing file format.

## NOTE

- For operations on the source control screen, see **How To Play Music (P.17)**. However, searching by category/link/album artwork is not available.
- Touching [  ] (displayed by touching [  ] in the source control screen) hides all keys.

# How To Listen To The Radio

## 1 Touch [Menu] on any screen.

Top Menu screen appears.

## 2 Touch [TUNER].

The unit switches to the radio source.



## 3 Operate on the source control screen.

### ● Station search

- 1) Touch [  ].  
Sub function menu appears.
- 2) Touch [AM] or [FM] to select the band.
- 3) Touch [◀◀] or [▶▶] to tune in the desired station.



### ● Auto memory

- 1) Touch [  ].  
Sub function menu appears.
- 2) Touch [AM] or [FM] to select the band.
- 3) Touch [  ].
- 4) Touch [AME].
- 5) Touch [◀◀] or [▶▶] in the sub function menu.  
Auto memory starts.

### ● Recalling the preset station

- 1) Touch [P#].  
You can also display the preset list by touching the frequency display in the center.

#### NOTE

• For other operations, see **Radio Basic Operation (P.44)** in the Instruction Manual.

# How To Make A Phone Call

You can use your Bluetooth cell-phone when paired to this unit.

## 1 Register your cell-phone to the unit.

Follow the procedures shown below. For detailed operation, see **Registering the Bluetooth Unit (P.53)** in the Instruction Manual.

- 1) Press the <TEL> button and touch [BT SETUP].
- 2) Touch [SET] of [Regist New Device] in the Bluetooth SETUP screen.



- 3) Touch [PIN Code Set] in the Searched Device List screen.
- 4) Enter PIN code and touch [Enter].
- 5) Select your cell-phone from the displayed list in the Searched Device List screen.  
Registering is completed.



## 2 Connect your cell-phone to the unit.

- 1) Touch [SET] of [Paired Device List] in the Bluetooth SETUP screen.
- 2) Touch the desired device from the list and touch [TEL(HFP)].  
The selected device is connected to the unit.



### NOTE

- Touch [Audio(A2DP)] if you want to connect the device as an audio player. This key appears only for **DNX7**.

## 3 Download your phonebook.

- 1) Operate the cell-phone to send the phonebook data to this unit.
- 2) Operate the cell-phone to start the hands-free connection.

### NOTE

- See the instruction manual of your cell-phone for the operation.

## 4 Make or receive a phone call.

See the table below for each operation method.

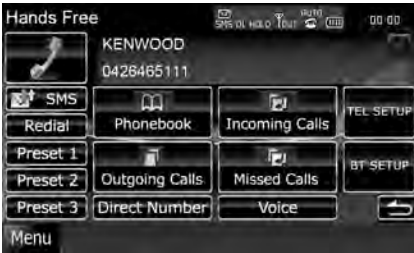

### Call by entering a phone number

- ① Touch [Direct Number].
- ② Enter a phone number with number keys.
- ③ Touch [  ].

### Call using call records

- ① Touch [Incoming Calls], [Outgoing Calls], or [Missed Calls].
- ② Select the phone number from the list.
- ③ Touch [  ].

### Redial

- ① Touch [Redial] to display the previously called number.
- ② Touch [  ].

### Call using the phonebook

- ① Touch [Phonebook].
- ② Select the name from the list.
- ③ Select the number from the list.
- ④ Touch [  ].

### Call using the preset number

- ① Touch [Preset #] to start calling the corresponding phone number.

### Call using voice recognition

It is necessary to register your voice in the phonebook data. For details, see **Voice registration (P.64)** and **Key word voice registration (P.65)**.

- ① Touch [Voice].
- ② Say the name registered in the phonebook within 2 seconds after a beep.
- ③ Touch [  ].

#### NOTE

- For detailed operation, see **Using Hands-Free Unit (P.56)** in the Instruction Manual.

# Installation Procedure

## Before Installation

Before installation of this unit, please note the following precautions.

### ⚠️ WARNINGS

- If you connect the ignition wire (red) and the battery wire (yellow) to the car chassis (ground), you may cause a short circuit, that in turn may start a fire. Always connect those wires to the power source running through the fuse box.
- Do not cut out the fuse from the ignition wire (red) and the battery wire (yellow). The power supply must be connected to the wires via the fuse.

### ⚠️ CAUTION

- Install this unit in the console of your vehicle.  
Do not touch the metal part of this unit during and shortly after the use of the unit. Metal part such as the heat sink and enclosure become hot.

### NOTES

- Mounting and wiring this product requires skills and experience. For best safety, leave the mounting and wiring work to professionals.
- Make sure to ground the unit to a negative 12V DC power supply.
- Do not install the unit in a spot exposed to direct sunlight or excessive heat or humidity. Also avoid places with too much dust or the possibility of water splashing.
- Do not use your own screws. Use only the screws provided. If you use the wrong screws, you could damage the unit.
- If the power is not turned ON ("PROTECT" is displayed), the speaker wire may have a short-circuit or touched the chassis of the vehicle and the protection function may have been activated. Therefore, the speaker wire should be checked.
- If your car's ignition does not have an ACC position, connect the ignition wires to a power source that can be turned on and off with the ignition key. If you connect the ignition wire to a power source with a constant voltage supply, such as with battery wires, the battery may be drained.



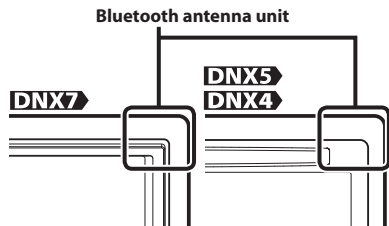

- If the console has a lid, make sure to install the unit so that the faceplate will not hit the lid when closing and opening.
- If the fuse blows, first make sure the wires aren't touching to cause a short circuit, then replace the old fuse with one with the same rating.
- Insulate unconnected wires with vinyl tape or other similar material. To prevent a short circuit, do not remove the caps on the ends of the unconnected wires or the terminals.
- Connect the speaker wires correctly to the terminals to which they correspond. The unit may be damaged or fail to work if you share the ⊖ wires or ground them to any metal part in the car.
- When only two speakers are being connected to the system, connect the connectors either to both the front output terminals or to both the rear output terminals (do not mix front and rear). For example, if you connect the ⊕ connector of the left speaker to a front output terminal, do not connect the ⊖ connector to a rear output terminal.
- After the unit is installed, check whether the brake lamps, blinkers, wipers, etc. on the car are working properly.
- Mount the unit so that the mounting angle is 30° or less.
- This unit has the cooling fan (**P.28**) to decrease the internal temperature. Do not mount the unit in a place where the cooling fan of the unit are blocked. Blocking these openings will inhibit the cooling of the internal temperature and result in malfunction.
- Do not press hard on the panel surface when installing the unit to the vehicle. Otherwise scars, damage, or failure may result.
- Make sure that all wire connections are securely made by inserting jacks until they lock completely.
- Use a commercially available conversion connector if the connector does not fit in the vehicle connector.
- Reception may drop if there are metal objects near the Bluetooth antenna.

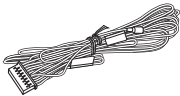
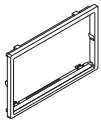

## Installation Procedure

### Supplied accessories

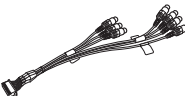
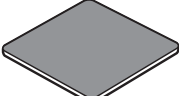
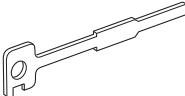
First of all, make sure that all accessories are supplied with the unit.

① ...1 	⑥ ...1 
② ...1 <b>DNX7</b> 	⑦ ...1 
③ ...1 <b>DNX7</b> 	⑧ ...1 
④ ...2 	⑨ ...1 
⑤ ...1 <b>DNX7</b> <b>DNX5</b> 	

### Unit

- 1 To prevent a short circuit, remove the key from the ignition and disconnect the  $\ominus$  terminal of the battery.

- 2 Make the proper input and output wire connections for each unit.
- 3 Connect the wire on the wiring harness.
- 4 Take Connector B on the wiring harness and connect it to the speaker connector in your vehicle.
- 5 Take Connector A on the wiring harness and connect it to the external power connector on your vehicle.
- 6 Connect the wiring harness connector to the unit.
- 7 Install the unit in your car.
- 8 Reconnect the  $\ominus$  battery.
- 9 Press the <Reset> button.
- 10 Perform the Initial Setup. See **First Step (P.6)**.

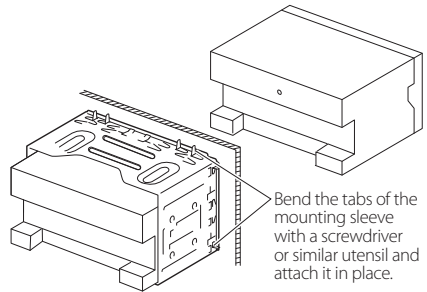

#### NOTE

- Make sure that the unit is installed securely in place. If the unit is unstable, it may malfunction (eg, the sound may skip).

### Escutcheon

Attach accessory ⑥ to the unit.

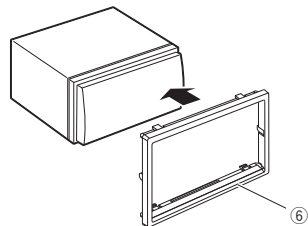



## Attaching the front panel

Hold the front panel securely so as not to drop it accidentally. Fit the panel onto the attaching plate until it is firmly locked.

### DNX7

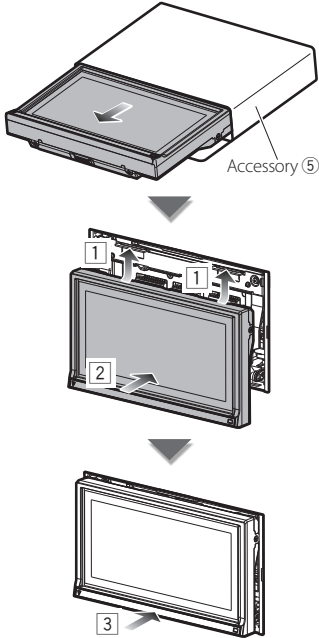

### DNX5

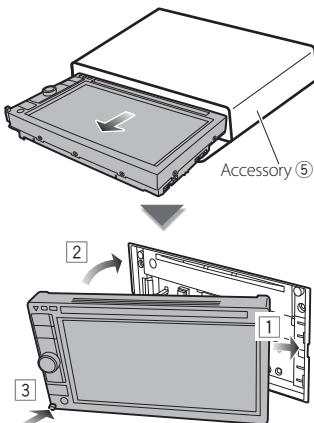

## GPS antenna

GPS antenna is installed inside of the car. It should be installed as horizontally as possible to allow easy reception of the GPS satellite signals.

To mount the GPS antenna inside your vehicle:

- 1) Clean your dashboard or other surface.
- 2) Peel the backing off of the adhesive on the bottom of the metal plate (accessory ⑧).
- 3) Press the metal plate (accessory ⑧) down firmly on your dashboard or other mounting surface. You can bend the metal plate (accessory ⑧) to conform to a curved surface, if necessary.
- 4) Place the GPS antenna (accessory ⑦) on top of the metal plate (accessory ⑧).

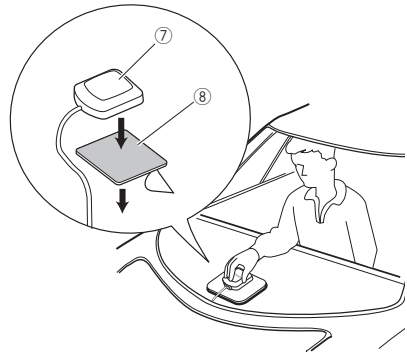

- Depending on the type of car, reception of the GPS satellite signals might not be possible with an inside installation.
- The GPS antenna should be installed at a position that is spaced at least 12 inch (30 cm) from cellular phone or other transmitting antennas. Signals from the GPS satellite may be interfered with by these types of communication.
- Painting the GPS antenna with (metallic) paint may cause a drop in performance.

## Microphone unit

- 1) Check the installation position of the microphone (accessory ⑨).
- 2) Remove oil and other dirt from the installation surface.
- 3) Install the microphone.
- 4) Wire the microphone cable up to the unit with it secured at several positions using tape or other desired method.

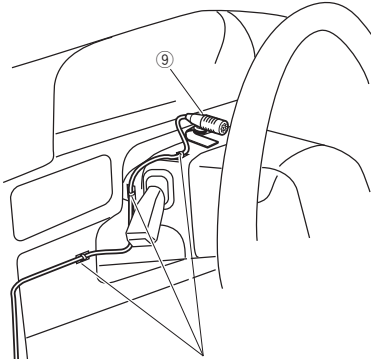

Fix a cable with a commercial item of tape.

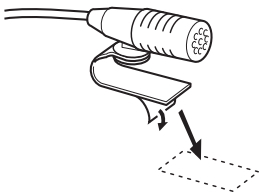

Peel the release coated paper of double-face adhesive tape to fix on the place shown above.



Adjust the direction of the microphone to the driver.

### NOTE

- Install the microphone as far as possible from the cell-phone.

## Removing Procedure

### Removing the hard rubber frame (escutcheon)

- 1) Engage the catch pins on the removal tool (accessory ④) and remove the two locks on the lower level.  
Lower the frame and pull it forward as shown in the figure.

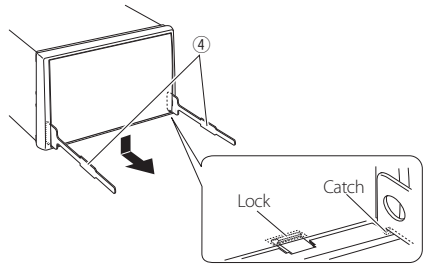

### NOTE

- The frame can be removed from the top side in the same manner.

- 2) When the lower level is removed, remove the upper two locations.

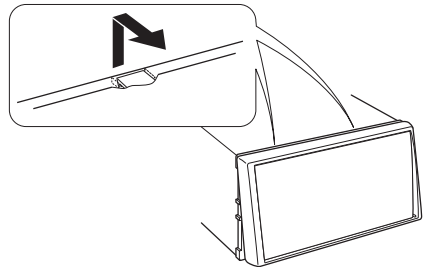

## Removing the unit

- 1) Remove the hard rubber frame by referring to **step 1 in "Removing the hard rubber frame" (P.26)**.
- 2) Insert the two removal tools (accessory ④) deeply into the slots on each side, as shown.

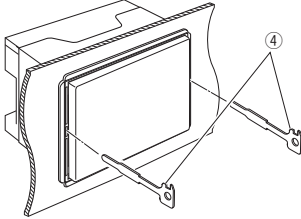

- 3) Lower the removal tool toward the bottom, and pull out the unit halfway while pressing towards the inside.

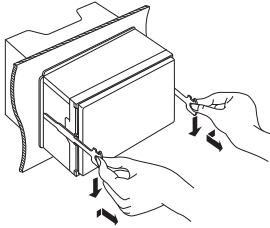

### NOTE

- Be careful to avoid injury from the catch pins on the removal tool.

- 4) Pull the unit all the way out with your hands, being careful not to drop it.

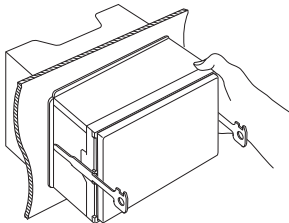

## Connector Function Guide

Pin Numbers for ISO Connectors	Cable Color	Functions
External Power Connector		
A-4	Yellow	Battery
A-5	Blue/White	Power Control
A-6	Orange/White	Dimmer
A-7	Red	Ignition (ACC)
A-8	Black	Earth (Ground) Connection
Speaker Connector		
B-1	Purple	Rear Right (+)
B-2	Purple/Black	Rear Right (-)
B-3	Gray	Front Right (+)
B-4	Gray/Black	Front Right (-)
B-5	White	Front Left (+)
B-6	White/Black	Front Left (-)
B-7	Green	Rear Left (+)
B-8	Green/Black	Rear Left (-)

\*Speaker Impedance: 4-8 Ω

## Connection

### Connecting wires to terminals (1)

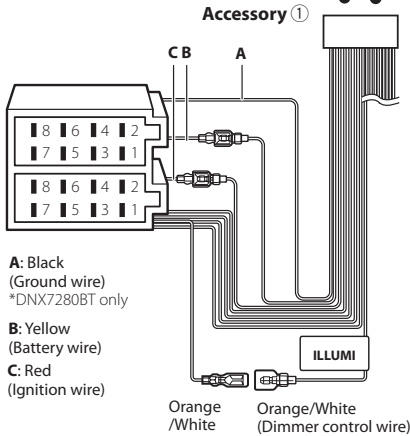
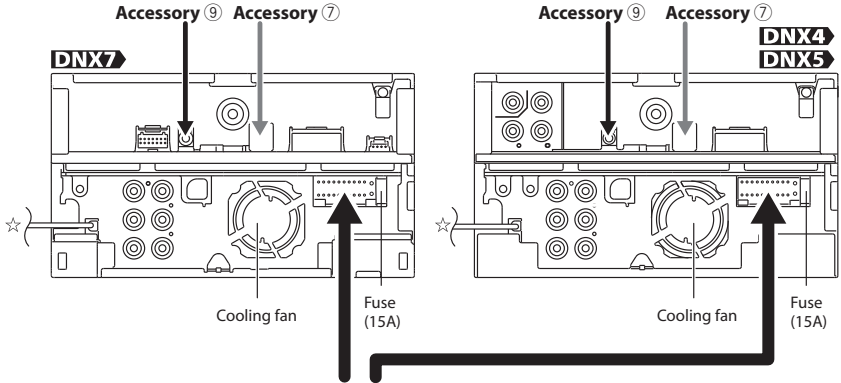

#### ▲ WARNING for Connecting the ISO Connector

The pin arrangement for the ISO connectors depends on the type of vehicle you drive. Make sure to make the proper connections to prevent damage to the unit. The default connection for the wiring harness is described in (1) below. If the ISO connector pins are set as described in (2), make the connection as illustrated. Please be sure to reconnect the cable as shown (2) below to install this unit to the **Volkswagen** vehicles etc.

#### (1): Default setting

The red (A-7 pin) of the vehicle's ISO connector is linked with the ignition, and the yellow (A-4 pin) is connected to the constant power supply.

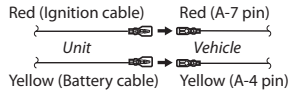

#### (2)

The red (A-7 pin) of the vehicle's ISO connector is connected to the constant power supply, and the yellow (A-4 pin) is linked to the ignition.

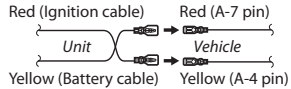

#### ☆ FM/AM antenna input



#### Accessory ⑨: Bluetooth Microphone

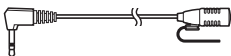

#### Accessory ⑦: GPS Antenna

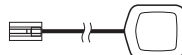

## Connecting wires to terminals (2)

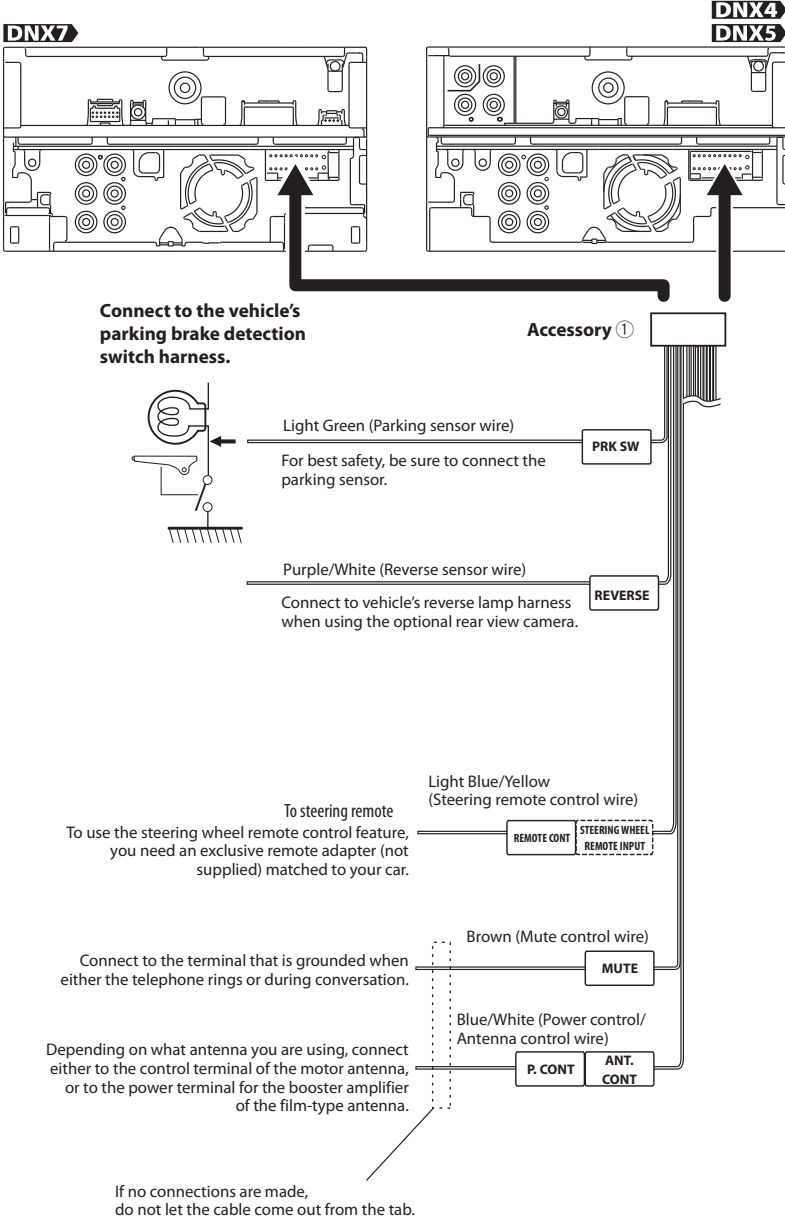

## System connection

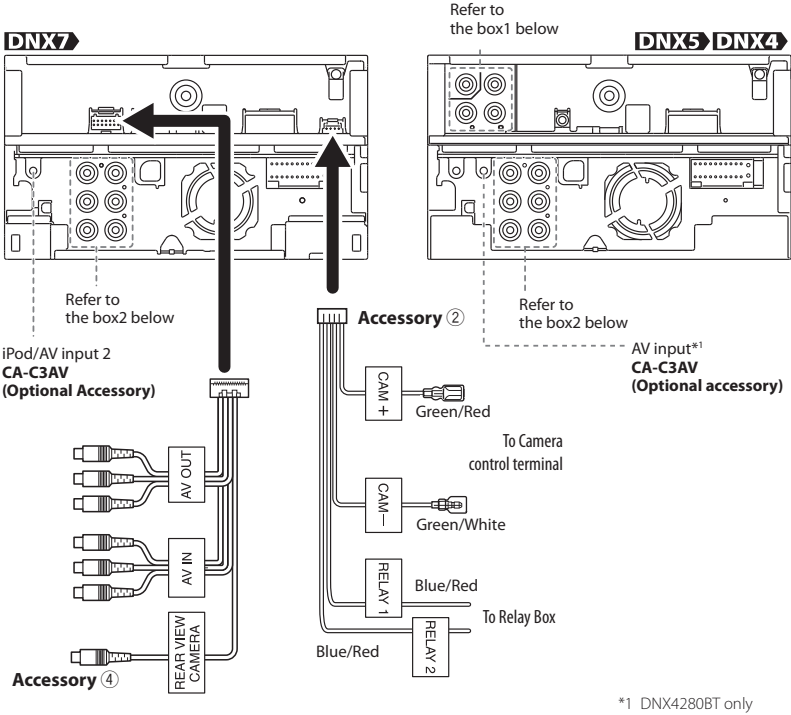

1

### Rear View Camera Input

- Yellow (Visual Input)

### Audio/Visual Output

- Yellow (Visual Output)
- White (Audio Left Output)
- Red (Audio Right Output)

2

### Rear Preout

- Red (Audio Right Output)
- White (Audio Left Output)

### Front Preout

- Red (Audio Right Output)
- White (Audio Left Output)

### Subwoofer Preout

- Red (Audio Right Output)
- White (Audio Left Output)

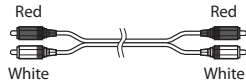

Use an RCA cable as shown in above diagram.

### NOTE

- Front and subwoofer preout are unavailable for DNX4280BT.

## Optional accessory connection

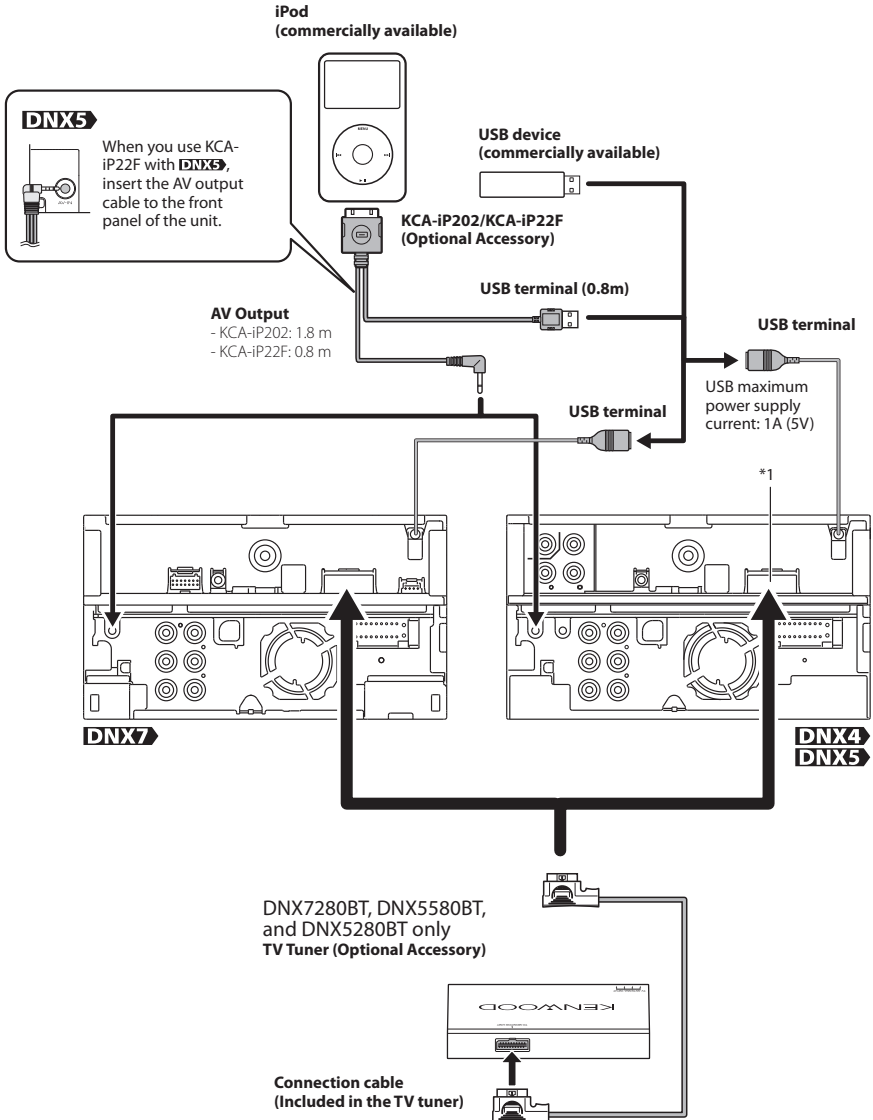

\*1 DNX5580BT and DNX5280BT only

## About This Unit

### ■ Copyrights

- The Bluetooth word mark and logos are owned by the Bluetooth SIG, Inc. and any use of such marks by Kenwood Corporation is under license. Other trademarks and trade names are those of their respective owners.
- The "AAC" logo is a trademark of Dolby Laboratories.
- "Made for iPod" and "Made for iPhone" mean that an electronic accessory has been designed to connect specifically to iPod or iPhone, respectively, and has been certified by the developer to meet Apple performance standards. Apple is not responsible for the operation of this device or its compliance with safety and regulatory standards. Please note that the use of this accessory with iPod, iPhone, or iPad may affect wireless performance.  
iPhone, iPod, iPod classic, iPod nano, and iPod touch are trademarks of Apple Inc., registered in the U.S. and other countries.
-  is a trademark of DVD Format/Logo Licensing Corporation registered in the U.S., Japan and other countries.
- This item incorporates copy protection technology that is protected by U.S. patents and other intellectual property rights of Rovi Corporation. Reverse engineering and disassembly are prohibited.
- Manufactured under license from Dolby Laboratories. Dolby and the double-D symbol are trademarks of Dolby Laboratories.
- Manufactured under license under U.S. Patent #'s: 5,451,942; 5,956,674; 5,974,380; 5,978,762; 6,487,535 & other U.S. and worldwide patents issued & pending. DTS and the Symbol are registered trademarks & DTS 2.0 Channel and the DTS logos are trademarks of DTS, Inc. Product includes software. © DTS, Inc. All Rights Reserved.
- Font for this product is designed by Ricoh.

### ■ ABOUT DIVX VIDEO:

DivX® is a digital video format created by DivX, Inc. This is an official DivX Certified® device that plays DivX video. Visit [divx.com](http://divx.com) for more information and software tools to convert your files into DivX video.

### ■ ABOUT DIVX VIDEO-ON-DEMAND:

This DivX Certified® device must be registered in order to play purchased DivX Video-on-Demand (VOD) movies. To obtain your registration code, locate the DivX VOD section in your device setup menu. Go to [vod.divx.com](http://vod.divx.com) for more information on how to complete your registration.

- SDHC logo is trademark.
- DivX®, DivX Certified® and associated logos are trademarks of DivX, Inc. and are used under license.

### ■ The marking of products using lasers

**CLASS 1  
LASER PRODUCT**

The label is attached to the chassis/case and says that the component uses laser beams that have been classified as Class 1. It means that the unit is utilizing laser beams that are of a weaker class. There is no danger of hazardous radiation outside the unit.

### ■ Information on Disposal of Old Electrical and Electronic Equipment and Batteries (applicable for EU countries that have adopted separate waste collection systems)

Products and batteries with the symbol (crossed-out wheeled bin) cannot be disposed as household waste. Old electrical and electronic equipment and batteries should be recycled at a facility capable of handling these items and their waste byproducts.

Contact your local authority for details in locating a recycle facility nearest to you.

Proper recycling and waste disposal will help conserve resources whilst preventing detrimental effects on our health and the environment.

Notice: The sign "Pb" below the symbol for batteries indicates that this battery contains lead.



This Product is not installed by the manufacturer of a vehicle on the production line, nor by the professional importer of a vehicle into an EU Member State.





## Declaration of Conformity with regard to the EMC Directive 2004/108/EC

## Declaration of Conformity with regard to the R&TTE Directive 1999/5/EC

### Manufacturer:

Kenwood Corporation  
2967-3 Ishikawa-machi, Hachioji-shi, Tokyo, 192-8525 Japan

### EU Representative's:

Kenwood Electronics Europe BV  
Amsterdamseweg 37, 1422 AC UITHOORN, The Netherlands

### English

Hereby, Kenwood declares that this unit DNX7280BT, DNX5580BT, DNX5280BT, DNX4280BT is in compliance with the essential requirements and other relevant provisions of Directive 1999/5/EC.

### Français

Par la présente Kenwood déclare que l'appareil DNX7280BT, DNX5580BT, DNX5280BT, DNX4280BT est conforme aux exigences essentielles et aux autres dispositions pertinentes de la directive 1999/5/CE.

Par la présente, Kenwood déclare que ce DNX7280BT, DNX5580BT, DNX5280BT, DNX4280BT est conforme aux exigences essentielles et aux autres dispositions de la directive 1999/5/CE qui lui sont applicables.

### Deutsch

Hiermit erklärt Kenwood, dass sich dieser DNX7280BT, DNX5580BT, DNX5280BT, DNX4280BT in Übereinstimmung mit den grundlegenden Anforderungen und den anderen relevanten Vorschriften der Richtlinie 1999/5/EG befindet. (BMW)

Hiermit erklärt Kenwood die Übereinstimmung des Gerätes DNX7280BT, DNX5580BT, DNX5280BT, DNX4280BT mit den grundlegenden Anforderungen und den anderen relevanten Festlegungen der Richtlinie 1999/5/EG. (Wien)

### Nederlands

Hierbij verklaart Kenwood dat het toestel DNX7280BT, DNX5580BT, DNX5280BT, DNX4280BT in overeenstemming is met de essentiële eisen en de andere relevante bepalingen van richtlijn 1999/5/EG. Bij deze verklaart Kenwood dat deze DNX7280BT, DNX5580BT, DNX5280BT, DNX4280BT voldoet aan de essentiële eisen en aan de overige relevante bepalingen van Richtlijn 1999/5/EC.

### Italiano

Con la presente Kenwood dichiara che questo DNX7280BT, DNX5580BT, DNX5280BT, DNX4280BT è conforme ai requisiti essenziali ed alle altre disposizioni pertinenti stabilite dalla direttiva 1999/5/CE.

### Español

Por medio de la presente Kenwood declara que el DNX7280BT, DNX5580BT, DNX5280BT, DNX4280BT cumple con los requisitos esenciales y cualesquiera otras disposiciones aplicables o exigibles de la Directiva 1999/5/CE.

### Português

Kenwood declara que este DNX7280BT, DNX5580BT, DNX5280BT, DNX4280BT está conforme com os requisitos essenciais e outras disposições da Directiva 1999/5/CE.

### Polska

Kenwood niniejszym oświadcza, że DNX7280BT, DNX5580BT, DNX5280BT, DNX4280BT spełnia zasadnicze wymogi oraz inne istotne postanowienia dyrektywy 1999/5/EC.

### Český

Kenwood tímto prohlašuje, že DNX7280BT, DNX5580BT, DNX5280BT, DNX4280BT je ve shodě se základními požadavky a s dalšími příslušnými ustanoveními Nařízení vlády č. 426/2000 Sb.

### Magyar

Alulírott, Kenwood, kijelenti, hogy a jelen DNX7280BT, DNX5580BT, DNX5280BT, DNX4280BT megfelel az 1999/5/EC irányelvben meghatározott alapvető követelményeknek és egyéb vonatkozó előírásoknak.

### Svenska

Härmed intygar Kenwood att denna DNX7280BT, DNX5580BT, DNX5280BT, DNX4280BT står i överensstämmelse med de väsentliga egenskapskrav och övriga relevanta bestämmelser som framgår av direktiv 1999/5/EG.

### Suomi

Kenwood vakuuttaa täten että DNX7280BT, DNX5580BT, DNX5280BT, DNX4280BT tyyppinen laite on direktiivin 1999/5/EY oleellisten vaatimusten ja sitä koskevien direktiivin muiden ehtojen mukainen.

### Slovensko

S tem Kenwood izjavlja, da je ta DNX7280BT, DNX5580BT, DNX5280BT, DNX4280BT v skladu z osnovnimi zahtevami in ostalimi ustreznimi predpisi Direktive 1999/5/EC.

### Slovensky

Spoločnosť Kenwood týmto vyhlasuje, že DNX7280BT, DNX5580BT, DNX5280BT, DNX4280BT spĺňa základné požiadavky a ďalšie príslušné ustanovenia Direktivy 1999/5/EC.

### Dansk

Undertegnede Kenwood erklærer herved, at følgende udstyr DNX7280BT, DNX5580BT, DNX5280BT, DNX4280BT overholder de væsentlige krav og øvrige relevante krav i direktiv 1999/5/EF.

### Ελληνικά

ΜΕ ΤΗΝ ΠΑΡΟΥΣΑ Kenwood ΔΗΛΩΝΕΙ ΟΤΙ DNX7280BT, DNX5580BT, DNX5280BT, DNX4280BT ΣΥΜΜΟΡΦΩΝΕΤΑΙ ΠΡΟΣ ΤΙΣ ΟΥΣΙΩΔΕΙΣ ΑΠΑΙΤΗΣΕΙΣ ΚΑΙ ΤΙΣ ΛΟΙΠΕΣ ΣΧΕΤΙΚΕΣ ΔΙΑΤΑΞΕΙΣ ΤΗΣ ΟΔΗΓΙΑΣ 1999/5/ΕΚ.

### Eesti

Sellega kinnitab Kenwood, et see DNX7280BT, DNX5580BT, DNX5280BT, DNX4280BT vastab direktiivi 1999/5/EC põhilistele nõudmistele ja muudele asjakohastele määrustele.

### Latviešu

Ar šo, Kenwood, apstiprina, ka DNX7280BT, DNX5580BT, DNX5280BT, DNX4280BT atbilst Direktīvas 1999/5/EK galvenajām prasībām un citiem tās nosacījumiem.

### Lietuviškai

Šiuo, Kenwood, pareiškia, kad šis DNX7280BT, DNX5580BT, DNX5280BT, DNX4280BT atitinka pagrindinius Direktyvos 1999/5/EB reikalavimus ir kitas svarbias nuostatas.

### Malti

Hawnhekk, Kenwood, jiddikjara li dan DNX7280BT, DNX5580BT, DNX5280BT, DNX4280BT jikkonforma mal-htitjijiet essenzjali u ma provvedimenti oħrajn relevanti li hemm fid-Direttiva 1999/5/EC.

### Українська

Компанія Kenwood заявляє, що цей виріб DNX7280BT, DNX5580BT, DNX5280BT, DNX4280BT відповідає ключовим вимогам та іншим пов'язаним положенням Директиви 1999/5/EC.





---

**KENWOOD**