

# KENWOOD

BLU-RAY DISC PLAYER

## BD-7000

---

## INSTRUCTION MANUAL

Kenwood Corporation



**Declaration of Conformity with regard to  
the EMC Directive 2004/108/EC**

**Manufacturer:**

Kenwood Corporation  
2967-3 Ishikawa-machi, Hachioji-shi, Tokyo, 192-8525 Japan

**EU Representative's:**

Kenwood Electronics Europe BV  
Amsterdamsseweg 37, 1422 AC UITHOORN, The Netherlands



x.v.Colour





© TINS-E918WJQZ  
ORC9009-A

# OPERATION MANUAL

ENGLISH

Introduction

## SAFETY / IMPORTANT INFORMATION

	THE LIGHTNING FLASH WITH ARROWHEAD SYMBOL, WITHIN AN EQUILATERAL TRIANGLE, IS INTENDED TO ALERT THE USER TO THE PRESENCE OF UNINSULATED "DANGEROUS VOLTAGE" WITHIN THE PRODUCT'S ENCLOSURE THAT MAY BE OF SUFFICIENT MAGNITUDE TO CONSTITUTE A RISK OF ELECTRIC SHOCK TO PERSONS.
	THE EXCLAMATION POINT WITHIN AN EQUILATERAL TRIANGLE IS INTENDED TO ALERT THE USER TO THE PRESENCE OF IMPORTANT OPERATING AND MAINTENANCE (SERVICING) INSTRUCTIONS IN THE LITERATURE ACCOMPANYING THE APPLIANCE.

## Before Applying Power



 **Caution : Read this page carefully to ensure safe operation.**

Units are designed for operation as follows.

Europe .....AC 230 V only

## Safety precautions

**WARNING :** TO PREVENT FIRE OR ELECTRIC SHOCK, DO NOT EXPOSE THIS APPLIANCE TO RAIN OR MOISTURE.

	<b>CAUTION</b> RISK OF ELECTRIC SHOCK DO NOT OPEN	
CAUTION: TO REDUCE THE RISK OF ELECTRIC SHOCK, DO NOT REMOVE COVER (OR BACK). NO USER-SERVICEABLE PARTS INSIDE. REFER SERVICING TO QUALIFIED SERVICE PERSONNEL.		

### *The marking of products using lasers*



The marking this product has been classified as Class 1. It means that there is no danger of hazardous radiation outside the product.  
Location: Bottom

# DEAR Kenwood CUSTOMER

Thank you for your purchase of the Kenwood Blu-ray Disc/DVD Player. To ensure safety and many years of trouble-free operation of your product, please read the Important Safety Instructions carefully before using this product.

## IMPORTANT SAFETY INSTRUCTIONS

**⚠ Caution : Read this page carefully to ensure safe operation.**

### Read Instructions

– All the safety and operating instructions should be read before the product is operated.

### Retain Instructions

– The safety and operating instructions should be retained for future reference.

### Heed Warnings

– All warnings on the product and in the operating instructions should be adhered to.

### Follow Instructions

– All operating and use instructions should be followed.

**1. Cleaning** – Unplug this product from the wall outlet before cleaning. Do not use liquid cleaners or aerosol cleaners. Use a damp cloth for cleaning.

**2. Attachments** – Do not use attachments not recommended by the product manufacturer as they may cause hazards.

**3. Water and Moisture** – This product shall not be exposed to dripping and splashing – for example, near a bath tub, wash bowl, kitchen sink, or laundry tub; in a wet basement; or near a swimming pool; and the like. Do not place an object containing liquid, such as a flower vase, on the appliance.

**4. Accessories** – Do not place this product on an unstable cart, stand, tripod, bracket, or table. The product may fall, causing serious injury to a child or adult, and serious damage to the product. Use only with a cart, stand, tripod, bracket, or table recommended by the manufacturer. Any mounting of the product should follow the manufacturer's instructions, and should use a mounting accessory recommended by the manufacturer.

A product and cart combination should be moved with care. Quick stops, excessive force, and uneven surfaces may cause the product and cart combination to overturn.



**5. Ventilation** – Slots and openings in the cabinet are provided for ventilation and to ensure reliable operation of the product and to protect it from overheating, and these openings must not be blocked or covered. The openings should never be blocked by placing the product on a bed, sofa, rug, or other similar surface. This product should not be placed in a built-in installation such as a bookcase or rack unless proper ventilation is provided or the manufacturer's instructions have been adhered to.

**6. Power Sources** – This product should be operated only from the type of power source indicated on the product. If you are not sure of the type of power supply to your home, consult your product dealer or local power company.

**7. CAUTION – Polarization** – This product may be equipped with a polarized alternating-current line plug (a plug having one blade wider than the other). This plug will fit into the power outlet only one way. This is a safety feature. If you are unable to insert the plug fully into the outlet, try reversing the plug. If the plug should still fail to fit, contact your electrician to replace your obsolete outlet. Do not defeat the safety purpose of the polarized plug.

**8. Power Cord Protection** – Power-supply cords should be routed so that they are not likely to be walked on or pinched by items placed upon or against them, paying particular attention to cords at plugs, convenience receptacles, and the point where they exit from the product.

**9. Lightning** – For added protection for this product during a lightning storm, or when it is left unattended and unused for long periods of time, unplug it from the wall outlet and disconnect the antenna or cable system. This will prevent damage to the product due to lightning and power-line surges.

**10.Overloading** – Do not overload wall outlets, extension cords, or integral convenience receptacles as this can result in a risk of fire or electric shock.

**11.Object and Liquid Entry** – Never push objects of any kind into this product through openings as they may touch dangerous voltage points or short-out parts that could result in a fire or electric shock. Never spill liquid of any kind on the product.

**12.Servicing** – Do not attempt to service this product yourself as opening or removing covers may expose you to dangerous voltage or other hazards. Refer all servicing to qualified service personnel.

**13.Damage Requiring Service** – Unplug this product from the wall outlet and refer servicing to qualified service personnel under the following conditions:

- a) When the power-supply cord or plug is damaged,
- b) If liquid has been spilled, or objects have fallen into the product,
- c) If the product has been exposed to rain or water,
- d) If the product does not operate normally by following the operating instructions.
- e) If the product has been dropped or damaged in any way, and
- f) When the product exhibits a distinct change in performance – this indicates a need for service.
- g) If an abnormal smell or smoke is detected.

**14.Replacement Parts** – When replacement parts are required, be sure the service technician has used replacement parts specified by the manufacturer or have the same characteristics as the original part. Unauthorized substitutions may result in fire, electric shock, or other hazards.

# IMPORTANT SAFETY INSTRUCTIONS

**15. Safety Check** – Upon completion of any service or repairs to this product, ask the service technician to perform safety checks to determine that the product is in proper operating condition.

**16. Wall or Ceiling Mounting** – This product should be mounted to a wall or ceiling only as recommended by the manufacturer.

**17. Heat** – This product should be situated away from heat sources such as radiators, heat registers, stoves, or other products that produce heat. Do not place a flaming object, such as a candle or lantern, or near the product.

**18. Power Lines** – An outside antenna system should not be located in the vicinity of overhead power lines or other electric light or power circuits, or where it can fall into such power lines or circuits. When installing an outside antenna system, extreme care should be taken to keep from touching such power lines or circuits as contact with them might be fatal.

Notes:

Item 7 is not required except for grounded or polarized equipment.

## Information on Disposal of Old Electrical and Electronic Equipment and Batteries (applicable for EU countries that have adopted separate waste collection systems)



Products and batteries with the symbol (crossed-out wheeled bin) cannot be disposed as household waste.



Old electrical and electronic equipment and batteries should be recycled at a facility capable of handling these items and their waste byproducts.



**Pb**

Contact your local authority for details in locating a recycle facility nearest to you. Proper recycling and waste disposal will help conserve resources whilst preventing detrimental effects on our health and the environment.

Notice: The sign "Pb" below the symbol for batteries indicates that this battery contains lead.

## A. Information on Disposal for Users (private households)

### 1. In the European Union

Attention: If you want to dispose of this equipment, please do not use the ordinary dust bin!

Used electrical and electronic equipment must be treated separately and in accordance with legislation that requires proper treatment, recovery and recycling of used electrical and electronic equipment.

Following the implementation by member states, private households within the EU states may return their used electrical and electronic equipment to designated collection facilities free of charge\*. In some countries\* your local retailer may also take back your old product free of charge if you purchase a similar new one.

\*) Please contact your local authority for further details.

If your used electrical or electronic equipment has batteries or accumulators, please dispose of these separately beforehand according to local requirements.

By disposing of this product correctly you will help ensure that the waste undergoes the necessary treatment, recovery and recycling and thus prevent potential negative effects on the environment and human health which could otherwise arise due to inappropriate waste handling.

### 2. In other Countries outside the EU

If you wish to discard this product, please contact your local authorities and ask for the correct method of disposal.

For Switzerland: Used electrical or electronic equipment can be returned free of charge to the dealer, even if you don't purchase a new product. Further collection facilities are listed on the homepage of [www.swico.ch](http://www.swico.ch) or [www.sens.ch](http://www.sens.ch).

## B. Information on Disposal for Business Users

### 1. In the European Union

If the product is used for business purposes and you want to discard it:

Please contact your Kenwood dealer who will inform you about the take-back of the product. You might be charged for the costs arising from take-back and recycling. Small products (and small amounts) might be taken back by your local collection facilities.

For Spain: Please contact the established collection system or your local authority for take-back of your used products.

### 2. In other Countries outside the EU

If you wish to discard of this product, please contact your local authorities and ask for the correct method of disposal.

# Contents

## Introduction

<b>SAFETY / IMPORTANT INFORMATION</b> .....	<b>1</b>
<b>Before Applying Power</b> .....	<b>1</b>
<b>DEAR Kenwood CUSTOMER</b> .....	<b>2</b>
<b>IMPORTANT SAFETY INSTRUCTIONS</b> .....	<b>2-3</b>
<b>Contents</b> .....	<b>4-5</b>
<b>PRECAUTIONS</b> .....	<b>6</b>
<b>What would you like to do with this Player?</b> .....	<b>7</b>
<b>About Media Types</b> .....	<b>8-11</b>
Blu-ray Disc .....	8
Types of Discs that Can Be Used with This Player.....	8
Discs that Cannot Be Used with This Player.....	8
About Disc Contents.....	11
BD Video .....	11
Title, Chapter and Track.....	11
Icons Used on DVD Video Disc Cases .....	11
The Icons Used in This Operation Manual .....	11
<b>Important Information</b> .....	<b>12</b>
Disc Precautions .....	12
License and Copyright .....	12
<b>Getting Started</b> .....	<b>13</b>
<b>Major Components</b> .....	<b>14-15</b>
Main Unit (Front).....	14
Main Unit (Rear) .....	14
Remote Control Unit .....	15
<b>Player setup location</b> .....	<b>16</b>
Removing and replacing the terminal cover .....	16

## Connection

<b>Video Connection</b> .....	<b>17</b>
Connecting to the HDMI Terminal.....	17
<b>Audio Connection</b> .....	<b>18</b>
Connecting to the Digital Audio Terminal .....	18
<b>Broadband Internet Connection</b> .....	<b>19</b>
Internet Connection (LAN cable).....	19

## Playback

<b>Before Starting Playback</b> .....	<b>20-23</b>
Loading the Batteries in the Remote Control .....	20
Approximate operating range of remote control .....	20
Connecting the AC adapter.....	21
Turning the Power On .....	21
Turning the power on.....	21
Entering standby.....	21
Indicators on the Player .....	21
Language Setting.....	22
Changing the on-screen display language.....	22
Operating a SHARP TV Using the Remote Control.....	22
TV function control.....	22
Turning Off the Indicator Lights.....	22
Using HDMI CEC .....	23
Controlling the Blu-ray disc player using HDMI CEC .....	23
Using 3D.....	23

<b>Video/Picture/Music Playback</b> .....	<b>24-30</b>
Loading a Disc/Ejecting a Disc.....	24
BD/DVD Video Playback.....	24
Displaying the disc information.....	24
BD/DVD Menus .....	25
Start playback by selecting a title from the top menu .....	25
Using the disc menu .....	25
Using the pop-up menu .....	25
Enjoying BONUSVIEW or BD-LIVE .....	26
Use of Picture in Picture function (secondary audio/video playback).....	26
Virtual Package.....	26
BD-LIVE.....	26
DVD-R/-RW (VR format) / BD-RE/-R (BDAV format) Playback .....	27
Playback by selecting a title .....	27
Playback by selecting a Playlist.....	27
Audio CD Playback .....	28
Playback from the beginning .....	28
To skip the track during playback.....	28
Operation procedure for the "Functions" menu .....	28
Audio Data (MP3 File) Playback.....	29
Playing back Audio data (MP3 files) .....	29
To play another file during Playback .....	29
To skip the file during Playback .....	29
Displaying Still Images (JPEG files) .....	30
Displaying Still Images (JPEG files) .....	30
Playing back Slide Show .....	30
Setting slide show speed/repeat playback .....	30
<b>Playback Functions</b> .....	<b>31-33</b>
Fast Forward/Reverse (Search) .....	31
Skipping to the Next or the Start of the Current Chapter (Track/Title).....	31
Pause/Frame Advance Playback.....	31
Slow Playback .....	31
Skip Search .....	31
Replay .....	31
Repeat Playback of a Title or Chapter (Repeat Playback) .....	32
Partial Repeat Playback (Repeat Playback of a Specified Part) .....	32
Displaying the Audio Information .....	33
Switching Subtitles.....	33
Switching the Angle .....	33
Displaying the Angle Mark .....	33
<b>Settings During Playback</b> .....	<b>34-35</b>
Function Control .....	34
Function control operation procedure .....	34
Functions which can be set .....	35

# Settings

**SETTINGS..... 36-44**

- Common operations ..... 36
- Basic Operation for Playback Setting ..... 36
- Audio Video Settings..... 37
- Smart Settings ..... 38
- HDMI CEC ..... 38
- Playback Setting ..... 38
- On Screen Language ..... 39
- Version..... 39
- System ..... 39
- Communication Setup ..... 40-41
  - When using a LAN Cable ..... 40
  - The operation procedure for inputting characters manually..... 41
- USB Memory Management..... 42
- Software Update Settings ..... 43
  - Manual Update from USB memory device ..... 43
- Digital Audio Output Selection Formats ..... 44

# Appendix

**Troubleshooting..... 45-46**  
To Reset this Player..... 47

**On-screen Error Messages ..... 48**

**Specifications ..... 49**

**Glossary ..... 50-52**

**About Software License..... 53**

## What to do first:

Refer to "Getting Started" (p. 13) to prepare for using this player.

## Introduction (pp. 1–16)

Explains the important operation information.

## Connection (pp. 17–19)

Shows the connecting options provided by this Player.

## Playback (pp. 20–35)

Shows simple playback and useful functions.

## Settings (pp. 36-44)

Gives you more options to suit your circumstances.

## Appendix (pp. 45-53)

Provides troubleshooting tips and more information.

**The illustrations and on-screen displays in this operation manual are for explanation purposes and may vary slightly from the actual operations.**

# PRECAUTIONS

---

## **Precautions on viewing stereoscopic 3D images**

- Do not view stereoscopic 3D images if you have a history of photosensitivity, heart disease or poor health. This may cause the symptoms to worsen.
- If you experience any health problems such as fatigue and discomfort while viewing stereoscopic 3D images, immediately discontinue viewing. Continuing viewing after symptoms appear may cause health risks. Take a break until the symptoms have completely disappeared.
- Ages of 5–6 or over are recommended for viewing stereoscopic 3D images. Symptoms such as fatigue and discomfort are difficult to determine in young children, therefore they may suddenly become ill. When viewing 3D images with children, please watch for eye strain symptoms.
- When viewing stereoscopic 3D images, take a moderate break after watching one title. Viewing for extended periods may cause visual strain.

## **Precautions when cleaning this product**

- Turn off the main power and unplug the AC cord from the wall outlet before handling.
- To clean the outer cabinet, periodically wipe it with a soft cloth (cotton, flannel, etc.).
- For severe dirt, soak a soft cloth (cotton, flannel, etc.) in some neutral detergent diluted with water, wring the cloth out thoroughly, wipe off the dirt, then wipe again with a soft, dry cloth.
- Do not use chemicals or a chemically treated cloth for cleaning. It may damage the cabinet finish.

# What would you like to do with this Player?

## Watch high quality movies on Blu-ray discs

This Player offers full high-definition Blu-ray disc playback.

**Video/Picture/Music Playback (p. 24)**

## Enjoy stereoscopic and powerful 3D images

This player can play 3D content from 3D compatible Blu-ray discs through an HDMI cable. To watch 3D images, connect a 3D compatible TV to this player using an HDMI cable and play the 3D content while wearing 3D glasses.

**Using 3D (p. 23)**

## Enjoy different kinds of media sources

Use this player to enjoy video, picture or music content from various types of media sources such as DVDs, USB memory devices and via the Internet.

**About Media Types (pp. 8–11)  
Video/Picture/Music Playback (p. 24)**

## Simple connection and operation through HDMI

This Player is equipped with an HDMI terminal. You can connect it to the TV using HDMI and no other cable will be needed to enjoy movies. If your TV is compatible with HDMI CEC, you can control both the TV and this Player with simple operations.

**Video Connection (p. 17)**

## Enjoy BD-LIVE functions through the Internet

This Player is compatible with BD-LIVE. You can enjoy bonus content such as movie trailers through the Internet when playing back BD-Video discs compatible with BD-LIVE.

**Enjoying BONUSVIEW or BD-LIVE (p. 26)**



# About Media Types



## Blu-ray Disc

Blu-ray Disc is the ultimate next generation optical media format, offering the following key features:

- Largest capacity (25 GB single layer – 50 GB dual layer) – with over 5 times the amount of content possible with current DVDs, particularly well suited for high definition feature films with extended levels of interactive features
- Pristine picture quality with the capability for full high definition 1920 x 1080p resolution
- Best audio possible with uncompressed surround sound (higher quality than even theatre audio)
- Broadest industry support – ensuring more choice for consumers in the marketplace
- Hardware products will be backward compatible with DVDs, allowing continued enjoyment of existing DVD libraries.
- Disc Durability – new breakthroughs in hard coating technologies gives Blu-ray Discs the strongest resistance to scratches and finger prints.

## Types of Discs that Can Be Used with This Player

- The following discs can be played back in this Player. Do not use an 8 cm to 12 cm adapter.
- Use discs that conform to compatible standards as indicated by the presence of official logos on the disc label. Playback of discs not complying with these standards is not guaranteed. In addition, the image quality or sound quality is not guaranteed even if the discs can be played back.

Disc Type		Recording Format	Contents	Disc Size
BD Video	Region code B/ALL 	—	Audio + Video (Movie)	12 cm
	BD-RE DL BD-R DL	BDMV/BD-RE format		
DVD Video	Region code 2/ALL 	Video format	Audio + Video (Movie)	12 cm 8 cm
	DVD+RW/DVD+R DVD-RW/DVD-R DVD+R DL/DVD-R DL	Video/VR/AVCHD format (finalised disc only)	Audio + Video (Movie)	
		DivX		12 cm 8 cm
		JPEG*2	Still image (JPEG file)	
		MP3*3	Audio	
Audio CD*1		Audio CD (CD-DA)	Audio	12 cm 8 cm
CD-RW/CD-R		Audio CD (CD-DA)	Audio	
		JPEG*2	Still image (JPEG file)	
		MP3*3	Audio	
		DivX	Audio + Video (Movie)	

- BD/DVD video players and discs have region codes, which dictate the regions in which a disc can be played. This Player's region code is **B** for BD and **2** for DVD. (Discs marked **ALL** will play in any player.)
- BD/DVD video operations and functions may be different from the explanations in this manual and some operations may be prohibited due to disc manufacturer's settings.
- If a menu screen or operating instructions are displayed during playback of a disc, follow the operating procedure displayed.
- The audio component of a DVD video recorded at 96 kHz (Linear PCM) will be output as 48 kHz audio during playback.

### NOTE

- Playback for some of the discs in the left side column tables may not be possible depending on the disc.
- "Finalise" refers to a recorder processing a recorded disc so that it will play in other DVD players/recorders as well as this player. Only finalised DVD discs will play back in this player. (This player does not have a function to finalise discs.)
- Some discs cannot be played back depending on the recording format.

## Discs that Cannot Be Used with This Player

The following discs cannot be played back or will not play back properly on this Player. If such a disc is mistakenly played back, speaker damage may occur. Never attempt to play back these discs.

CDG, Video CD, Photo CD, CD-ROM, CD-TEXT, SVCD, SACD, PD, CDV, CVD, DVD-RAM, DVD-Audio, BD-RE with the cartridge, CD-WMA

### Discs with unusual shapes cannot be played.

- Discs with unusual shapes (heart-shaped or hexagonal discs, etc.) cannot be used. The use of such discs will cause malfunction.

### The following BD video discs cannot be played.

- Discs not displaying "B" or "ALL" for the region code (discs sold outside the authorised marketing area).\*
  - Discs produced illegally.
  - Discs recorded for commercial use.
- \* The region code for this product is B.

### The following DVD video discs cannot be played.

- Discs not displaying "2" or "ALL" for the region code (discs sold outside the authorised marketing area).\*
  - Discs produced illegally.
  - Discs recorded for commercial use.
- \* The region code for this product is 2.

## About Media Types

### The following BD-RE/R, DVD-RW/R and DVD+RW/R discs cannot be played.

- Discs on which data has not been recorded cannot be played back.
- Kenwood cannot guarantee playback compatibility for all self-recorded BD-discs because Blu-ray is a new and evolving format. The playback compatibility will be affected by your choice of BD-recorder, BD-disc and BD-burning software. Please always ensure you are using the latest software versions on all units and contact the individual manufacturers for further help if required.

To avoid inconveniences, please check the playback compatibility of your self-recorded disc before you purchase this BD-player. For maximum playback compatibility of self-recorded BD-discs Kenwood recommends that the BDMV/BDAV standards are used. If a playback issue occurs after purchase, please download the latest software version for your BD-player from the Kenwood internet page or ask your Kenwood-Dealer. This BD-player uses the latest technology available at the time of development and cannot guarantee support for future enhancements or changes to the standard.

### The following Audio CD<sup>1</sup> discs cannot be played.

- Discs containing a signal for the purpose of protecting copyrights (copy control signal) may not be played back with this Player.
- This Player has been designed on the premise of playing back Audio CDs that comply with CD (Compact Disc) standards.

### The following CD-RW/R discs cannot be played.

- Discs on which data has not been recorded cannot be played back.
- Discs recorded in a format other than an Audio CD and JPEG/MP3 file format cannot be played back.
- Discs may not be played back depending on their recording status or the status of the disc itself.
- Discs may not be played back depending on their compatibility with this Player.

### \*2 About the JPEG file format

JPEG is a type of file format for storing still-image files (photos, illustrations, etc.). The Player lets you play JPEG format still-image files.

#### File formats that are not compatible.

- Still images in formats other than JPEG (such as TIFF) cannot be played.
- There may be some files that cannot be played even if they are in JPEG format.
- Progressive JPEG files cannot be played.
- Moving image files as well as Motion JPEG format files cannot be played, even though they are JPEG files.

#### Other files that cannot be played back.

- You may not be able to play some still images which you have created, touched up, copied or otherwise edited on your computer.
- You may not be able to play some still images you have processed (rotated or saved by overwriting other images you have imported from the Internet or e-mail).

#### You may experience one or more of the following symptoms when playing files.

- It may take some time to play files depending on the number of folders, number of files and volume of data involved.
- EXIF information will not be displayed. EXIF stands for Exchangeable Image File Format, and is a standard for storing interchange information in image files, especially those using JPEG compression. (Refer to <http://exif.org> for more information.)

### \*3 About the MP3 file format

MP3 files are audio data compressed in the MPEG1/2 Audio layer-3 file format. "MP3 files" have ".mp3" as extensions. (Some files that have ".mp3" extensions or files that have not been recorded in MP3 format will produce noise or cannot be played.)

#### Playing the MP3 file format

- The MP3 files are not played in the order they were recorded.
- It is recommended to record data at a lower speed as data recorded at a fast speed can produce noise and may not be able to be played.
- The more folders there are, the longer the reading time.
- Depending on the folder tree, reading MP3 files can take time.
- The playing time may not be correctly displayed during MP3 file playback.

#### The following files cannot be played on this player.

- When both Audio CD [CD-DA] format and JPEG/MP3 file formats are recorded on a disc. (The disc is recognised to be an Audio CD [CD-DA] only tracks in Audio CD [CD-DA] format are played back.)
- Multi-session discs cannot be played.

## About Media Types

### About files/folders for Still images (JPEG files) and audio data (MP3 files)

You can play still images (JPEG files) /audio data (MP3 files) with this unit by making folder(s) on discs or USB memory devices as shown below.

Example of a folder structure:

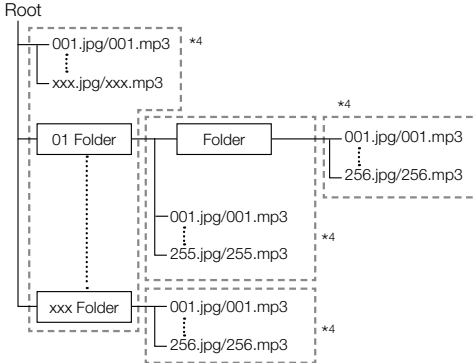

\*4 Including the root directory, the maximum number of folders and files in each folder is limited to 256 in total.

### File and folder requirements

- The discs or USB memory devices which this player can play back (recognise) are limited to the following properties:
  - Contains EXIF format files (only JPEG files)
  - Picture resolution: Between 32 x 32 and 6528 x 3672 pixels (only JPEG files)
  - Maximum number of folders and files in each folder: 256
  - Maximum hierarchy level of folders: 5
  - File size: 8 MB or less (JPEG files)
  - 200 MB or less (MP3 files)

### NOTE

- File and folder names displayed on this player may differ from those displayed on PCs.

### About DivX VIDEO

DivX® is a digital video format created by DivX, Inc. This is an official DivX Certified device that plays DivX video. Visit [www.divx.com](http://www.divx.com) for more information and software tools to convert your files into DivX video.

### About DivX VIDEO-ON-DEMAND

This DivX Certified® device must be registered in order to play DivX Video-on-Demand (VOD) content. To generate the registration code, locate the DivX VOD section in the device setup menu. Go to [vod.divx.com](http://vod.divx.com) with this code to complete the registration process and learn more about DivX VOD.

## About Media Types

### About Disc Contents

#### BD Video

Enjoy BD-specific functions including BONUSVIEW (BD-ROM Profile 1 Version 1.1), such as picture-in-picture, and BD-LIVE (Page 26).

For the BD video discs compatible with BONUSVIEW/BD-LIVE, you can enjoy additional contents by copying the data from the discs or downloading it via the Internet. For instance, this function is capable of playing the original movie as the primary video while playing video commentary from the film director on a small screen as a secondary video.

**NOTE**

- The available functions differ depending on the disc.

#### Title, Chapter and Track

- Blu-ray discs and DVDs are divided into "Titles" and "Chapters". If the disc has more than one movie on it, each movie would be a separate "Title". "Chapters", on the other hand, are subdivisions of titles. (See Example 1.)
- Audio CDs are divided into "Tracks". You can think of a "Track" as one tune on an Audio CD. (See Example 2.)

Example 1: Blu-ray disc or DVD

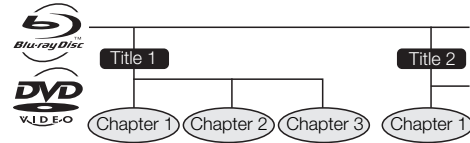

Example 2: Audio CD



#### Icons Used on DVD Video Disc Cases

The back of the case of a DVD that is commercially available usually contains various information about the contents of the disc.

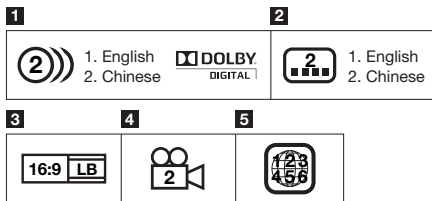

#### 1 Audio tracks and audio formats

DVD discs can contain up to 8 separate tracks with a different language on each. The first in the list is the original track.

This section also details the audio format of each soundtrack — Dolby Digital, DTS, MPEG etc.

#### Dolby Digital

A sound system developed by Dolby Laboratories Inc. that gives movie theatre ambience to audio output when the Player is connected to a Dolby Digital processor or amplifier.

#### DTS

DTS is a digital sound system developed by DTS, Inc. for use in cinemas.

#### Linear PCM

Linear PCM is a signal recording format used for Audio CDs and on some DVD and Blu-ray discs. The sound on Audio CDs is recorded at 44.1 kHz with 16 bits. (Sound is recorded between 48 kHz with 16 bits and 96 kHz with 24 bits on DVD video discs and between 48 kHz with 16 bits and 192 kHz with 24 bits on BD video discs.)

#### 2 Subtitle languages

This indicates the kind of subtitles.

#### 3 Screen aspect ratio

Movies are shot in a variety of screen modes.

#### 4 Camera angle

Recorded onto some BD/DVD discs are scenes which have been simultaneously shot from a number of different angles (the same scene is shot from the front, from the left side, from the right side, etc.).

#### 5 Region code

This indicates the region code (playable region code).

### The Icons Used in This Operation Manual

- BD VIDEO** ..... Indicates the functions that can be performed for BD Video discs.
- BD-RE** ..... Indicates the functions that can be performed for BD-RE discs.
- BD-R** ..... Indicates the functions that can be performed for BD-R discs.
- DVD VIDEO** ..... Indicates the functions that can be performed for DVD Video discs.
- DVD-RW** ..... Indicates the functions that can be performed for DVD-RW discs.
- DVD-R** ..... Indicates the functions that can be performed for DVD-R discs.
- AUDIO CD** ..... Indicates the functions that can be performed for Audio CDs.
- CD-R** ..... Indicates the functions that can be performed for CD-R discs.
- CD-RW** ..... Indicates the functions that can be performed for CD-RW discs.
- USB** ..... Indicates the functions that can be performed for USB memory devices.





# Important Information

## Disc Precautions

### Be Careful of Scratches and Dust

- BD, DVD and CD discs are sensitive to dust, fingerprints and especially scratches. A scratched disc may not be able to be played back. Handle discs with care and store them in a safe place.

### Proper Disc Storage

Place the disc in the centre of the disc case and store the case and disc upright.	
Avoid storing discs in locations subject to direct sunlight, close to heating appliances or in locations of high humidity.	
Do not drop discs or subject them to strong vibrations or impacts.	
Avoid storing discs in locations where there are large amounts of dust or moisture.	

### Handling Precautions

- If the surface is soiled, wipe gently with a soft, damp (water only) cloth. When wiping discs, always move the cloth from the centre hole toward the outer edge.



- Do not use record cleaning sprays, benzene, thinner, static electricity prevention liquids or any other solvent.
- Do not touch the surface.
- Do not stick paper or adhesive labels to the disc.
- If the playing surface of a disc is soiled or scratched, the Player may decide that the disc is incompatible and eject the disc, or it may fail to play the disc correctly. Wipe any dirt off the playing surface with a soft cloth.

### Cleaning the Pick Up Lens

- Never use commercially available cleaning discs. The use of these discs can damage the lens.

### Warnings about dew formation

- Condensation may form on pick up lens or disc in the following conditions:
  - Immediately after a heater has been turned on.
  - In a steamy or very humid room.
  - When the Player is suddenly moved from a cold environment to a warm one.

#### When condensation forms:

- It becomes difficult for the Player to read the signals on the disc and prevents the Player from operating properly.

#### To remove condensation:

- Take out the disc and leave the Player with the power off until the condensation disappears. Using the Player when there is condensation may cause malfunction.

## License and Copyright

Audio-visual material may consist of copyrighted works which must not be recorded without the authority of the owner of the copyright. Refer to relevant laws in your country.

- "This item incorporates copy protection technology that is protected by U.S. patents and other intellectual property rights of Rovi Corporation. Reverse engineering and disassembly are prohibited."
- Manufactured under license from Dolby Laboratories. "Dolby" and the double-D symbol are trademarks of Dolby Laboratories.
- Manufactured under license under U.S. Patent #'s: 5,451,942; 5,956,674; 5,974,380; 5,978,762; 6,226,616; 6,487,535; 7,392,195; 7,272,567; 7,333,929; 7,212,872 & other U.S. and worldwide patents issued & pending. DTS and the Symbol are registered trademarks, & DTS-HD, DTS-HD Master Audio | Essential and the DTS logos are trademarks of DTS, Inc. Product includes software. ©DTS, Inc. All Rights Reserved.
-  is a trademark.
- "BD-LIVE" logo is a trademark of Blu-ray Disc Association.
-  is a trademark of DVD Format/Logo Licensing Corporation.
- HDMI, the HDMI logo and High-Definition Multimedia Interface are trademarks or registered trademarks of HDMI Licensing LLC.
- "x.v.Colour" and "x.v.Colour" logo are trademarks of Sony Corporation.
- Java and all Java-based trademarks and logos are trademarks or registered trademarks of Sun Microsystems, Inc. in the United States and/or other countries.
- "BONUSVIEW" logo is a trademark of Blu-ray Disc Association.
- "AVCHD" and the "AVCHD" logo are trademarks of Panasonic Corporation and Sony Corporation.
- "Blu-ray 3D" and "Blu-ray 3D" logo are trademarks of Blu-ray Disc Association.
- DivX®, DivX Certified® and associated logos are registered trademarks of DivX, Inc. and are used under license.

# Getting Started

## Step 1: Unpacking

Make sure the following accessories are provided with the product.

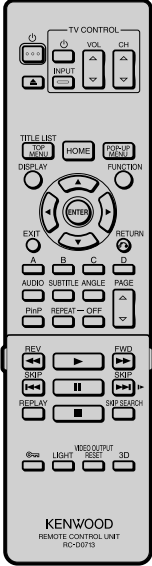
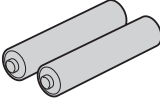
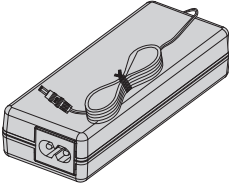
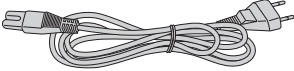
Remote control unit (RC-D0713)	“AAA” size battery (×2)	AC cord
 <p data-bbox="184 898 317 919">Pages 15 and 20</p>	 <p data-bbox="543 537 603 558">Page 20</p>  <p data-bbox="543 898 603 919">Page 21</p>	 <p data-bbox="870 537 931 558">Page 21</p>

**WARNING:** The AC adapter and AC cord supplied with this player must not be used with other equipment. AC adapters and AC cords other than the ones supplied must not be used with this player.

## Step 2: Selecting equipment to connect

Connection varies with the equipment used. Refer to Connection (Pages 17–19). Turn off the devices before connecting.

### Enjoying BD-LIVE

To enjoy BD-LIVE content on your TV, after an Internet connection is made, communication setup is required. Refer to “Communication Setup” (Pages 40–41).

## Step 3: Playing back video/picture/music content

Play back video, picture or music content from the desired media source such as Blu-ray and DVD discs. Refer to Playback (Pages 20–35).

## Step 4: Adjust settings to suit your preference

Adjust settings to enjoy various features and other functions for playing discs/content. Refer to Settings (Pages 36–44).

# Major Components

## Main Unit (Front)

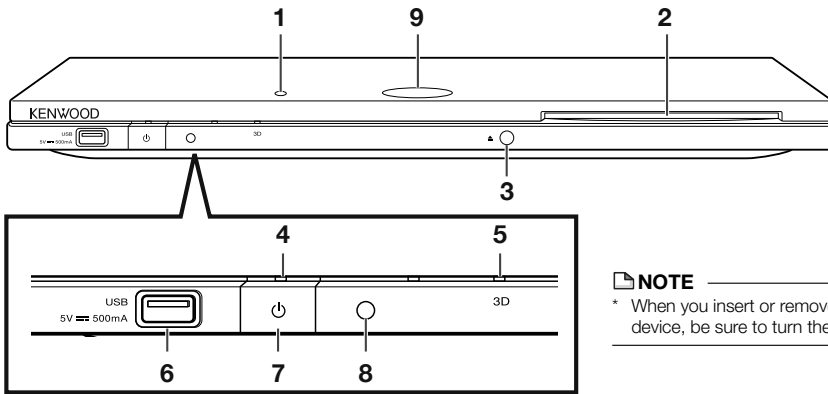

### NOTE

\* When you insert or remove a USB memory device, be sure to turn the main power off.

- |                               |                                  |                                 |
|-------------------------------|----------------------------------|---------------------------------|
| 1 Remote control sensor "TOP" | 4 (On/Standby) indicator (p. 21) | 7 (On/Standby) (p. 21)          |
| 2 Disc slot (p. 24)           | 5 3D indicator (pp. 21, 23)      | 8 Remote control sensor "FRONT" |
| 3 (p. 24)                     | 6 USB terminal (p. 29)           | 9 Keylock indicator             |

## Main Unit (Rear)

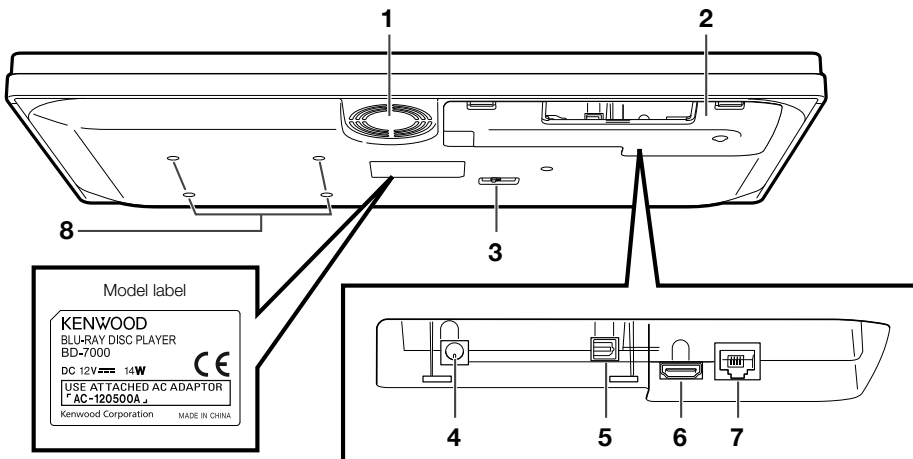

- |  |   |
|--|---|
| 1 Cooling fan<br>The cooling fan operates while the power to the Player is on. | 5 OPTICAL DIGITAL OUT terminal (p. 18)  |
| 2 Terminal cover (p. 16)   | 6 HDMI OUT terminal (p. 17)   |
| 3 Selector switch for Remote control sensor ("TOP"/ "FRONT")                   | 7 ETHERNET terminal (p. 19)   |
| 4 DC IN terminal (p. 21)   | 8 Screw holes for VESA 75 Mount<br>Screw size: M4 (Maximum length = Mount plate thickness + 6 mm)<br>Recommended tightening torque for M4 screws: 1.2±0.1N·m (12.2±1kgf·cm) |

### NOTE

• Some optical and/or HDMI cables may not fit in the compartment.

Remote Control Unit

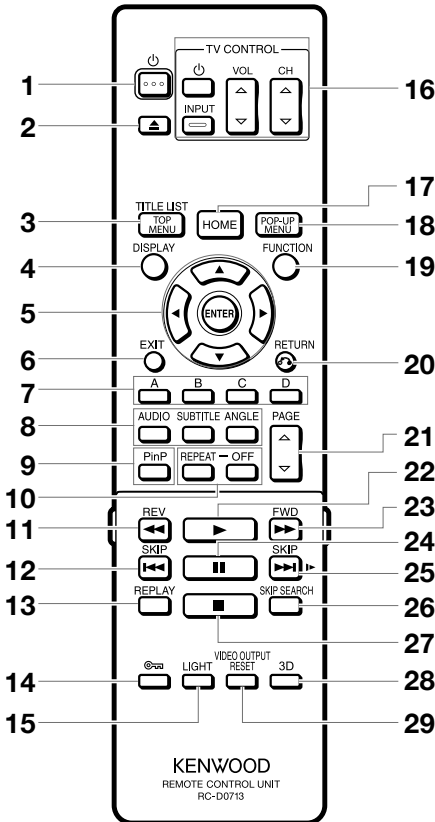

- 1 ⏻ (On/Standby) (p. 21)
- 2 ▲ (p. 24)
- 3 TOP MENU/TITLE LIST (pp. 25, 27)
- 4 DISPLAY (pp. 24, 32)
- 5 Cursor buttons (▲/▼/◀/▶), ENTER (pp. 22, 36)
- 6 EXIT (p. 36)
- 7 A (Red), B (Green), C (Yellow), D (Blue) (pp. 27, 28, 30, 41)
- 8 AUDIO (p. 33), SUBTITLE (p. 33), ANGLE (p. 33)
- 9 PinP (p. 26)
- 10 REPEAT (p. 32), OFF (for REPEAT) (p. 32)
- 11 ◀◀ REV (p. 31)
- 12 ◀◀ SKIP (pp. 27, 31)
- 13 REPLAY (p. 31)
- 14 🔒 (Lock) (See below.)
- 15 LIGHT (p. 22)
- 16 TV CONTROL buttons (p. 22)
- 17 HOME (pp. 22, 36)
- 18 POP-UP MENU (p. 25)
- 19 FUNCTION (p. 34)
- 20 ⏪ RETURN (pp. 28, 32)
- 21 PAGE ▲/▼ (p. 27)
- 22 ▶ (Play) (p. 24)
- 23 ▶▶ FWD (p. 31)
- 24 || (pp. 29, 31)
- 25 ▶▶ SKIP/▶ (pp. 27, 31)
- 26 SKIP SEARCH (p. 31)
- 27 ■ (p. 24)
- 28 3D (p. 23)
- 29 VIDEO OUTPUT RESET (p. 37)
- 30 Number buttons (p. 35)
- 31 ENTER (p. 35)

This button is the same operation as 5 ENTER.

**32 CLEAR** (p. 40)  
To clear the input number.

**33 Non-functional buttons**  
They have no operation at all.  
These buttons on the remote control are non-functional.

Buttons under the cover

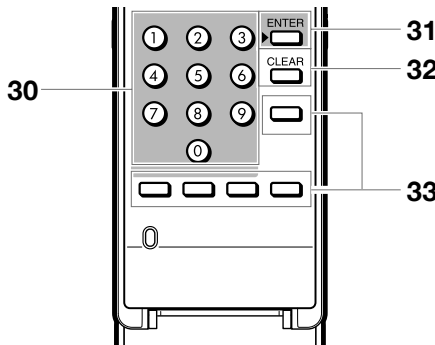

**NOTE**

- This remote control unit is equipped with two **ENTER** buttons (5 and 31 listed above). The **ENTER** button under the cover is useful when using with the number buttons.

**Keylock function**

You can set the keylock to prevent accidental operations. This function allows TVs compatible with HDMI CEC to also perform a Key Lock on the player. Press and hold 🔒 (Lock) for more than 2 seconds.

- Each time you perform this operation, the function is activated or deactivated. In such cases, the Keylock indicator blinks.
- When operating the player in a status where the keylock functions is set, the Keylock indicator will blink for approximately 2 seconds.

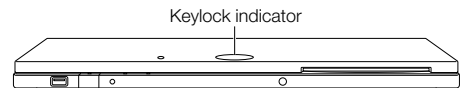



# Player setup location

## Removing and replacing the terminal cover

Before connecting the player to a TV, the AC adapter, etc., remove the terminal cover on the bottom of the player.

- 1 Remove the terminal cover on the bottom of the player.

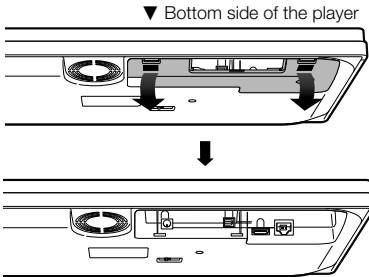

- 2 Make the necessary connections to the player (Pages 17–19, 21).
- 3 Replace the terminal cover.

### ● Using the player in a horizontal position

Pass the cables through the centre of the terminal cover.

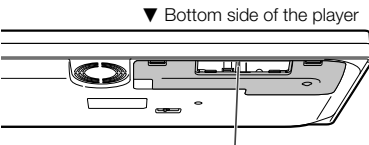

Pass the cables through here.

Replace the terminal cover so the cables pass through the centre of the cover.

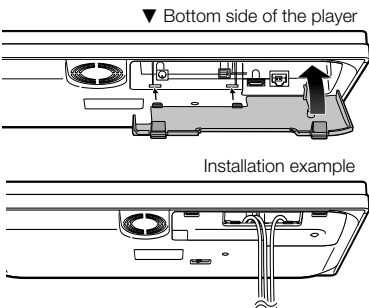

## Securing bracket for the HDMI cable

The terminal cover has a securing bracket to prevent breakage of the HDMI cable. When the HDMI cable is not passed straight through the securing bracket, the terminal cover cannot be closed.

- ▼ Back of the terminal cover

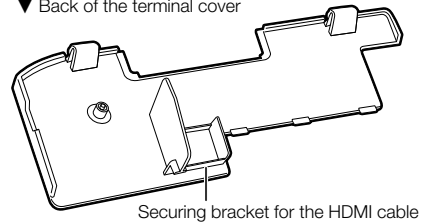

## Installation precautions

Always install the system on a level, stable surface. When installing on a stand or tabletop, be sure to confirm the strength of the stand.

The magnetism from the speakers may cause color irregularities on a nearby TV or PC screen. Always install the speakers at a distance from a TV or PC.

### ⚠ CAUTION

Observe the following cautions when installing the system (Main unit and AC adaptor). Insufficient heat radiation may build up internal heat and cause a malfunction or fire hazard.

- Do not place an object that may hinder heat radiation on the system.
- Do not install the system on the back, on the side or upside down.
- Do not place a cloth on the system or place it on a carpet or cushion.
- Do not use the system in a poorly ventilated place.

## Malfunction of the system

If the system does not function properly or the display shows erroneous information even when the connections are made correctly, reset the system (Page 47).

# Video Connection

## Connecting to the HDMI Terminal

- You can enjoy high quality digital picture and sound through the HDMI terminal.
- When you use HDMI CEC, make sure to use a certified HDMI cable.
- For details on digital audio output formats (PCM/bitstream), refer to the digital audio output format selection table on page 44.

**STEPS**

- 1 Be sure to turn off this Player and the equipment before making any connections.**
- 2 Firmly connect an HDMI cable (commercially available) to the HDMI terminals (① and ②).**

**NOTE**

- Audio transmitted in DTS-HD High Resolution Audio and DTS-HD Master Audio formats is output from the HDMI terminal as Bitstream. Connect an amplifier with a built-in decoder to enjoy the fine sound quality.

- When using an HDMI output, 7.1 ch Digital Output is available.

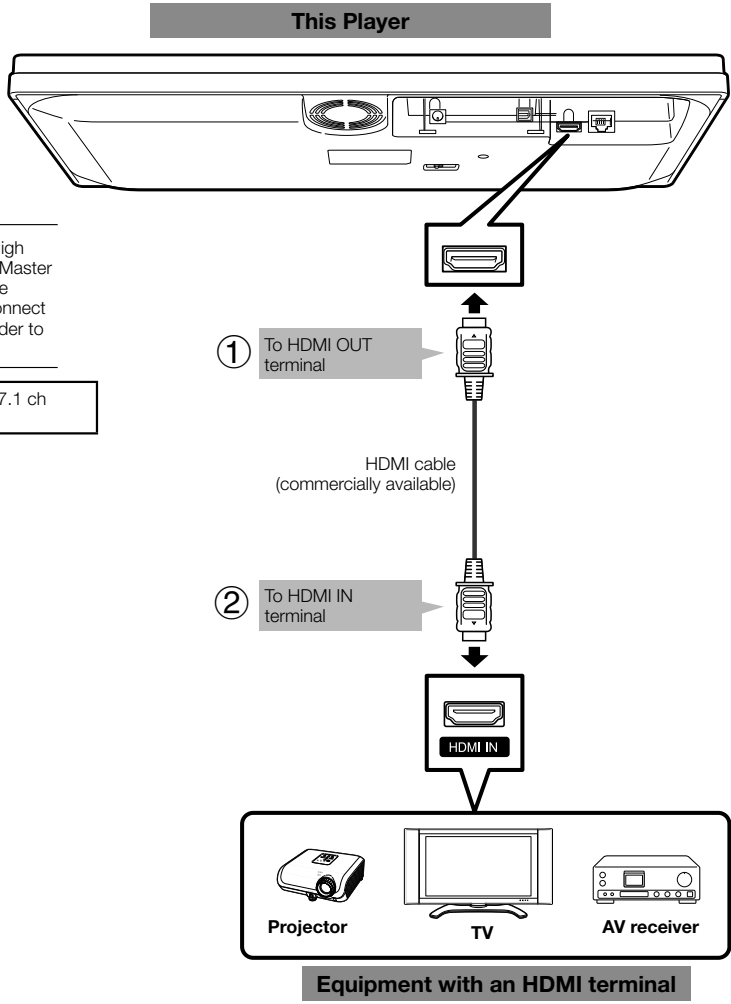

Connection

**After connecting**

- If desired, connect audio equipment. (Page 18)
- If necessary, perform the Audio Video Settings. (Page 37)
- Refer to HDMI CEC function. (Pages 23 and 38)
- Prepare the desired disc or content and start playback. (Pages 24–30)

# Audio Connection

## Connecting to the Digital Audio Terminal

- You can connect audio equipment or the TV to the OPTICAL DIGITAL OUT terminal.
- For details on digital audio output formats (PCM/bitstream), refer to the digital audio output format selection table on page 44.

### STEPS

- 1 Be sure to turn off this Player and the equipment before making any connections.
- 2 Firmly connect an optical digital cable (commercially available) to the optical digital audio terminals (① and ②).

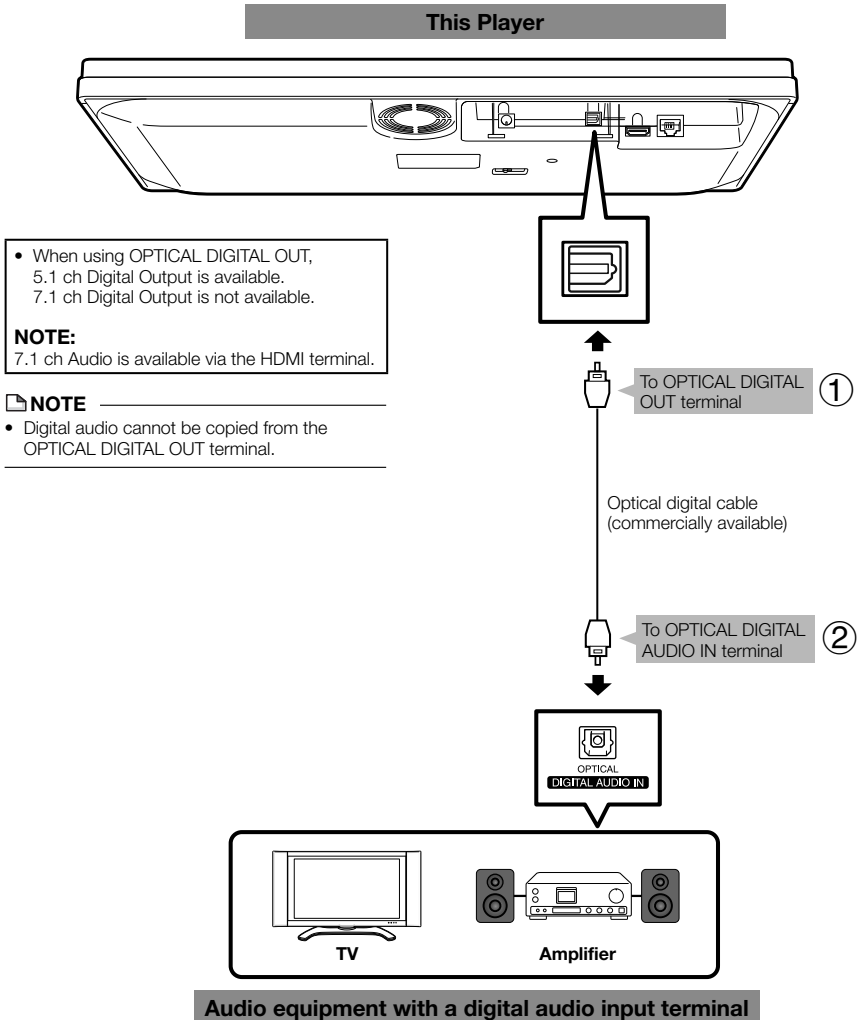

### After connecting

- If necessary, perform the Audio Video Settings. (Page 37)
- Prepare the desired disc or content and start playback. (Pages 24–30)

# Broadband Internet Connection

## Internet Connection (LAN cable)

- By connecting this player to the Internet, you can enjoy a variety of content on your TV using BD-LIVE functions and also perform software updates.
- When using the Internet, a broadband Internet connection as shown below is required.

### STEPS

- 1 Be sure to turn off this Player and the equipment before making any connections.
- 2 Firmly connect a LAN cable (commercially available) to the ETHERNET terminal (① and ②).

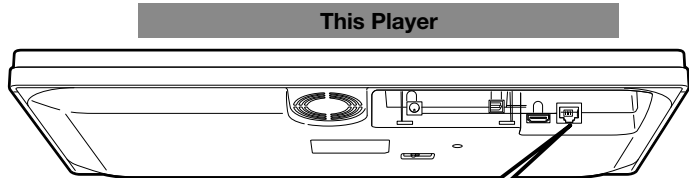

### CAUTION

- When using a broadband Internet connection, a contract with an Internet service provider is required. For more details, contact your nearest Internet service provider.
- Refer to the operation manual of the equipment you have as the connected equipment and connection method may differ depending on your Internet environment.

### NOTE

- Use a LAN cable/router supporting 10BASE-T/100BASE-TX.
- Kenwood cannot guarantee that all brands' hubs will operate with this player.

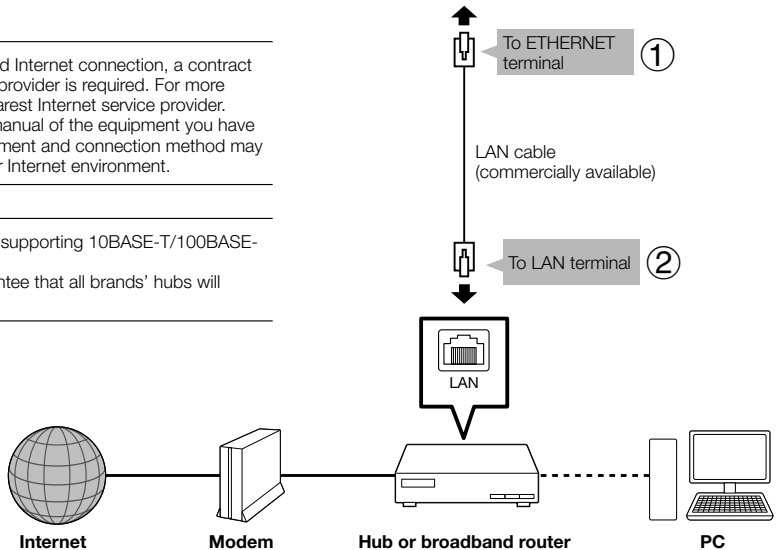

### Example of a Broadband Internet Connection

### After connecting

- Perform the communication settings. (Pages 40–41)
- When enjoying content on your TV using BD-LIVE functions, refer to BD-LIVE (Pages 26 and 39).

# Before Starting Playback

## Loading the Batteries in the Remote Control

- 1 Hold in the tab on the battery cover and pull the cover towards the direction of the arrow.

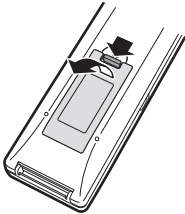

- 2 Load the two "AAA" size batteries (R-03 size, UM/SUM-4). Place batteries with their terminals corresponding to the  $\oplus$  and  $\ominus$  indications in battery compartment.

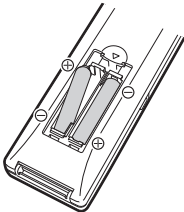

- 3 Insert the smaller tab of the battery cover into the opening ①, and press down on the cover until it clicks in place ②.

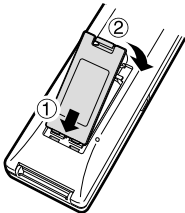

### NOTE

- Do not subject the remote control unit to shock, water or excessive humidity.
- The remote control unit may not function if the Player's remote sensor is in direct sunlight or any other strong light.
- Incorrect use of batteries may cause them to leak or burst. Read the battery warnings and use the batteries properly.
- Do not mix old and new batteries, or mix different brands.
- Remove the batteries if you will not use the remote control unit for an extended period of time.

### CAUTION

- Do not use or store batteries in direct sunlight or other excessively hot place, such as inside a car or near a heater. This can cause batteries to leak, overheat, explode or catch fire. It can also reduce the life or performance of batteries.

## Approximate operating range of remote control

You can select the remote control sensor used depending on the orientation of the player.

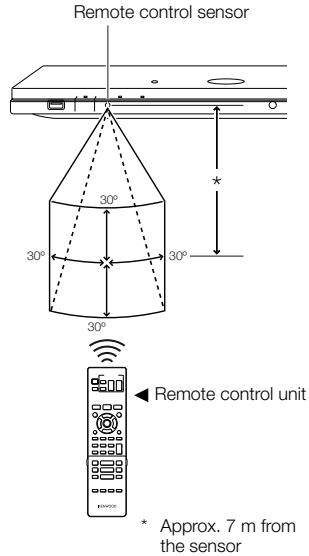

## Before Starting Playback

### Connecting the AC adapter

- ① Plug the AC adapter cord in to the DC IN terminal on the rear of the Player.
- ② Plug the supplied AC cord into the AC adapter.
- ③ Then, plug into an AC outlet.

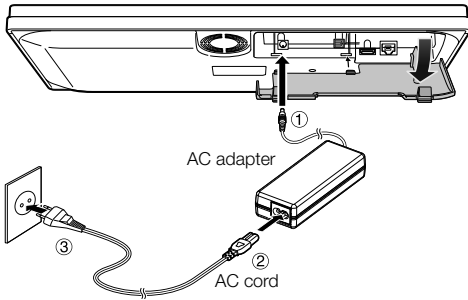

#### ⚠ CAUTION

- Use the AC adapter (AC-120500A) provided with this product.

#### 📄 NOTE

- Place the Player close to the AC outlet, and keep the power plug within reach.
- TO PREVENT RISK OF ELECTRIC SHOCK, DO NOT TOUCH THE UN-INSULATED PARTS OF ANY CABLES WHILE THE AC CORD IS CONNECTED.
- The AC adapter may become warm after long-time use. This is normal and does not indicate malfunction.
- If you are not going to use this Player for a long period of time, be sure to remove the AC cord from the AC outlet.

### Turning the Power On

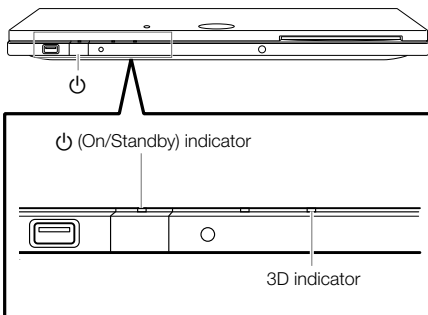
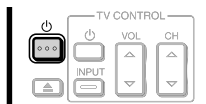

### Turning the power on

Press on the remote control or on the Player to turn on the power of the Player.

- The (On/Standby) indicator lights green.

#### 📄 NOTE

- When you turn on this player for the first time after purchase or when you turn on this player after you perform "System Reset" (See page 39), the language setting screen will be displayed, so please perform the language setting (See step 4 of page 22).

### Entering standby

Press on the remote control or on the Player to enter standby.

The system is using very weak current to maintain the built-in memory. This is called Standby mode. When system main unit is in this mode, you can turn it on using the remote control.

- The (On/Standby) indicator lights red.
- If you press again immediately after entering standby, the Player may not turn on. If this happens, wait for 10 seconds or more and then turn on the power again.

### Indicators on the Player

#### (On/Standby) indicator

Green on	Power on
Red on	Standby

#### 3D indicator

Green on	Video signal output is 3D images (See page 23).
----------	---

#### ⚠ CAUTION

- The power in this equipment will not be completely cut off from the wall outlet when the standby switch is turned off. Install the equipment so that the wall outlet is easily accessible and, in case of emergency, immediately unplug the power plug from the wall outlet. Mains plug is used as the disconnect device. It shall remain readily operable and should not be obstructed during intended use.

## Before Starting Playback

### Language Setting

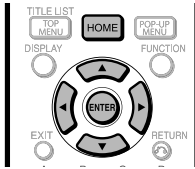

### Changing the on-screen display language

- 1 Press **HOME** to display the menu screen.
  - The same operation can be performed by pressing **ENTER** after selecting the HOME icon on the Wall Paper screen.
- 2 Press **▲/▼** to select "Settings", then press **▶** or **ENTER**.



- 3 Press **▲/▼** to select "On Screen Language", then press **▶** or **ENTER**.

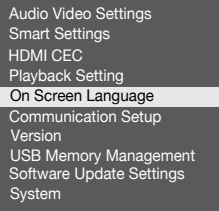

- 4 Press **▲/▼** to select the language you want to display on the screen, then press **ENTER**.

English	Nederlands	Česky
Deutsch	Svenska	Magyar
Français	Dansk	Slovensky
Italiano	Norsk	Slovenščina
Español	Suomi	
Português	Polski	

#### NOTE

- To select the DVD disc language, such as subtitle language, etc., see page 25.

### Operating a SHARP TV Using the Remote Control

The Universal Remote Control may operate the basic functions of the SHARP TV.

#### TV function control

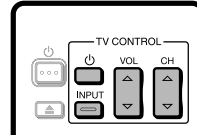

- TV Power:
- TV-AV Selector: INPUT
- TV Volume up/down: VOL  $\Delta/\nabla$
- TV Channel up/down: CH  $\Delta/\nabla$

### Turning Off the Indicator Lights

If you feel that the indicators on the player are too bright when watching movies, you can turn them off except for the (On/Standby) indicator.



Press **LIGHT** to turn the indicators on or off.

- Each time the button is pressed, the indicators are turned on or off.
- The on/off setting can also be performed using the menu screen (See page 38).

### Using HDMI CEC

#### Controlling the Blu-ray disc player using HDMI CEC

##### What you can do with HDMI CEC

When you connect this player to the LCD TV compatible with HDMI CEC using an HDMI cable, you can perform the functions listed below. (See page 17 for connecting to the HDMI terminal).

##### ● Automatic input select function

When you start playback of this player, the input selector of the LCD TV will automatically switch to the LCD TV input terminal connected to the player and the playback image will appear on the screen, even if you are watching a TV programme.

##### ● Automatic power off function

If you turn off the LCD TV when this player is in stop mode, the power of this player will be turned off automatically. (However, when playing back a disc or other content using this player, the power does not turn off.)

##### ● Automatic power on function

When you switch to the LCD TV input terminal connected to this player, the power of this player will be turned on automatically.

##### NOTE

- In order to make HDMI CEC available, connect an LCD TV to this player using an HDMI terminal. Set "HDMI CEC" to "Yes" (See page 38). Refer to the Operation Manual of the TV for details regarding setup.

### Using 3D

This sets output of 3D images.

To view 3D images, playback of 3D content (3D BD video) is necessary with a 3D compatible TV and 3D glasses in addition to this player.



Press **3D** to change to the 3D mode.

- Each time the button is pressed, the mode switches between "Auto(3D)" and "2D". The status of the selected mode will be displayed on the TV screen.

**Auto:** Video signals are output as 3D when 3D content (3D BD video) is played or as 2D when 2D content is played.

**2D:** Even if 3D content (3D BD video) is played, video signals are output as 2D at all times.

- This setting (Auto(3D)/2D) can also be performed using the menu screen (See page 39).

##### Regarding the 3D indicator

The 3D indicator lights green only when playing 3D content (3D BD video) with the setting "Auto(3D)" selected.

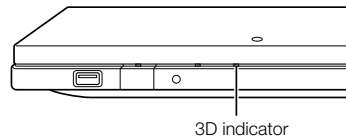

##### NOTE

- The 3D mode can be switched only when playback is stopped.
- Depending on the connected TV, the images during playback may switch to 2D images due to changes in the resolution, etc. Make sure the 3D image setting is performed on the TV.
- The 3D images may not be output as set in "HDMI Video Out".
- When performing Fast Forward/Reverse, images are shown in 2D.

##### CAUTION

- When viewing 3D images, viewing for a long period of time or lying on your back may cause eye strain and discomfort. In addition, 3D images may affect the eyesight of young children/infants, so keep them from viewing the images.



# Video/Picture/Music Playback

## Loading a Disc/Ejecting a Disc

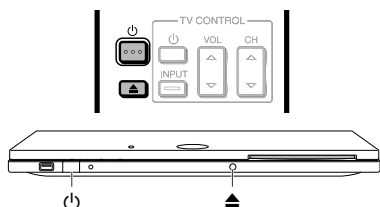

- 1 Press **⏻** to turn on the power.
- 2 Load a disc into the disc slot.
  - Insert the disc with the label face up.
  - In case of disc recorded on both sides, face down the side to play back.

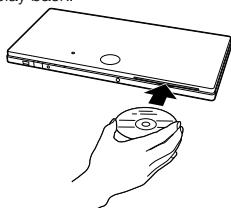

### To eject a disc

While in stop mode, press **⏮**.

## BD/DVD Video Playback

**BD VIDEO** | **BD-RE** | **BD-R**

**DVD VIDEO** | **DVD-R** | **DVD-RW**

This section explains playback of commercially available BD Video and DVD Video discs (like movies) and recorded DVD-RW/R discs.

- This player supports DVD upscaling during DVD playback.
- For a description of other playback functions, refer to "Playback Functions" on pages 31–33.



- 1 Load a disc.
  - Playback may begin automatically, depending on the disc.
  - Playback begins from the first title.
  - The menu may be displayed first, depending on the disc. Perform playback operation by following the directions on the screen.
  - When loading a disc containing 3D content (3D BD video) with "Yes" selected in the "3D Notice" setting (Page 39), playback will be stopped and the 3D notice will be displayed on the TV screen. In such cases, press **ENTER** for confirmation, and then playback will start.
- 2 Press **▶** (Play) if playback does not begin automatically or playback is stopped.

### NOTE

- The disc load time may vary depending on the disc.

### Regarding playback of BD video discs

- Some of the newly released BD video discs cannot be played back unless you update the player software to the latest version. Therefore, it may be required to update the software of the player. Refer to page 43 for more information regarding software updates for the player.

### To stop playback

Press **■**.

### Resume playback function

- If you press **▶** (Play) next, playback will resume from the point where the Player was previously stopped. To playback from the beginning, cancel resume mode by pressing **■**, then press **▶** (Play). (This may not work depending on the type of disc.)

### NOTE

- Resume playback may not function depending on the disc.

## Displaying the disc information



Press **DISPLAY** during playback.

- Each time you press **DISPLAY**, the display switches as follows.

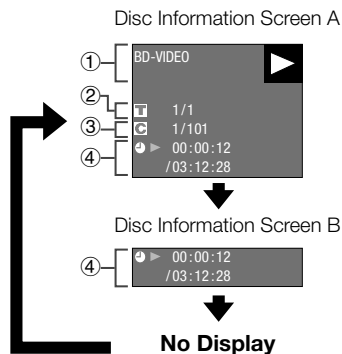

- 1 Type of disc
- 2 Title number being played / Total number of Titles
- 3 Chapter number being played / Total number of Chapters
- 4 Elapsed playback time / Total playback time for the Title

### NOTE

- Disc Information Screen A disappears after about 1 minute elapses without performing any operations.
- For some commercially-released BD VIDEO discs, the total playback time display for the Chapter/Title may not appear.

# Video/Picture/Music Playback

## BD/DVD Menus

- This section explains how to play back a BD/DVD video disc with a top menu, disc menu or pop-up menu.
- The titles listed in the top menu and a disc guide (for options like subtitles and audio languages) are given in the disc menu.

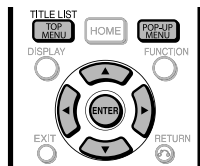

## Start playback by selecting a title from the top menu

BD VIDEO | DVD VIDEO

- 1 Press **TOP MENU/TITLE LIST**.
  - The top menu screen is displayed if present on the BD/DVD video disc.

### Example

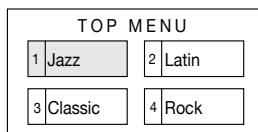

- 2 Press **▲/▼/◀/▶** to select the title, then press **ENTER**.
  - The selected title is played back.

### NOTE

- The procedure explained on this page is the basic operation procedure. Procedures vary depending on the BD/DVD video disc, so you may need to follow the instructions in the BD/DVD video disc manual or the instructions displayed on the screen.

### Top menu

- With some BD/DVD discs, the top menu may be referred to as the "Title Menu". Use **TOP MENU/TITLE LIST** on the remote control when the instructions refer to "Title Menu".
- If no top menu is available, the **TOP MENU/TITLE LIST** button will have no effect.

## Using the disc menu

DVD VIDEO

**Example:** Select "SUBTITLE LANGUAGE".

- 1 Press **TOP MENU/TITLE LIST**.
  - The disc menu screen is displayed if present on the DVD video disc.
- 2 Press **▲/▼** to select "SUBTITLE LANGUAGE", then press **ENTER**.
  - The screen for selecting the subtitle language is displayed.

### Example

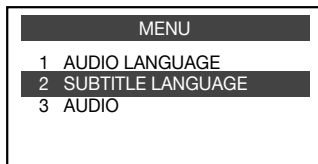

- 3 Press **▲/▼** to select the subtitle language, then press **ENTER**.
- 4 Press **TOP MENU/TITLE LIST** to exit.

## Using the pop-up menu

BD VIDEO

- 1 Press **POP-UP MENU** during playback.
  - The pop up menu screen is displayed.
  - The menu contents displayed vary depending on the disc. For details on how to see and operate the pop-up menu, refer to the manual for the disc.

### Example

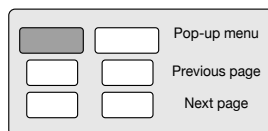

- 2 Press **▲/▼/◀/▶** to select the desired item, then press **ENTER**.
- 3 Press **POP-UP MENU** to exit.
  - The pop-up menu will automatically disappear for some discs.

## Video/Picture/Music Playback

### Enjoying BONUSVIEW or BD-LIVE

#### BD VIDEO

This Player is compatible with additional functions of BD-Video, BONUSVIEW (BD-ROM Profile 1 Version 1.1) and BD-LIVE.

For BD-Video discs compatible with BONUSVIEW, the functions of Picture in Picture and Virtual Package are available. For BD-LIVE compatible discs, you can enjoy a variety of functions via the Internet in addition to the BONUSVIEW functions.

Virtual Package/BD-LIVE data is saved in Local Storage (USB memory device connected to this Player). To enjoy these functions, connect a USB memory device (2GB or greater) supporting USB 2.0 High Speed (480Mbit/s) to the USB terminal on this player.

When you insert or remove a USB memory device, be sure to turn the main power off.

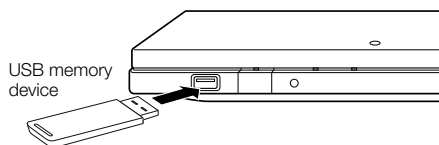

- If there is insufficient storage space, the data will not be copied/downloaded. Delete unneeded data or use a new USB memory device.
- If a USB memory device containing other data (previously recorded) is used, the video and audio may not play back properly.
- If the USB memory device is disconnected from this player during playback of Virtual Package/BD-LIVE data, playback of the disc will stop.
- Some time may be required for the data to load (read/write).
- Refer to "USB Memory Management" on page 42 for erasing the Virtual Package data and the BD-LIVE data in the USB memory device.

#### NOTE

- Kenwood cannot guarantee that all brands' USB memory devices will operate with this player.
- Only USB memory devices formatted with FAT 32/16 are compatible.  
When formatting a USB memory device using a PC, perform the following settings.  
Format File System: FAT32  
Allocation Unit Size: Default Allocation Size
- Do not use a USB extension cable when connecting a USB memory device to the USB terminal of the player.
  - Using a USB extension cable may prevent the player from performing correctly.

### Use of Picture in Picture function (secondary audio/video playback)

BD-Video that includes secondary audio and video compatible with Picture in Picture can be played back with secondary audio and video simultaneously as a small video in the corner.



- 1 Press **PinP** during playback to show the 2-picture screen.



Primary audio/video

Secondary audio/video

- 2 To remove the secondary video, press **PinP** again.

#### NOTE

- To listen to secondary audio, set the digital audio output setting (See "Audio Out" on page 37) according to the digital audio output format selection table on page 44.
- The secondary audio and video for Picture In Picture may automatically play back and be removed depending on the content. Also, playable areas may be restricted.

### Virtual Package

For BD-Video discs compatible with Virtual Package, data is copied from the discs or Internet to local storage. It is automatically copied to the local storage prior to playback. You can enjoy a variety of additional functions including secondary video, secondary audio, subtitles, movie trailers, etc.

- The playback methods vary depending on the disc. For details, refer to the disc manual.

### BD-LIVE

In this Player, a variety of contents with interactive functions are available through BD-LIVE compatible Blu-ray discs by connecting to the Internet. You can enjoy the download of bonus features such as latest movie trailers to the USB memory device, communication compatible BD-J interactive games, etc.

- The available functions differ depending on the disc.

#### NOTE

- Regarding playback method of BD-LIVE contents, etc., perform the operations in accordance with the instructions in the BD disc manual.
- To enjoy BD-LIVE functions, perform the broadband Internet connection (Page 19) and communication settings (Pages 40–41).
- Refer to page 39 regarding the setup to restrict access to BD-LIVE contents.
- If the BD-LIVE screen does not appear for a while after you select the BD-LIVE function in the BD disc menu, the USB memory device may not have enough free space. In such cases, eject the disc from the player, and then erase the data in the USB memory device in the "USB Memory Management" menu on page 42.

## DVD-R/-RW (VR format) / BD-RE/-R (BDAV format) Playback

DVD-R   DVD-RW   BD-RE   BD-R

You can play back a recorded disc (DVD: VR format finalised disc only / BD: BDAV format disc only).

- For a description of other playback functions, refer to "Playback Functions" on pages 31–33.

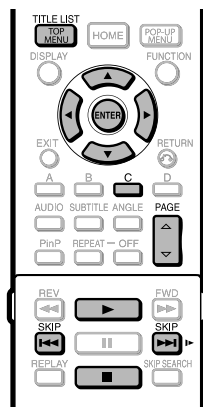

### NOTE

- "Finalise" refers to a recorder processing a recorded disc so that it will play in other DVD players/recorders as well as this player. Only finalised DVD discs will play back in this player. (This player does not have a function to finalise discs.)
- Some discs cannot be played back depending on the audio format.
- BD-RE/-R discs recorded from a BD recorder comply with AACS copyright protection technology. As this player is not intended to be compliant with AACS, such discs cannot be played back. (AACS: Advanced Access Content System)

## Playback by selecting a title

- Load a recorded disc.
  - Disc playback will begin automatically.
  - Playback begins from the first title.
- Press **■**.
- Press **TOP MENU/TITLE LIST**.
  - The Title List screen is displayed.

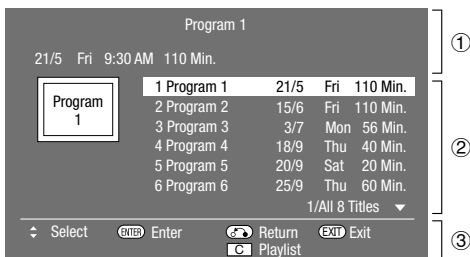

- Information of selected title
- Title Name  
Recording Date  
Recording Duration
- Button Guide

- When loading a BD disc with usage restrictions placed by a BD recorder, the password input screen appears. Then, input your password. If you input a wrong password three times, the disc will be ejected. Load the disc into the disc slot again, and then input a correct password.

- Press **▲/▼** to select the desired title, then press **ENTER** to start playback.
  - If you want to select additional titles, switch pages by pressing **PAGE ▲/▼**. The same operation can be performed by pressing **◀◀ SKIP** or **▶▶ SKIP/▶**.
  - You can playback by pressing **▶** instead of pressing **ENTER**.
- Press **■** to stop playback.

## Playback by selecting a Playlist

- Press **C (Yellow)** while the Title List screen is displayed.
  - The Playlist screen is displayed.
- Press **▲/▼** to select the desired title, then press **ENTER** to start playback.
- Press **■** to stop playback.

## Audio CD Playback

### AUDIO CD

This Player can play back audio CDs.

- For a description of other playback functions, refer to "Playback Functions" on pages 31–33.



### Playback from the beginning

- Load an audio CD.
  - The CD screen is displayed. (The CD screen is displayed only when a compact disc recorded in the CD-DA format is inserted.)
  - Playback may begin automatically, depending on the disc.

**Example:** when playing back Track 6

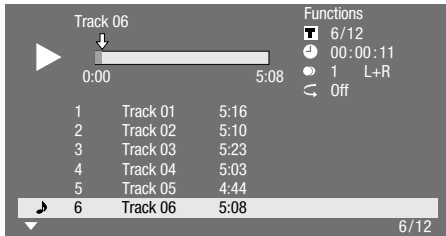

- Press **▶** (Play) if playback does not begin automatically or playback is stopped.
- To pause the playback at any time, press **⏸**.
  - Press **⏸** or **▶** (Play) to return to playback.
- Press **■** to stop playback.

#### NOTE

- Time display for each track will not be indicated on the screen until the track is played back.

### To skip the track during playback

Press **⏮** **SKIP** or **⏭** **SKIP/▶**.

- Press **⏮** **SKIP** to skip backward.
- Press **⏭** **SKIP/▶** to skip forward.

### Operation procedure for the "Functions" menu

- Press **D** (Blue) (Functions) when the CD screen is displayed.
  - The "Functions" menu is activated.

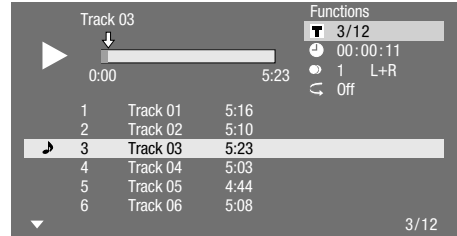

- Press **▲/▼** to select the desired setting, then press **ENTER**.
  - When playback is stopped, only "Track" can be selected.
  - For a description of each setting, see "Functions which can be set" (Page 35).
- Press **▲/▼/◀/▶** to set, then press **ENTER**.
  - Operations vary depending on the setting. Follow the operation instructions on the screen.
- Press **⏪** **RETURN** or **D** (Blue) to exit the "Functions" menu.

#### NOTE

- The displayed items vary depending on the disc.
- Audio channel and time skip functions are not available.

# Video/Picture/Music Playback

## Audio Data (MP3 File) Playback

CD-R CD-RW DVD-R DVD-RW USB

This Player can play back audio data (MP3 files) recorded on CD-R/RW discs, DVD-R/RW discs and USB memory devices.

- For details on the audio data that you can play using this player, refer to page 9.

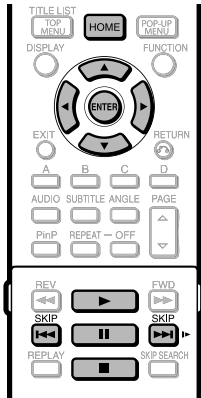

### Playing back Audio data (MP3 files)

When you insert or remove a USB memory device, be sure to turn the main power off.

- Load a disc or insert a USB memory device containing audio data (MP3 files), then press **HOME** to display the menu screen.
- Press **▲/▼** to select "Music", then press **▶** or **ENTER**.
- Press **▲/▼** to select "DVD/CD\*" or "USB Memory Device", then press **▶** or **ENTER**.
  - \* Display name varies depending on the type of media inserted.
  - If only a "DVD/CD" or a USB memory device is inserted, the "DVD/CD" or "USB Memory Device" selection screen does not appear. In such cases, after step 2, proceed to step 4.
- Press **▲/▼** to select a folder or file.
  - When you select a folder, press **ENTER** to open it, and then press **▲/▼** to select a file in the folder.

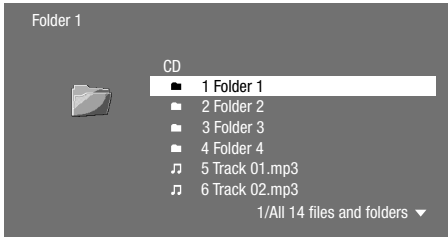

- Press **ENTER** to play back the selected file.
  - Playback of the selected file will begin.

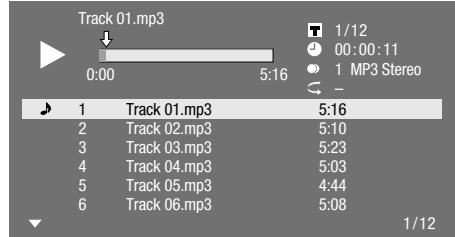

- When MP3 files are played, the "Functions" menu is not available.
- To pause the playback at any time, press **||**.
    - Press **||** or **▶** (Play) to return to playback.
  - Press **■** to stop playback.

### To play another file during Playback

Press **▲/▼** to select the file you want to play, then press **ENTER**.

- The chosen file will be played.

### To skip the file during Playback

Press **⏮ SKIP** or **SKIP ⏭**.

- Press **⏮ SKIP** to skip backward.
- Press **SKIP ⏭** to skip forward.

Playback

**NOTE**

- The Fast Forward/Reverse function does not work.
- The Repeat function does not work.
- When data in the USB memory device is played back, playback from the USB memory device will stop when **▲** on the remote control or the player is pressed or when a disc is inserted into the player.

(Continued on the next page)

## Video/Picture/Music Playback

### Displaying Still Images (JPEG files)

CD-R

CD-RW

DVD-R

DVD-RW

USB

This Player can display still images (JPEG files) recorded on CD-R/RW discs, DVD-R/RW discs and USB memory devices.

- For details on the still images that you can display using this player, refer to page 9.
- Still images are played one by one while during "Slide show", they are automatically replaced one after another.

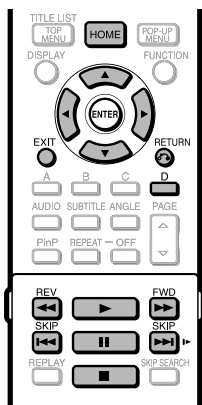

### Displaying Still Images (JPEG files)

When you insert or remove a USB memory device, be sure to turn the main power off.

- 1 Load a disc or insert a USB memory device containing Still Images (JPEG files), then press **HOME** to display the menu screen.
- 2 Press **▲/▼** to select "Picture", then press **▶** or **ENTER**.
- 3 Press **▲/▼** to select "DVD/CD\*" or "USB Memory Device", then press **▶** or **ENTER**.  
\* Display name varies depending on the type of media inserted.
  - If only a "DVD/CD" or a USB memory device is inserted, the "DVD/CD" or "USB Memory Device" selection screen does not appear. In such cases, after step 2, proceed to step 4.
- 4 Press **▲/▼** to select a folder or file.
  - When you select a folder, press **ENTER** to open it, and then press **▲/▼** to select a file in the folder.

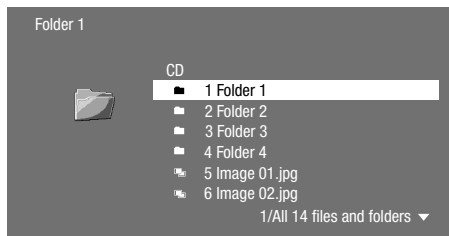

### NOTE

- Thumbnail data will be displayed when JPEG files from a digital camera contain thumbnail data.
- An icon will be displayed for JPEG files which do not contain thumbnail data.
- When data in the USB memory device is played back, playback from the USB memory device will stop when **▲** on the remote control or the player is pressed or when a disc is inserted into the player.

- 5 Press **ENTER** to display the selected file.
  - The selected still image appears on the screen.



- 6 Press **◀◀ SKIP** or **▶▶ SKIP/▶** to replace one image with another.
  - The same operation can be performed by pressing **◀◀ REV/▶▶ FWD**.
  - Press **↻ RETURN** if you wish to return to the selection screen.
- 7 To stop the still image display at any time, press **■**.

### Playing back Slide Show

- 1 To play back Slide Show, in Step 6 of the "Displaying Still Images (JPEG files)", press **▶ (Play) (Slide Show)**.
  - The still images inside the selected folder are played as a slide show.
- 2 To pause the playback at any time, press **II**.
  - Press **▶ (Play)** to return to playback of a slide show.
- 3 To stop the playback at any time, press **■**.

### Setting slide show speed/repeat playback

- 1 Press **D (Blue)** (Slide Show Menu) while the selection screen is displayed.
  - The setting screen for "Slide Show Speed"/"Repeat Mode Setting" appears.
- 2 Press **▲/▼** to select "Slide Show Speed", then press **▶** or **ENTER**.
- 3 Press **▲/▼** to select the desired speed, then press **ENTER**.
  - The slide show speed may be selected from "Fast", "Normal", "Slow1" and "Slow2".
- 4 Press **▲/▼** to select "Repeat Mode Setting", then press **▶** or **ENTER**.
- 5 Press **▲/▼** to select the desired item, then press **ENTER**.
  - The desired item may be selected from "Yes" or "No".
- 6 Press **EXIT** to exit.

# Playback Functions

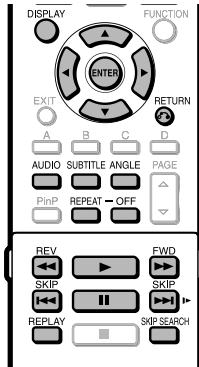

## NOTE

- Some operations in the following playback functions cannot be performed depending on the specifications of the disc.

## Fast Forward/Reverse (Search)

BD VIDEO | BD-R | BD-RE

DVD VIDEO | DVD-R | DVD-RW

AUDIO CD

The Fast Forward/Reverse function is enabled when **◀◀ REV** or **▶▶ FWD** is pressed during playback.

**Example:** When **▶▶ FWD** is pressed

- The search speed will change each time you press the button.

### When playing back a DVD

- You cannot perform Fast Forward/Fast Reverse from one title and continue to another title (except when playing audio CDs). At the end or beginning of the title, Fast Forward/Fast Reverse will be cancelled and normal playback will automatically resume.

## NOTE

- Subtitles are not played back with BD/DVD video discs during Fast Forward and Fast Reverse.

## Skipping to the Next or the Start of the Current Chapter (Track/Title)

BD VIDEO | BD-R | BD-RE

DVD VIDEO | DVD-R | DVD-RW

AUDIO CD | CD-R | CD-RW | USB

The Skipping (to the beginning of a chapter, track or title) function is enabled when **◀◀ SKIP** or **▶▶ SKIP/▶** is pressed during playback.

## Pause/Frame Advance Playback

BD VIDEO | BD-R | BD-RE

DVD VIDEO | DVD-R | DVD-RW

The Pause function is enabled when **||** is pressed during playback. (If you are playing back an audio CD, audio data [MP3 files] or still images [JPEG files], these will also pause.)

The Frame Advance Playback function is enabled when **▶▶ SKIP/▶** is pressed during pause.

- Frame Advance Playback may not function properly with discs other than DVD-RW/R (VR format).

## NOTE

- Some BD/DVD Video discs are not compatible with Pause/Frame Advance Playback.
- Frame Reverse Playback cannot be performed with this player.
- Frame Advance Playback does not work for BD-R/-RE.

## Slow Playback

BD VIDEO | BD-R | BD-RE

DVD VIDEO | DVD-R | DVD-RW

The Slow Playback function is enabled when **▶▶ SKIP/▶** or **▶** is pressed for more than 2 seconds during pause.

- Press **▶** (Play) to return to normal playback.

## NOTE

- This doesn't work for audio CDs.
- You cannot perform Slow Playback between titles. At the end of the title, Slow Playback will be cancelled and normal playback will automatically resume.
- Reverse Slow Playback cannot be performed with this player.

## Skip Search

BD VIDEO | BD-R | BD-RE

DVD VIDEO | DVD-R | DVD-RW

Playback skips 30 seconds ahead when **SKIP SEARCH** is pressed during playback.

## Replay

BD VIDEO | BD-R | BD-RE

DVD VIDEO | DVD-R | DVD-RW

Playback jumps back 10 seconds when **REPLAY** is pressed during playback.



## Repeat Playback of a Title or Chapter (Repeat Playback)

BD VIDEO | BD-R | BD-RE  
 DVD VIDEO | DVD-R | DVD-RW  
 AUDIO CD

- 1 Play back the title or chapter you want to repeat.
- 2 Press **REPEAT**.
- 3 Press **▲/▼** to select the type of Repeat Playback.
  - Playback Title: Repeats the title currently being played back.
  - Playback Chapter: Repeats the chapter currently being played back.
  - Scene Selection: Repeats the specified scene of title or chapter.

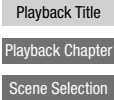

- Press **RETURN** to cancel without setting the type of Repeat Playback.
- For Audio CD, you can select "Playing Disc", "Playing Track" and "Specify The Part" as Repeat Playback options.

- 4 Press **ENTER**.  
**Example:** Repeat playback of a title (TITLE)

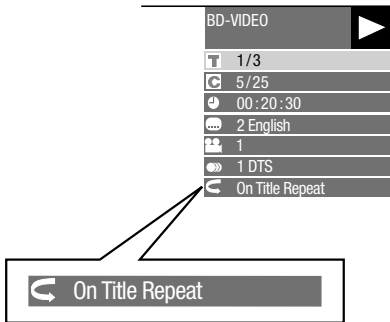

- 5 Press **REPEAT-OFF** or **REPEAT** to return to normal playback.

**NOTE**

- "Scene Selection" operation is not available for BD video.

## Partial Repeat Playback (Repeat Playback of a Specified Part)

DVD VIDEO | DVD-R | DVD-RW  
 AUDIO CD

- 1 Press **REPEAT** during playback.
- 2 Press **▲/▼** to select "Scene Selection", then press **ENTER**.
  - "Set Start Point" displays.

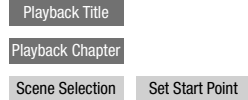

- 3 Press **ENTER** at the scene where you want to set the start point.
  - "Set End Point" displays.
- 4 Press **ENTER** at the scene where you want to set the end point.
  - You can press **FWD** to fast forward to the scene where you want to set the end point. When you reach the desired scene, simply press **▶** and then **ENTER** to set the end point. To cancel Repeat Playback, press **REPEAT-OFF** or **REPEAT**.

**NOTE**

- Press **SKIP/▶**, the Repeat Playback is cancelled and the next chapter being play back.
- Press **SKIP** once, the Repeat Playback is cancelled and the player returns to the start of current chapter (track).
- If you press **SKIP** again (within about 5 seconds) the player will skip to the beginning of the previous chapter (track).
- For Partial Repeat Playback, set the start and end points within the same title.
- Repeat Playback may be forbidden depending on the disc.
- Partial Repeat Playback may not work in multi-angle scenes.
- If you press **DISPLAY**, you can confirm the Repeat Playback status.

## Playback Functions

### Displaying the Audio Information

You can display the audio information on the disc currently being played back by pressing **AUDIO**.

- The displayed contents vary depending on the disc.

**BD VIDEO** **DVD VIDEO**

The audio channel currently being played back will be displayed.

If multiple audio channels are recorded, you can switch the audio channel by pressing **AUDIO**.

**DVD-RW** **DVD-R**

#### When a recorded broadcast with stereo or monaural audio is played back:

"Stereo" is displayed. (Audio cannot be switched.)

#### NOTE

- When you play a programme recorded in stereo or monaural, and if you are listening to the Bitstream sound via the digital output jack, you cannot select the audio channel. Set the digital audio output setting to "PCM" (Page 37).
- Settings for audio can also be changed in the Function Control screen (Page 34).
- The operation of audio differs according to each disc. You may need to refer to the operation manual of the disc.
- The display for audio information automatically disappears after 5 seconds.

### Switching Subtitles

**BD VIDEO** **DVD VIDEO**

If subtitles are provided in multiple languages, you can switch between them.

Press **SUBTITLE** during playback.

- The display indicates the subtitle number currently being played back, and the subtitles appear. Each time **SUBTITLE** is pressed, the subtitles change.
- "—" is displayed if a disc has no subtitles.
- You can also select "Off".

#### NOTE

- Settings for subtitles can also be changed in the Function Control screen (Page 34).
- The operation of subtitles differs according to each disc. You may need to refer to the operation manual of the disc.
- The display for subtitle information automatically disappears after 5 seconds.

### Switching the Angle

**BD VIDEO** **DVD VIDEO**

If multiple angles are recorded, you can switch between them.

Press **ANGLE** during playback.

- The display indicates the angle number currently being played back. Each time you press **ANGLE**, the angle switches.

To return to the previous angle, press **ANGLE** to cycle through the angles until you return to the original angle.

#### NOTE

- The displayed items vary depending on the disc.
- If you access the Function Control screen during playback of a BD/DVD video, it may be impossible to operate the BD/DVD video playback. In cases like this, close the Function Control screen.
- The operation of angles differs according to each disc. You may need to refer to the operation manual of the disc.
- The display for angle information automatically disappears after 5 seconds.

### Displaying the Angle Mark

**BD VIDEO** **DVD VIDEO**

You can change settings so that Angle Mark appears in the right bottom part of the screen when multiple angles are recorded. The settings can be changed in "Settings" – "Playback Setting" – "Angle Mark Display" (Page 38).

# Settings During Playback

## Function Control

BD VIDEO | BD-R | BD-RE  
DVD VIDEO | DVD-R | DVD-RW  
AUDIO CD

This allows you to adjust various settings at once, like subtitles, angle settings and the title selection for Direct Playback. You can adjust the video and audio to suit your preferences. The operations are the same for BD and DVD.

### Function Control screen

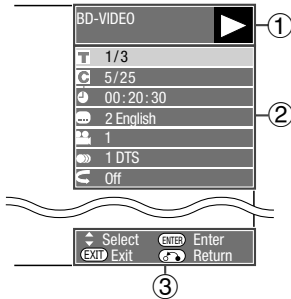

#### ① Playback status display

Shows the operation status and the disc type.

#### ② Setting items

Selects a title (or track) or chapter for playback, or performs video/audio settings.

- Title/Track Number (Direct Title/Track Skip)
- Chapter Number (Direct Chapter Skip)
- Playback Elapsed Time (Direct Time Skip)
- Subtitle Language
- Angle Number
- Audio
- Repeat

#### ③ Operation guide display

Provides help on remote control button operations.

## Function control operation procedure

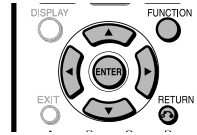

- 1 Press **FUNCTION** during playback.
  - The Function Control screen is displayed on the TV.
- 2 Press **▲/▼** to select the desired setting, then press **ENTER**.
  - For a description of each setting, see "Functions which can be set" (Page 35).

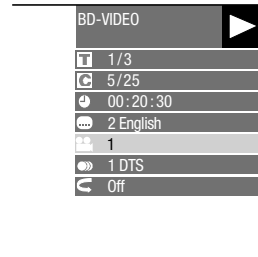

- 3 Press **▲/▼/◀/▶** to set, then press **ENTER**.
  - Operations vary depending on the setting. Follow the operation instructions on the screen.
- 4 Press **RETURN** or **FUNCTION** to close the Function Control screen.

#### NOTE

- If "--" is displayed for an option like title number or subtitles, the disc has no titles or subtitles which can be selected.
- The displayed items vary depending on the disc.
- If you access the Function Control screen during playback of a BD/DVD video, it may be impossible to operate the BD/DVD video playback. In cases like this, close the Function Control screen.

## Settings During Playback

### Functions which can be set

#### **T** Title/Track Number (Direct Title/Track Skip)

- Shows the title number being played back (or track number when playing back an audio CD). You can skip to the start of the title (or track).
- To skip to the start of a selected title (or track), press the **Number** buttons to enter the title (or track) number when this option is highlighted.

#### **C** Chapter Number (Direct Chapter Skip)

- Shows the chapter number being played back. You can skip to the start of the chapter.
- To skip to the start of a selected chapter, press the **Number** buttons to enter the chapter number when this option is highlighted.

#### **D** Playback Elapsed Time (Direct Time Skip)

- Shows the time elapsed from the beginning of the current disc title (or track). This lets you skip to a specific time.
- Press **◀/▶** to select the Hour, Minute or Second, then press **▲/▼** or the **Number** buttons to set the time. Press **ENTER** to start playback at the set time.

#### **NOTE**

- **ENTER** button under the Cover: Enters the input number.
- **CLEAR** button under the Cover: Clears the input number.

#### **...** Subtitle Language

- Shows the currently selected subtitle language. If subtitles are provided in other languages, you can switch to your preferred language.

#### **👤** Angle Number

- Shows the currently selected angle number. If the video is recorded with multiple angles, you can switch the angle.

#### **🔊** Audio

- Shows the currently selected type of audio. You can select the desired type of audio.

#### **↺** Repeat

- The current Title (or Chapter) or partial segments can be repeatedly played back. Repeat Playback is also possible with the **REPEAT** button on the remote control.

#### **NOTE**

- These functions may not work with all discs.

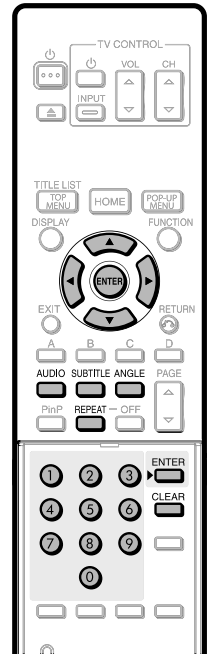

# SETTINGS

## Common operations

The “menu” enables various audio/visual settings and adjustments on the functions using the remote control unit. You need to call up the On Screen Display to perform settings for this player. The following is the explanation for the basic operations of the “menu”.

**Example:** Setting “HDMI CEC”

**1 Display the menu screen**

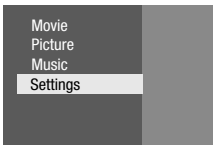

Press **HOME** to display the menu screen.

- The same operation can be performed by pressing **ENTER** after selecting the HOME icon on the Wall Paper screen.

Press **▲/▼** to select “Settings”, then press **▶** or **ENTER**.

**2 Select a menu item**

Press **▲/▼** to select “HDMI CEC”, then press **▶** or **ENTER**.

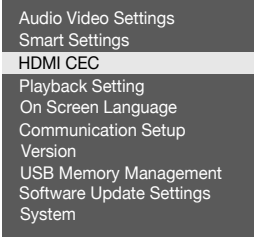

**3 Select the next item**

Press **▲/▼** to select the desired item, then press **ENTER**.

Press **↶** **RETURN** to return to the previous “menu” page.

**4 Exit the menu screen**

Press **HOME** or **EXIT** to exit.

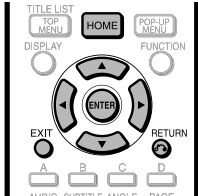

## Basic Operation for Playback Setting

**Example:** Setting “Parental Control” under “Playback Setting”

- Press **HOME** to display the menu screen.
  - The same operation can be performed by pressing **ENTER** after selecting the HOME icon on the Wall Paper screen.
- Press **▲/▼** to select “Settings”, then press **▶** or **ENTER**.
- Press **▲/▼** to select “Playback Setting”, then press **▶** or **ENTER**.
- Press **▲/▼** to select “Parental Control”, then press **▶** or **ENTER**.
  - When you operate this Player for the first time, the PIN code setting screen will be displayed. See “When setting the PIN code for the first time” below.

- Enter your 4-digit PIN code.
  - You cannot move to the next setting screen until you can input the correct PIN code.
- Enter a 4-digit number for the PIN code, then the same 4-digit number for confirmation.
- Press **ENTER** to complete the PIN code setting procedure and move to the next setting screen.
- Press **◀/▶** to select the parental control level for DVD VIDEO/BD-ROM, and then select the country code. Press **ENTER** after making each selection.

**Example:** when the selected parental control level is “8”

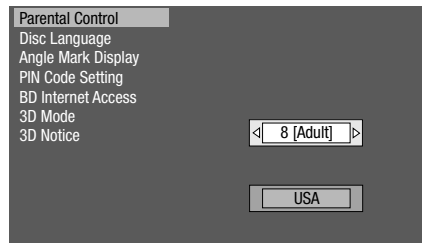

### When setting the PIN code for the first time.

- To set the PIN code for the first time, press **▲/▼** to select “Yes” to enter the PIN code setting menu, then press **▶** or **ENTER**.

- Press **HOME** or **EXIT** to exit.

# SETTINGS

## Audio Video Settings

### TV Aspect Ratio

You can set the screen aspect ratio of the connected TV, and adjust the video output.

If you switch your TV (i.e. because you have bought a new one) and the screen aspect ratio of the connected TV changes, you will have to change the "TV Aspect Ratio" setting.

#### Item

Wide 16:9: Select this when connecting to a TV with a 16:9 screen aspect ratio.

Normal 4:3: Select this when connecting to a TV with a 4:3 screen aspect ratio.

### <When selecting Normal 4:3>

#### Item

Letter Box: If you connect to a TV with a screen aspect ratio of 4:3 and playback a disc with 16:9 video, the video will be played back with black bands at the top and bottom while maintaining the 16:9 ratio.

Pan Scan: If you connect to a TV with a screen aspect ratio of 4:3 and playback a disc with 16:9 video, the video will be played back with the left and right sides of the image cut off to display in 4:3 screen aspect ratio. (This function works if the disc is labelled for 4:3PS.)

### HDMI Video Out

This sets the resolution of the HDMI video output. Some TVs are not fully compatible with the Blu-ray disc player, which may cause the image distortion. In this case, press **VIDEO OUTPUT RESET** on the remote control for five seconds. "HDMI Video Out" will be reset to "Auto" (factory preset value).

#### Item

Auto, 1080p, 1080i, 720p, 576/480p

#### NOTE

- When the BD player is connected to a 1080p 24Hz compatible TV and the "HDMI Video Out" is set to "Auto", 1080p 24Hz will automatically be displayed when compatible discs are played back.

### Audio Out

This lets you set the digital audio output format according to the capabilities of the connected audio equipment.

- To listen to the secondary audio of Blu-ray discs, select "PCM" or "Bitstream (Mix)".
- For details, refer to the digital audio output format selection table on page 44.

#### Item

PCM, Bitstream (Mix), Bitstream

#### NOTE

- Make sure to select a compatible digital audio output format, otherwise you will hear no sound or a garbled noise.
- If the HDMI device (Receiver, TV) is not compatible with compressed formats (Dolby digital, DTS), the audio signal outputs as PCM.
- Secondary and Effect audio is not present on DVD video.
- This setting has no effect on the analogue (L/R) audio or HDMI audio output to your TV. It is only valid for the optical and HDMI audio output to a receiver.
- If you play MPEG audio soundtracks, the audio signal format will be PCM regardless of digital audio output format selection (PCM or Bitstream).

### Dynamic Range Control

This lets you adjust the range between the loudest and softest sounds (dynamic range) for playback at average volume. Use this when it is hard to hear dialogue.

#### Item

Normal: The same audio output range is played as the original recorded audio output range.

Shift\*: When Dolby Digital audio is played back, the dynamic range of the audio is adjusted so that the dialogue portion can be heard easily. (If the audio sounds abnormal, set to "Normal".)

Auto: When you play back audio in the Dolby TrueHD format, the dynamic range is automatically adjusted.

- \* Lower the audio volume before setting. If you do not do so, the speakers may emit a loud sound or excessive output may be applied to the speakers.

## SETTINGS

### Smart Settings

#### Auto Power Off

This sets the Player so that power is automatically shut off if playback is stopped and you do not perform any operations for about 10 minutes.

**Item**

Yes, No

#### Front LED

If you feel that the indicators on the player are too bright when watching movies, you can turn them off except for the  (On/Standby) indicator.

**Item**

On, Off

#### Screen Saver

This function helps prevent burn-in on the TV screen by leaving the player with the power turned on for a long period of time. This lets you set the length of time before it activates.

**Item**

Off, 5min, 10min, 20min, 30min

### HDMI CEC

You can select the usage for the HDMI CEC function.

**Item**

Yes, No

 **NOTE**

- For details, refer to the operation manual of TV.

### Playback Setting

#### Parental Control

This lets you set the Parental Control for BD-ROM/DVD-video depending on the disc content.

The 4-digit PIN code number needs to be entered before the Parental Control Levels and the Country Code are set. The Parental Control Levels and the Country Code cannot be set if a PIN code has not been created or the PIN code is not entered.

- Select the rating level appropriate for the age of the user.

**Item (Parental control level)**

8 and Off: All BD-video/DVD-video can be played.

1-7: Prohibits play of BD-video/DVD-video with corresponding ratings recorded on them.

**Item (Country code)**

Select the country code.

- The ratings differ according to the country.

 **NOTE**

- Refer to "Basic Operation for Playback Setting" on page 36 for details.

#### Disc Language (Disc Priority Language)

This lets you select the language for subtitles, audio and menus displayed on the screen.

**Item (Subtitle)**

Select the subtitle language you want to display.

**Item (Audio)**

Select the audio language you want to hear.

**Item (Menu)**

Select the menu language you want to display.

 **NOTE**

- When "Auto" is selected, the priority language of the disc will be played back.

#### Angle Mark Display

This lets you turn the Angle Mark Display on or off when BD/DVD video recorded with multiple angles is played back. (The Angle Mark is displayed in the lower right screen.)

**Item**

Yes, No

## SETTINGS

### PIN Code Setting

This sets the PIN code for setting or changing the Parental Control Level.

#### Item

Yes: Enter the 4-digit number.  
No

#### NOTE

- When you forget the PIN code, you can reset the current PIN code using "System Reset" under "Settings". (See this page.)
- You can also set the new PIN code if desired.

### BD Internet Access

This allows you to set access restriction to BD-LIVE contents.

#### Item

Permit: Allows all BD-LIVE discs.  
Limit: Allows only discs with owner certification.  
Prohibit: Prohibits all BD-LIVE discs.

#### NOTE

- The available functions differ depending on the disc.
- Regarding playback method of BD-LIVE contents, etc., perform the operations in accordance with the instructions in the BD disc manual.
- To enjoy BD-LIVE functions, perform the broadband Internet connection (Page 19) and communication settings (Pages 40–41).

### 3D Mode

This sets output of 3D images.

To view 3D images, playback of 3D content (3D BD video) is necessary with a 3D compatible TV and 3D glasses in addition to this player.

#### Item

Auto: Video signals are output as 3D when 3D content (3D BD video) is played or as 2D when 2D content is played.  
2D: Even if 3D content (3D BD video) is played, video signals are output as 2D at all times.

#### CAUTION

- When viewing 3D images, viewing for a long period of time or lying on your back may cause eye strain and discomfort. In addition, 3D images may affect the eyesight of young children/infants, so keep them from viewing the images.

### 3D Notice

This sets whether or not a notice is displayed ("Yes" or "No") on the connected TV every time 3D content (3D BD video) is played.

#### Item

Yes, No

### On Screen Language

You can set the language you want to display on the screen.

#### Item

English, Deutsch, Français, Italiano, Español, Português, Nederlands, Svenska, Dansk, Norsk, Suomi, Polski, Český, Magyar, Slovensky, Slovenščina

### Version

When you select "Version", the system software version is displayed.

### System

#### System Reset

You can reset all settings to the factory presets.

#### Item

Reset, Not Reset

#### DivX Register

The DivX registration code is displayed.

#### Item

Yes, No

#### NOTE

- To learn more, visit [www.divx.com/vod](http://www.divx.com/vod).

#### DivX Deactivate

You can deactivate your DivX information on the player.

#### Item

Yes, No

#### NOTE

- To learn more, visit [www.divx.com/vod](http://www.divx.com/vod).



# SETTINGS

## Communication Setup

This allows you to perform and/or change the communication settings. This setting is required to use BD-LIVE functions.

### NOTE

- For manually performing the setting, the following information of the connected router or modem is required. Confirm the information prior to the setting.
  - IP address, netmask, gateway, DNS address

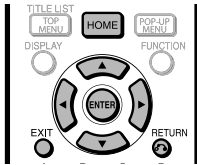

## When using a LAN Cable

### NOTE

- Make sure that the LAN cable is connected to this player if a wired Internet connection is made (See page 19). This setting cannot be performed when a LAN cable is not connected.

- Press **HOME** to display the menu screen.
- Press **▲/▼** to select "Settings", then press **▶** or **ENTER**.
- Press **▲/▼** to select "Communication Setup", then press **▶** or **ENTER**.
- Press **▲/▼** to select "Ethernet Setup (Cable)", then press **▶** or **ENTER**.
- Press **▲/▼** to select "Change", then press **ENTER**.

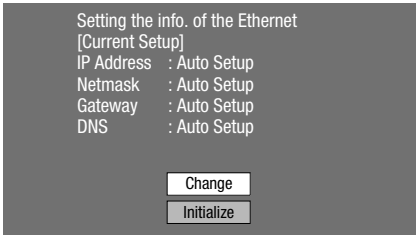

- For initializing the current setting, select "Initialize", then press **ENTER**.

- For setting the IP address, press **◀/▶** to select "Yes" or "No", then press **ENTER**.

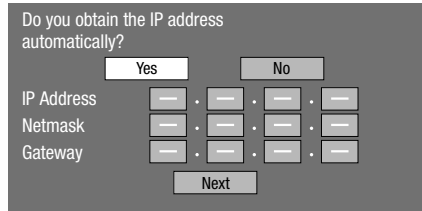

- If selecting "Yes": The IP address is automatically obtained.
- If selecting "No": The IP address, netmask and gateway are manually entered using the screen for inputting characters. (See page 41.)  
Regarding each of the setup values, confirm the specifications of your broadband router.

- Select "Next", then press **ENTER**.
- If selecting "Yes" in the step 6, go to the step 9.
- Enter your DNS address.



- The primary and secondary DNS addresses are entered using the screen for inputting characters. (See page 41.)  
Regarding each of the setup values, confirm the specifications of your broadband router.

- Select "Next", then press **ENTER**.
- For testing the connection to the Internet, after confirming the settings, press **▲/▼** to select "Test", then press **ENTER**.
  - "Test" is available only when setting to obtain the IP address automatically. "Test" cannot be selected if the IP address has not been obtained automatically.

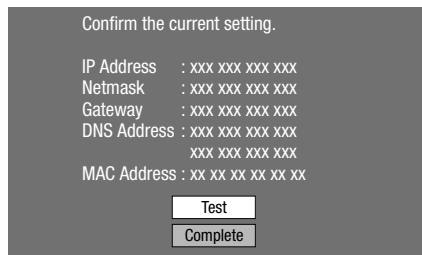

- As a result of the test, if the Internet connection fails, enter the setup values manually.

- Press **▲/▼** to select "Complete", then press **ENTER**.

# SETTINGS

## The operation procedure for inputting characters manually

### NOTE

- Numeric characters such as IP address can be entered on the input screen either by selecting each of the characters in the "Numeric" mode or using the **Number** buttons on the remote control.

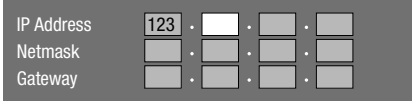

- Press **ENTER** at the boxes in which characters are to be entered, and the input screen will appear.

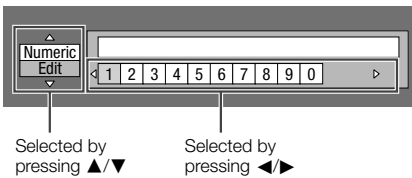

- Press ▲/▼ to select the desired input mode.
- Press ◀/▶ to select a number/character, then press **ENTER**.

- Repeat the step 3 to display all of the desired characters/numbers in the input field.

**Example:** The screen for inputting numeric characters

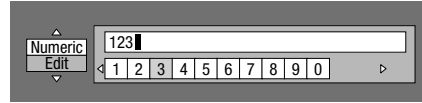

### NOTE

- Press **RETURN** (Del.Char.) to delete a number/character you have input. Input numbers/characters can also be deleted by pressing **A** (Red).
- To change a number/character you have input, press **B** (Green) (Left) or **C** (Yellow) (Right) to select the number/character you want to change, and press **RETURN** (Del.Char.). Then, press ◀/▶ to select a new number/character you want to input, and press **ENTER**.

- Press **D** (Blue) (Complete) to fix the numbers which have been input.

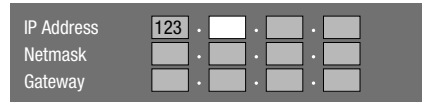

- Repeat step 1 to 5 to finish inputting all the required characters.

## Input character list

1ABC (Alphabet/ numeric character)	Num. ABC DEF GHI JKL MNO PQRS TUV WXYZ Spc.
	Num. 1 2 3 4 5 6 7 8 9 0 ABC ABC abc DEF DEF def
	GHI G H I g h i JKL J K L j k l MNO M N O m n o
	PQRS P Q R S p q r s TUV T U V t u v WXYZ W X Y Z w x y z
Sp. (space)	
Numeric	1 2 3 4 5 6 7 8 9 0
Sign	@ . , ; _ - \ \$ % ! ? & # + * = /   ~ " ' ^ ` ( ) < > [ ] { } Spc.
	@ . , : @ . , : ; _ - \ ; _ - \ \$ % ! ? \$ % ! ?
	& # + * & # + * = /   ~ = /   ~ " ' ^ ` " ' ^ `
	( ) < > ( ) < > [ ] { } [ ] { } Spc. (space)
Edit	Cancel Left Right Complete Del.Char.

\* The same operation as the coloured buttons and **RETURN** can be performed by selecting each of the items and pressing **ENTER**.  
"Del.Char." stands for deleting characters.

(Continued on the next page)

## SETTINGS

### Before using the USB memory device

#### CAUTION:

- Do not remove the USB memory device or unplug the AC cord while the operations for "USB Memory Management" or "Software Update (Manual Update from USB memory device)" are being performed.
- Do not use a USB extension cable when connecting a USB memory device to the USB terminal on the player.
  - Using a USB extension cable may prevent the player from performing correctly.

#### NOTE:

- Kenwood cannot guarantee that all brands' USB memory devices will operate with this player.
- Only USB memory devices formatted with FAT 32/16 are compatible.  
When formatting a USB memory device using a PC, perform the following settings.  
Format File System: FAT32  
Allocation Unit Size: Default Allocation Size

### USB Memory Management

The following instructions explain how to delete data such as the Virtual Package data and the BD-LIVE data in a USB memory device.

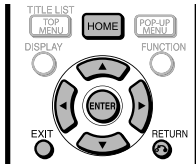

When you insert or remove a USB memory device, be sure to turn the main power off.

- 1 Insert the USB memory device into the USB terminal on this player.

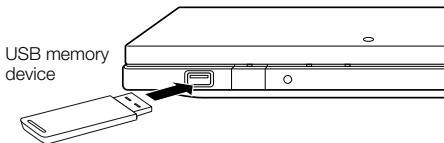

- 2 Press **HOME** to display the menu screen.
- 3 Press **▲/▼** to select "Settings", then press **▶** or **ENTER**.

- 4 Press **▲/▼** to select "USB Memory Management", then press **▶** or **ENTER**.

- The "USB Memory Management" screen is displayed.
- "No USB Memory" appears when no USB memory is inserted.

- 5 Press **▶** or **ENTER** to proceed.

Erase: Deletes only BD-VIDEO data written on the USB memory device such as BD-LIVE data.

- If you want to delete all of the data or delete only the unneeded software update data after the software is updated, delete the data on the USB memory device using a PC.

- 6 Press **▲/▼** to select "Yes", then press **ENTER**.

- 7 Start the process.

- The screen for the current operation will display.

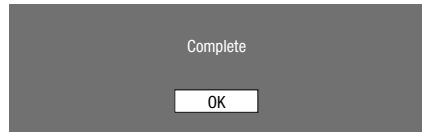

- 8 Press **ENTER**.

#### NOTE

- Data which has been saved to the player's internal memory (game score, etc.) will also be deleted.

## Software Update Settings

### Manual Update from USB memory device

This function allows software updates by inserting a USB memory device with the update file into the USB terminal on this player.

- When a software update is performed, the software update data must be written onto the USB memory device in advance using a PC.
- The USB memory device must be clear of all files except software update data to allow new software uploading.
- When software update data is released, copy the data onto a USB memory device after downloading it to a PC.
- For methods such as downloading and copying to a USB memory device, carefully read the description shown on the website before performing the operation.

**NOTE**

- Only USB memory devices formatted with FAT 32/16 are compatible.  
When formatting a USB memory device using a PC, perform the following settings.  
Format File System: FAT32  
Allocation Unit Size: Default Allocation Size
- Do not extract the firmware update file to any folders other than the root directory on the USB memory device. The firmware update file must be only one file directly in the root directory.

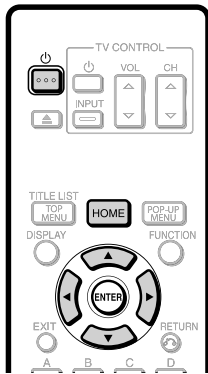

**CAUTION**

- Do not remove the USB memory device or unplug the AC cord while the software is being updated.

When you insert a USB memory device, be sure to turn the main power off.

- 1 Insert the USB memory device with the update file into the USB terminal on this player.

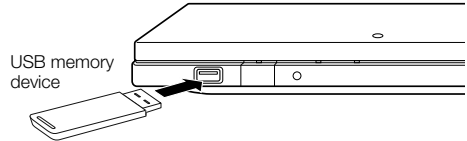

- 2 Press **POWER** to turn on the power.
  - The screen shown in part ② of step 9 will be automatically displayed. (Go to part ② of step 9.)
  - If "No" is selected in part ② of step 9 and wish to update the software manually, perform the operations from step 3.
- 3 Press **HOME** to display the menu screen.
- 4 Press **UP/DOWN** to select "Settings", then press **RIGHT** or **ENTER**.
- 5 Press **UP/DOWN** to select "Software Update Settings", then press **RIGHT** or **ENTER**.
- 6 Press **RIGHT** or **ENTER** to move to the menu to the right.
- 7 Press **UP/DOWN** to select "USB Memory", then press **ENTER**.
- 8 Press **ENTER** to start checking data in the USB memory device.

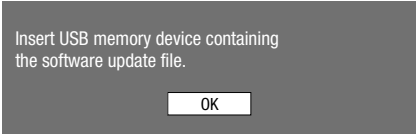

- 9 ① During the data checking, "Checking" blinks.

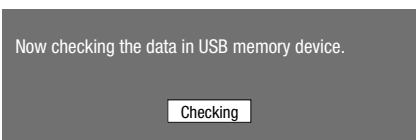

## SETTINGS

- ② The current version of this unit software and the version of the update file on the USB memory device are displayed. To update this player software with update file, select “Yes”, and press **ENTER**.

Software update file is detected in the USB memory device. Start update?

Current Ver. :            xxxxxxxxxx  
Update Ver. :            yyyyyyyyyy

- ③ If the USB memory device is not properly installed or the correct update file cannot be found on the USB memory device, an error message is displayed. Check the file on the USB memory device, and then reinsert the USB memory device correctly.

Software update file is not detected in the USB memory device. Confirm that you have transferred the file to the USB memory device and retry software update. Confirm that you have inserted the USB memory device into the correct device.

There is more than one software file in the USB memory device. Confirm that only the software update file is in the USB memory device.

- 10 Press **ENTER** to start updating.

- The screen becomes dark for a while until the update screen can be displayed. Please wait for the update screen to appear. Do not unplug the AC cord.

The picture will temporarily go dark until the software update display appears. Wait several minutes and do not unplug the AC cord.



Now updating

- Do not unplug AC cord.

Update Version        yyyyyyyyyy

30%

- 11 When the software is successfully updated, a screen is displayed indicating that the update process is completed.

- If the update has failed, check the file in the USB device and try Software Update again.

- 12 Remove the USB memory device.

- 13 Press **⏻** to turn off the player.

- Delete unneeded software update data using a PC after the software update process is completed.

## Digital Audio Output Selection Formats

Setup	Definition	Output terminal	Audio Stream							
			PCM	Dolby Digital	Dolby Digital Plus	Dolby TrueHD	DTS	DTS-HD HR	DTS-HD MA	
PCM	Decodes Primary, Secondary and Effect audio streams together into PCM audio.	HDMI OUT	PCM	PCM	PCM	PCM	PCM	PCM	PCM 7.1ch	PCM 7.1ch
		OPTICAL	PCM 2ch	PCM 2ch	PCM 2ch	PCM 2ch	PCM	PCM	PCM 2ch	PCM 2ch
Bitstream (Mix)	Decodes Primary, Secondary and Effect audio streams together into PCM audio, then re-encodes the PCM audio into DTS bitstream.	HDMI OUT/ OPTICAL	DTS	DTS	DTS	DTS	DTS	DTS	DTS 5.1ch	DTS 5.1ch
Bitstream	Outputs only the Primary audio soundtrack (main soundtrack of the movie) so that your audio equipment can decode the audio bitstream. You will not hear Secondary and Effect audio.	HDMI OUT	PCM	Dolby Digital	Dolby Digital Plus	Dolby TrueHD	DTS	DTS	DTS-HD HR	DTS-HD MA
		OPTICAL	PCM 2ch	Dolby Digital	Dolby Digital	Dolby Digital	DTS	DTS	DTS-ES 5.1ch	DTS-ES 5.1ch

Blu-ray discs may include three audio streams.

- Primary Audio: The audio soundtrack of the main feature
- Secondary Audio: Additional soundtrack such as director or actor's commentary.
- Interactive Audio: Interactive sounds will be heard when selected.  
Interactive Audio is different on each Blu-ray Disc.

### NOTE

- Digital audio cannot be copied from the OPTICAL DIGITAL OUT terminal.

# Troubleshooting

The following problems do not always suggest a defect or malfunction of this Player. Refer to the problems and lists of possible solutions below before calling for service.

## Power

Problem	Possible causes and solutions
The Player power cannot be turned on.	<ul style="list-style-type: none"> <li>• Make sure that the AC adapter cord is connected to the DC IN terminal on the rear of the player, the AC cord is connected to the AC adapter and the AC cord is plugged into an AC outlet. (Page 21)</li> <li>• Reset the player. (Page 47)</li> </ul>
The Player power is turned off.	<ul style="list-style-type: none"> <li>• Is "Auto Power Off" set to "Yes"? When "Auto Power Off" is set to "Yes", the power will be automatically turned off after 10 continuous minutes of inactivity (no playback). (Page 38)</li> </ul>

## Basic Operation

Problem	Possible causes and solutions
The remote control does not work.	<ul style="list-style-type: none"> <li>• Use the remote control within its operating range. (Page 20)</li> <li>• Replace the batteries. (Page 20)</li> <li>• Reset the remote control.             <ul style="list-style-type: none"> <li>– Press and hold <b>1</b> (the number button) first and then <b>⏻</b> on the remote control together for more than 5 seconds.</li> </ul> </li> </ul>
Cannot operate the Player.	<ul style="list-style-type: none"> <li>• Are you operating the Player within the specified operating temperature range? (Page 49)</li> </ul>

## Playback

Problem	Possible causes and solutions
The Player cannot play a disc.	<ul style="list-style-type: none"> <li>• Take out the disc and clean it. (Page 12)</li> <li>• Make sure that the disc is loaded properly (label-side up). (Page 24)</li> <li>• Make sure that region code on the disc matches that of this Player. (Page 8)</li> <li>• Allow any condensation in or near the Player to dry. (Page 12)</li> <li>• Check that the disc is recorded in the compatible TV system (PAL or NTSC).</li> <li>• The Player cannot play back video which was not recorded normally. (Page 8)</li> <li>• Proper playback may be impossible due to the state of the disc recording, a scratched, warped or dirty disc, the state of the pick-up, or compatibility issues between this Player and the disc being used. (Pages 8, 12)</li> <li>• When the recorded time of a disc is unusually short, playback may not be possible.</li> <li>• BD-RE/R discs recorded in a format other than BDMV/BD-RE cannot be played back. (Page 8)</li> </ul>
The disc is automatically ejected after loading a disc.	<ul style="list-style-type: none"> <li>• Make sure that the disc is loaded properly (label-side up). (Page 24)</li> <li>• Take out the disc and clean it. (Page 12)</li> <li>• Make sure that the disc is playable. (Page 8)</li> </ul>
Video stops.	<ul style="list-style-type: none"> <li>• Has the Player been subjected to shock or impact? Are you using it in an unstable location? The Player will stop if it senses shock or vibration.</li> </ul>
The Player makes a snapping sound when starting playback or loading a disc.	<ul style="list-style-type: none"> <li>• The player may sometimes make a snapping sound when starting playback if it has not been operated in a while. These sounds are not malfunctions of the player but are normal operating conditions.</li> </ul>

## Troubleshooting

### Picture

Problem	Possible causes and solutions
No picture.	<ul style="list-style-type: none"> <li>• Make sure that the cables are connected correctly. (Page 17)</li> <li>• Make sure that the connected TV or the AV receiver is set to the correct input. (Page 17)</li> <li>• Take out the disc and clean it. (Page 12)</li> <li>• Make sure that region code on the disc matches that of this Player. (Page 8)</li> <li>• There is no picture from the HDMI output.               <ul style="list-style-type: none"> <li>– Are the settings performed correctly? Please check the settings. (Page 37)</li> </ul> </li> </ul>
Screen freezes and operation buttons do not work.	<ul style="list-style-type: none"> <li>• Turn off the power and turn on the power again.</li> <li>• If the power is not turned off, perform a reset. (Page 47)</li> <li>• Is the disc damaged or dirty? Check the condition of the disc. (Page 12)</li> </ul>
Widescreen video appears vertically stretched, or black bands appear at the top and bottom of the screen.	<ul style="list-style-type: none"> <li>• Is "TV Aspect Ratio" set to match the connected TV? (Page 37)</li> <li>• If you are using a widescreen TV, is the "TV Aspect Ratio" set to "Wide"? (Page 37)</li> </ul>
Square noise (mosaic) appears on the screen.	<ul style="list-style-type: none"> <li>• Blocks in images may be visible in scenes with rapid movement due to the characteristics of digital image compression technology.</li> </ul>
Audio is not output, or images are not played back properly.	<ul style="list-style-type: none"> <li>• The audio may not be output or the images may not be played back properly for some discs in which copyright-protected contents are recorded.</li> </ul>
3D images cannot be output to a TV.	<ul style="list-style-type: none"> <li>• Is an HDMI cable used?</li> <li>• Are a 3D compatible TV and 3D glasses used?</li> <li>• Is a proper connection made between the HDMI OUT terminal of the player and the HDMI input terminal of the 3D compatible TV?</li> <li>• Is the 3D setting on this player correct? (Pages 23, 39)</li> <li>• Is the 3D setting on the TV correct?</li> <li>• Is a 3D compatible BD disc being played back?</li> </ul>
Noise appears on the screen.	<ul style="list-style-type: none"> <li>• When you watch TV broadcasts with the power of this player turned on, noise may appear on the TV screen. In such cases, turn off the power to this player or keep this player away from the TV.</li> </ul>

### Sound

Problem	Possible causes and solutions
No sound, or sound is distorted.	<ul style="list-style-type: none"> <li>• If the volume of the TV or amplifier is set to minimum, turn the volume up.</li> <li>• There is no sound during still mode, slow motion playback, fast forward and fast reverse. (Page 31)</li> <li>• Check that the audio cable is connected correctly. (Page 18)</li> <li>• Check that the cable plugs are clean.</li> <li>• Take out the disc and clean it. (Page 12)</li> <li>• Audio may not be output depending on the audio recording status, such as when audio other than an audio signal or non-standard audio is recorded for the audio content of the disc. (Page 8)</li> </ul>
Audio is not output, or images are not played back properly.	<ul style="list-style-type: none"> <li>• The audio may not be output or the images may not be played back properly for some discs in which copyright-protected contents are recorded.</li> </ul>

## Troubleshooting

### Network

Problem	Possible causes and solutions
Cannot connect to the Internet.	<p><b>When the wired Internet connection is made</b></p> <ul style="list-style-type: none"> <li>Is the LAN cable connected properly?</li> <li>Is the wrong cable such as a modular cable used? Connect a LAN cable to the ETHERNET terminal. (Page 19)</li> <li>Is the power for the connected equipment, such as a broadband router or modem turned on?</li> <li>Is the broadband router and/or modem properly connected?</li> <li>Is the proper value(s) set in the network setting? Check "Communication Setup". (Pages 40-41)</li> </ul>
Cannot download BD-LIVE contents.	<ul style="list-style-type: none"> <li>Make sure that this player is connected to the Internet.</li> <li>Is the USB memory device properly connected? Check that the USB memory device is connected to the USB terminal of this Player.</li> <li>Check if the BD disc supports BD-LIVE.</li> <li>Check the setting for "BD Internet Access". (Page 39)</li> </ul>

### Other

Problem	Possible causes and solutions
The TV operates incorrectly.	<ul style="list-style-type: none"> <li>Some TVs with wireless remote control capability may operate incorrectly when using the remote control of this Player. Use such TVs away from this Player.</li> </ul>
The Player heats up during use.	<ul style="list-style-type: none"> <li>When using this Player, the console cabinet may heat up depending on the usage environment. This is not a malfunction.</li> </ul>
⏻ (On/Standby) indicator will remain lit.	<ul style="list-style-type: none"> <li>When the AC cord is removed from the outlet, the ⏻ (On/Standby) indicator will remain lit for a short period. This is normal and is not a malfunction.</li> </ul>

### To Reset this Player

- If this Player receives strong interference from a source such as excessive static electricity, strong external noise, malfunction of power supply, or voltage caused by lightning during use or a wrong operation is sent to the Player, errors like the Player not accepting an operation may occur.

Press and hold ⏻ on the Player until the ⏻ (On/Standby) indicator disappears.

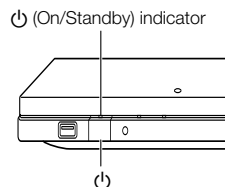

- When a reset is performed while the power is on, the Player will turn off. Turn the power on again. At this point, it may take a few moments for the system processing to finish before the Player is ready for use.
- Since all settings including the language setting stored in memory are also reset when a reset has been performed, they must be set again.
- When the problem persists even after performing a reset, unplug the AC cord and plug it in again. If this does not solve the problem, contact the nearest service centre approved by Kenwood.



# On-screen Error Messages

The following messages appear on the TV screen in case of an error during operation.

Error message	Possible Error	Suggested Solution
Cannot play.	<ul style="list-style-type: none"> <li>The disc cannot be played back with this Player.</li> </ul>	<ul style="list-style-type: none"> <li>Check the disc, and load it correctly.</li> </ul>
Incompatible disc.	<ul style="list-style-type: none"> <li>If you load a disc which cannot be played with this Player (i.e. a scratched disc), or if you load a disc upside down, this message will appear, and the disc will automatically pop out.</li> </ul>	
	<ul style="list-style-type: none"> <li>Occurs if the loaded disc cannot be played because it is a non-standard disc or scratched, etc.</li> </ul>	<ul style="list-style-type: none"> <li>Remove the disc.</li> </ul>
Cannot operate.	<ul style="list-style-type: none"> <li>Occurs if an operation is incorrect.</li> </ul>	
This USB memory is not formatted properly. Please format the memory in USB memory management.	<ul style="list-style-type: none"> <li>Occurs if there is a formatting error.</li> <li>Occurs if the USB memory is not formatted with FAT 32/16.</li> </ul>	<ul style="list-style-type: none"> <li>Format the USB memory again.</li> <li>Format the USB memory with your PC.</li> </ul>
The Connected USB Memory cannot be used. It should be compliant with USB 2.0	<ul style="list-style-type: none"> <li>Occurs if USB memory not compliant with USB 2.0 High Speed (480Mbit/s) is used (i.e. USB 1.0/USB 1.1).</li> </ul>	<ul style="list-style-type: none"> <li>Connect USB 2.0 High Speed (480Mbit/s) compliant USB memory.</li> </ul>

# Specifications

Specifications are subject to change without notice.

## General

Power requirements	DC 12V, 2A (with the supplied AC adapter)
Power consumption (Normal)	17 W (with the supplied AC adapter at AC 230V, 50Hz) Power is automatically shut off if playback is stopped and you do not perform any operations for about 10 minutes. (When "Auto Power Off" is set to "Yes")
Power consumption (Standby)	0.5 W (with the supplied AC adapter at AC 230V, 50Hz)
Dimensions	Approx. 430 mm × 36 mm × 218 mm (W × H × D)
Weight	Approx. 2.3 kg
Operating temperature	5°C to 35°C
Storage temperature	-20°C to 60°C
Operating humidity	10 % to 80 % (no condensation)
TV systems	PAL system/NTSC system (The system recorded on the disc is output.)

## Playback

Playable discs	BD-ROM, BD-RE, BD-R, DVD Video, DVD+RW/+R/-RW/-R (Video/VR/AVCHD/JPEG file/MP3 file/DivX format), Audio CD (CD-DA), CD-RW/R (CD-DA/JPEG file/MP3 file/DivX format)
Region code	B or ALL for BD, 2 or ALL for DVD

## Input/Output

HDMI	HDMI 19-pin standard connector (1080p 24Hz output) HDMI® (Deep Colour, x.v.Colour, Dolby TrueHD, DTS-HD Master Audio   Essential)
Digital audio optical output	Terminal: Square Optical terminal
USB input	USB 2.0 High Speed (480Mbit/s) correspondence (for Local storage/Software update/JPEG, MP3 and DivX playback) USB Memory device: Minimum memory capability 2GB or greater
ETHERNET	10BASE-T/100BASE-TX

## AC Adapter

Power requirements	AC 100–240V, 50/60Hz
Rated output	DC 12V, 5A

# Glossary

---

## **AVCHD (page 8)**

AVCHD (Advanced Video Codec High Definition) refers to a recording format (specification) for digital video cameras which can record to a disc such as 8 cm DVD disc and play back digital high definition images.

## **BD-RE (page 8)**

BD-RE (Blu-ray Disc Recordable) is a recordable, write-once Blu-ray Disc. Since contents can be recorded and cannot be overwritten, a BD-RE can be used to archive data or for storing and distributing video material.

## **BD-LIVE (page 26)**

BD-LIVE (Blu-ray Disc Live) is a recording format equivalent to DVD-VR (VR mode) of the DVD specifications.

## **BD-R (pages 8, 24)**

BD-R (Blu-ray Disc Recordable) is a recordable, write-once Blu-ray Disc. Since contents can be recorded and cannot be overwritten, a BD-R can be used to archive data or for storing and distributing video material.

## **BD-RE (pages 8, 24)**

BD-RE (Blu-ray Disc Recordable) is a recordable, write-once Blu-ray Disc. Since contents can be recorded and cannot be overwritten, a BD-RE can be used to archive data or for storing and distributing video material.

## **BD-ROM**

BD-ROMs (Blu-ray Disc Read-Only Memory) are commercially produced discs. Other than conventional movie and video contents, these discs have enhanced features such as interactive content, menu operations using pop-up menus, selection of subtitle display, and slide shows. Although a BD-ROM may contain any form of data, most BD-ROM discs will contain movies in High Definition format for playback on Blu-ray Disc players.

## **Blu-ray Disc (BD) (page 8)**

A disc format developed for recording/playing high-definition (HD) video (for HDTV, etc.), and for storing large amounts of data. A single layer Blu-ray Disc holds up to 25 GB, and a dual-layer Blu-ray Disc holds up to 50 GB of data.

## **Chapter number (pages 34, 35)**

Sections of a movie or a music feature that are smaller than titles. A title is composed of several chapters. Some discs may only be comprised of a single chapter.

## **Copy guard**

This function prevents copying. You cannot copy discs marked by the copyright holder with a signal which prevents copying.

## **Deep Colour**

Deep Colour can reproduce rich colours, increasing the number of bits describing colours. This Player is compatible with Deep Colour. You can enjoy this function by connecting to a Deep Colour compatible TV using an HDMI cable.

## **Disc menu (page 25)**

This lets you select things like the subtitle language or audio format using a menu stored on the DVD video disc.

## **Dolby Digital**

A sound system developed by Dolby Laboratories Inc. that gives movie theatre ambience to audio output when the product is connected to a Dolby Digital processor or amplifier.

## **Dolby Digital Plus**

A sound system developed as an extension to Dolby Digital. This audio coding technology supports 7.1 multi-channel surround sound.

## **Dolby TrueHD**

Dolby TrueHD is a lossless coding technology that supports up to 8 channels of multi-channel surround sound for the next generation optical discs. The reproduced sound is true to the original source bit-for-bit.

## **DTS**

This is a digital sound system developed by DTS, Inc. for use in cinemas.

## **DTS-HD High Resolution Audio**

DTS-HD High Resolution Audio is a new technology developed for the next generation high definition optical disc format.

## **DTS-HD Master Audio**

DTS-HD Master Audio is a lossless audio compression technology developed for the next generation high definition optical disc format.

## **DTS-HD Master Audio | Essential**

DTS-HD Master Audio | Essential is a lossless audio compression technology developed for the next generation high definition optical disc format.

## **DVD upscaling (page 24)**

Upscaling (upconverting) refers to a function of various players and devices that enlarge the image size to fit the size of the screen of video equipments such as a TV.

### **DVD video (pages 8, 24)**

A disc format that contains up to eight hours of moving pictures on a disc the same diameter as a CD. A single-layer single-sided DVD holds up to 4.7 GB; a double-layer single-sided DVD, 8.5 GB; a single-layer double-sided DVD, 9.4 GB; double-layer double-sided DVD, 17 GB. The MPEG 2 format was adopted for efficient video data compression. It is a variable rate technology that encodes the data to according to the status of the video for reproducing high-quality images. Audio information is recorded in a multi-channel format such as Dolby Digital, allowing for a realistic audio presence.

### **DVD+/-R (pages 8, 24)**

A DVD+/-R is a recordable, write-once DVD. Since contents can be recorded and cannot be overwritten, a DVD+/-R can be used to archive data or for storing and distributing video material. The DVD+/-R has two different formats: VR format and Video format. DVDs created in Video format have the same format as a DVD video, while discs created in VR (Video Recording) format allow the contents to be programmed or edited.

### **DVD+/-RW (pages 8, 24)**

A DVD+/-RW is a recordable and rewritable DVD. The re-recordable feature makes editing possible. The DVD+/-RW has two different formats: VR format and Video format. DVDs created in Video format have the same format as a DVD video, while discs created in VR (Video Recording) format allow the contents to be programmed or edited.

### **HDMI (page 17)**

HDMI (High-Definition Multimedia Interface) is an interface that supports both video and audio on a single digital connection. The HDMI connection carries standard to high definition video signals and multi-channel audio signals to AV components such as HDMI equipped TVs, in digital form without degradation.

### **Interlace format**

Interlace format shows every other line of an image as a single "field" and is the standard method for displaying images on television. The even numbered field shows the even numbered lines of an image, and the odd numbered field shows the odd numbered lines of an image.

### **JPEG (pages 8, 9, 10, 30)**

JPEG (Joint Photographic Experts Group) is a still image data compression format and is used in most of digital cameras.

### **Letter Box (LB 4:3) (page 37)**

A screen size with black bars on the top and bottom of the image to allow viewing of wide-screen (16:9) material on a connected 4:3 TV.

### **Linear PCM Sound**

Linear PCM is a signal recording format used for Audio CDs and on some DVD and Blu-ray discs. The sound on Audio CDs is recorded at 44.1 kHz with 16 bits. (Sound is recorded between 48 kHz with 16 bits and 96 kHz with 24 bits on DVD video discs and between 48 kHz with 16 bits and 192 kHz with 24 bits on BD video discs.)

### **MP3 (pages 8, 9, 10, 29)**

MP3 files are audio data compressed in the MPEG1/2 Audio layer-3 file format. "MP3 files" have ".mp3" as extensions.

### **MPEG-2**

MPEG-2 (Moving Picture Experts Group phase 2) is one of the video data compression schemes, which is adopted for DVD videos and digital broadcasts worldwide. Some Blu-ray Discs also use high bitrate MPEG-2.

### **Multi Angle (pages 33–35)**

This is a feature of DVD and BD video discs. In some discs, the same scene is shot from different angles, and these are stored in a single disc so you can enjoy playback from each angle. (This function can be enjoyed if the disc is recorded with multiple angles.)

### **Multi Audio**

This is a feature of DVD and BD video discs. This function makes it possible to record different audio tracks for the same video, so you can enhance your enjoyment by switching the audio. (You can enjoy this function with discs recorded with multiple audio tracks.)

### **Pan Scan (PS 4:3) (page 37)**

A screen size that cuts off the sides of the image to allow viewing of wide-screen (16:9) material on a connected 4:3 TV.

### **Parental control (page 38)**

In some digital broadcasts and BD/DVD video discs, a control level for disc viewing is set depending on the age of the viewer. With this Player, you can set the control level for viewing such broadcasts and discs.

### **Pop-up menu (page 25)**

An enhanced menu operation available on BD video discs. The pop-up menu appears when **POP-UP MENU** is pressed during playback, and can be operated while playback is in progress.

### **Progressive format**

Compared to the Interlace format that alternately shows every other line of an image (field) to create one frame, the Progressive format shows the entire image at once as a single frame. This means that while the Interlace format can show 30 frames/60 fields in one second, the Progressive format can show 60 frames in one second. The overall picture quality increases and still images, text, and horizontal lines appear sharper.

## Glossary

---

### **Region code (page 8)**

Code identifying a geographic region of compatibility for a BD/DVD.

### **Resume playback (page 24)**

If you stop playback while it is in progress, the Player stores the stop position in memory, and this function lets you playback from that point.

### **Skip (pages 28, 29, 31)**

This returns to the start of the chapter (or track) being played, or skips to the next chapter (or track).

### **Subtitles (pages 33–35)**

These are the lines of text appearing at the bottom of the screen which translate or transcribe the dialogue. They are recorded on many DVD and BD video discs.

### **Time number**

This indicates the play time which has elapsed from the start of a disc or a title. It can be used to find a specific scene quickly. (It may not work with some discs.)

### **Title number (pages 34, 35)**

These numbers are recorded on DVD and Blu-ray discs. When a disc contains two or more movies, these movies are numbered as title 1, title 2, etc.

### **Top menu (page 25)**

In a BD/DVD video, this is the menu for selecting things like the chapter to be played back and the subtitle language. In some DVD videos, the top menu may be called the "Title Menu".

### **Track number (pages 34, 35)**

These numbers are assigned to the tracks which are recorded on audio CDs. They enable specific tracks to be located quickly.

### **x.v.Colour**

x.v.Colour reproduces a greater range of colour than before, showing almost all of the colours that the human eye can detect. (Applicable for JPEG files only with this system)

# About Software License

---

## Information on the Software License for This Product

### Software composition

The software included in this product is comprised of various software components whose individual copyrights are held by Kenwood or by third parties.

### Software developed by Kenwood and open source software

The copyrights for the software components and various relevant documents included with this product that were developed or written by Kenwood are owned by Kenwood and are protected by the Copyright Act, international treaties, and other relevant laws. This product also makes use of freely distributed software and software components whose copyrights are held by third parties. These include software components covered by a GNU General Public License (hereafter GPL), a GNU Lesser General Public License (hereafter LGPL) or other license agreement.

### Obtaining source code

Some of the open source software licensors require the distributor to provide the source code with the executable software components. GPL and LGPL include similar requirements. For information on obtaining the source code for the open source software and for obtaining the GPL, LGPL, and other license agreement information, visit the following website:

<http://www.kenwood.co.jp/gpl/>

We are unable to answer any questions about the source code for the open source software. The source code for the software components whose copyrights are held by Kenwood is not distributed.

### Acknowledgements

The following open source software components are included in this product:

• directfb-extra • cairo • directfb • iconv • openssl • curl • freetype • jpeg • expat • mng • png • xml • zlib • kernel • net-tools  
• GNU bash • busybox • crams • dhcpcd • e2fsprogs • fdisk • TinyLogin • sysutils • iptables • mtd-utils • nfs-3g • sfdisk • hotplug  
• utelnetd • procps • GNU termcap • libusb • uClibc • tcpdump • strace • hdparm • libpcap • portmap

## Software License Notice

### Software License Notice Requirements

The software components incorporated into this product include components whose copyright holders require license notices. The license notices for these software components are shown below.

#### OpenSSL License

This product includes software developed by the OpenSSL Project for use in the OpenSSL Toolkit. (<http://www.openssl.org>)

#### Original SSLeay License

This product includes cryptographic software written by Eric Young ([ey@cryptsoft.com](mailto:ey@cryptsoft.com)).

#### BSD License

This product includes software developed by the University of California, Berkeley and its contributors.

---

**KENWOOD**