

KENWOOD

COMPACT HI-FI COMPONENT SYSTEM

R-K731

INSTRUCTION MANUAL

JVC KENWOOD Corporation

CE Declaration of Conformity with regard to
the EMC Directive 2004/108/EC

Manufacturer:

JVC Kenwood Corporation
3-12 Moriya-cho, Kanagawa-ku, Yokohama-shi, Kanagawa, 221-0022 Japan

EU Representative's:

Kenwood Electronics Europe BV
Amsterdamseweg 37, 1422 AC UITHOORN, The Netherlands

Made for

 iPod  iPhone

COMPACT
disc
DIGITAL AUDIO

CD-R/RW
PLAYBACK



AAC
MP3
WMA

WAV

DSP
PERFORMANCE AUDIO

© B60-5877-08/00 (E) LVT2280-002A

Safety Precautions



	THE LIGHTNING FLASH WITH ARROWHEAD SYMBOL, WITHIN AN EQUILATERAL TRIANGLE, IS INTENDED TO ALERT THE USER TO THE PRESENCE OF UNINSULATED "DANGEROUS VOLTAGE" WITHIN THE PRODUCT'S ENCLOSURE THAT MAY BE OF SUFFICIENT MAGNITUDE TO CONSTITUTE A RISK OF ELECTRIC SHOCK TO PERSONS.
	THE EXCLAMATION POINT WITHIN AN EQUILATERAL TRIANGLE IS INTENDED TO ALERT THE USER TO THE PRESENCE OF IMPORTANT OPERATING AND MAINTENANCE (SERVICING) INSTRUCTIONS IN THE LITERATURE ACCOMPANYING THE APPLIANCE.

Before Applying Power

 **Caution:** Read this page carefully to ensure safe operation.

Safety precautions

WARNING : TO PREVENT FIRE OR ELECTRIC SHOCK, DO NOT EXPOSE THIS APPLIANCE TO RAIN OR MOISTURE.

	CAUTION RISK OF ELECTRIC SHOCK DO NOT OPEN	
CAUTION: TO REDUCE THE RISK OF ELECTRIC SHOCK, DO NOT REMOVE COVER (OR BACK). NO USER-SERVICEABLE PARTS INSIDE. REFER SERVICING TO QUALIFIED SERVICE PERSONNEL.		

The marking of products using lasers

**CLASS 1
LASER PRODUCT**

The marking this product has been classified as Class 1. It means that there is no danger of hazardous radiation outside the product.

Location: Back panel

IMPORTANT SAFETY INSTRUCTIONS

 **Caution: Read this page carefully to ensure safe operation.**

Read These Instructions

– All the safety and operating instructions should be read before the product is operated.

Keep These Instructions

– The safety and operating instructions should be retained for future reference.

Heed All Warnings

– All warnings on the product and in the operating instructions should be adhered to.

Follow All Instructions

– All operating and use instructions should be followed.

1. Clean only with dry cloth

– Unplug this product from the wall outlet before cleaning. Do not use liquid cleaners or aerosol cleaners. Use a damp cloth for cleaning.

2. Attachments

– Only use attachments/accessories specified by the manufacturer.

3. Do not use this apparatus near water

– This product shall not be exposed to dripping and splashing – for example, near a bath tub, wash bowl, kitchen sink, or laundry tub; in a wet basement; or near a swimming pool; and the like. Do not place an object containing liquid, such as a flower vase, on the appliance.

4. Accessories

– Use only with the cart, stand, tripod, bracket, or table specified by the manufacturer, or sold with the apparatus. When a cart is used, use caution when moving the cart/apparatus combination to avoid injury from tip-over.



5. Ventilation

– Slots and openings in the cabinet are provided for ventilation and to ensure reliable operation of the product and to protect it from overheating. Do not block any ventilation openings. Install in accordance with the manufacturer's instructions. The openings should never be blocked by placing the product on a bed, sofa, rug, or other similar surface. This product should not be placed in a built-in installation such as a bookcase or rack unless proper ventilation is provided or the manufacturer's instructions have been adhered to.

6. Power Sources

– This product should be operated only from the type of power source indicated on the product. If you are not sure of the type of power supply to your home, consult your product dealer or local power company.

7. CAUTION – Polarization

– Do not defeat the safety purpose of the polarized or grounding-type plug. A polarized plug has two blades with one wider than the other. A grounding type plug has two blades and a third grounding prong. The wide blade or the third prong are provided for your safety. If the provided plug does not fit into your outlet, consult an electrician for replacement of the obsolete outlet.

8. Power Cord Protection

– Protect the power cord from being walked on or pinched particularly at plugs, convenience receptacles, and the point where they exit from the apparatus.

Continued to next page 

English

3

IMPORTANT SAFETY INSTRUCTIONS

9. Lightning

– Unplug this apparatus during lightning storms or when unused for long periods of time.

10. Overloading

– Do not overload wall outlets, extension cords, or integral convenience receptacles as this can result in a risk of fire or electric shock.

11. Object and Liquid Entry

– Never push objects of any kind into this product through openings as they may touch dangerous voltage points or short-out parts that could result in a fire or electric shock. Never spill liquid of any kind on the product.

12. Servicing

– Do not attempt to service this product yourself as opening or removing covers may expose you to dangerous voltage or other hazards. Refer all servicing to qualified service personnel.

13. Damage Requiring Service

– Refer all servicing to qualified service personnel. Servicing is required when the apparatus has been damaged in any way, such as power-supply cord or plug is damaged, liquid has been spilled or objects have fallen into the apparatus, the apparatus has been exposed to rain or moisture, does not operate normally, or has been dropped.

14. Replacement Parts

– When replacement parts are required, be sure the service technician has used replacement parts specified by the manufacturer or have the same characteristics as the original part. Unauthorized substitutions may result in fire, electric shock, or other hazards.

15. Safety Check

– Upon completion of any service or repairs to this product, ask the service technician to perform safety checks to determine that the product is in proper operating condition.

16. Wall or Ceiling Mounting

– This product should be mounted to a wall or ceiling only as recommended by the manufacturer.

17. Heat

– Do not install near any heat sources such as radiators, heat registers, stoves, or other apparatus (including amplifiers) that produce heat. Do not place a flaming object, such as a candle or lantern, or near the product.

18. Power Lines

– An outside antenna system should not be located in the vicinity of overhead power lines or other electric light or power circuits, or where it can fall into such power lines or circuits. When installing an outside antenna system, extreme care should be taken to keep from touching such power lines or circuits as contact with them might be fatal.

Notes:

Item 7 is not required except for grounded or polarized equipment.

Information on Disposal of Old Electrical and Electronic Equipment and Batteries (applicable for EU countries that have adopted separate waste collection systems)



Products and batteries with the symbol (crossed-out wheeled bin) cannot be disposed as household waste.



Pb

Old electrical and electronic equipment and batteries should be recycled at a facility capable of handling these items and their waste byproducts.

Contact your local authority for details in locating a recycle facility nearest to you.

Proper recycling and waste disposal will help conserve resources whilst preventing detrimental effects on our health and the environment.

Notice: The sign "Pb" below the symbol for batteries indicates that this battery contains lead.

What the R-K731 Can Do



Various recording formats

Disc Playback

As well as music CDs, the system will also play discs containing recorded audio files (MP3/WMA/AAC).



High-quality sound reproduction of iPod/iPhone music

iPod/iPhone Playback Function

With this system, the amplifier receives digital signals of iPod/iPhone music as input. This realizes the reproduction of high-quality sound minimizing the deterioration of sound quality.



Supports for USB connection, PC connection, analog input and digital input

External Input

The system supports the playback of a USB flash memory and USB mass storage class compliant digital audio player. In addition, as well as analog input terminals for cassette decks and PC input terminal for playing its contents, the R-K731 also features a sampling rate converter compliant digital input terminal for digital tuners etc.



Choose your favorite audio quality

Digital Signal Processor Function

This includes "TONE", which you can use to select detailed audio characteristics for the low-, mid- and high-range bands, as well as "D-BASS", which allows you to adjust super-bass effect.

Contents



To ensure safety, read the items by this mark carefully.

Before Using the System

Be sure to read these precautions.

Safety Precautions.....	2
Accessories	8
Installing the System	9
Connecting the System	10
Component Names and Functions	14
How to Use This Manual.....	18
Basic Operation	20
Important Information	22

Procedures by Input Source ▶▶ P.25

This chapter explains how to connect and use the system with the different input sources.

- CD
- iPod/iPhone
- USB
- Receiving Radio Broadcasts
- Radio Data System
- PC
- External Components
- D.AUDIO



Audio Settings ▶▶ P.51

This chapter explains how to tailor the system to your audio preferences.

- Digital Signal Processor
- Supreme EX
- Balance
- Rec Out Level



Component Settings ▶▶ P.59

This chapter explains how to select the settings for the system.

- Setting the System Clock
- Setting the Timer
- Display Settings
- Auto Power Save (A.P.S.)



Maintenance ▶▶ P.69

This chapter explains how to store and maintain your system so that it continues to give pleasure for many years to come.

- Messages
- Glossary of Terms
- Troubleshooting
- Care and Storage
- Specifications



Accessories

Check that all accessories are present in the package.

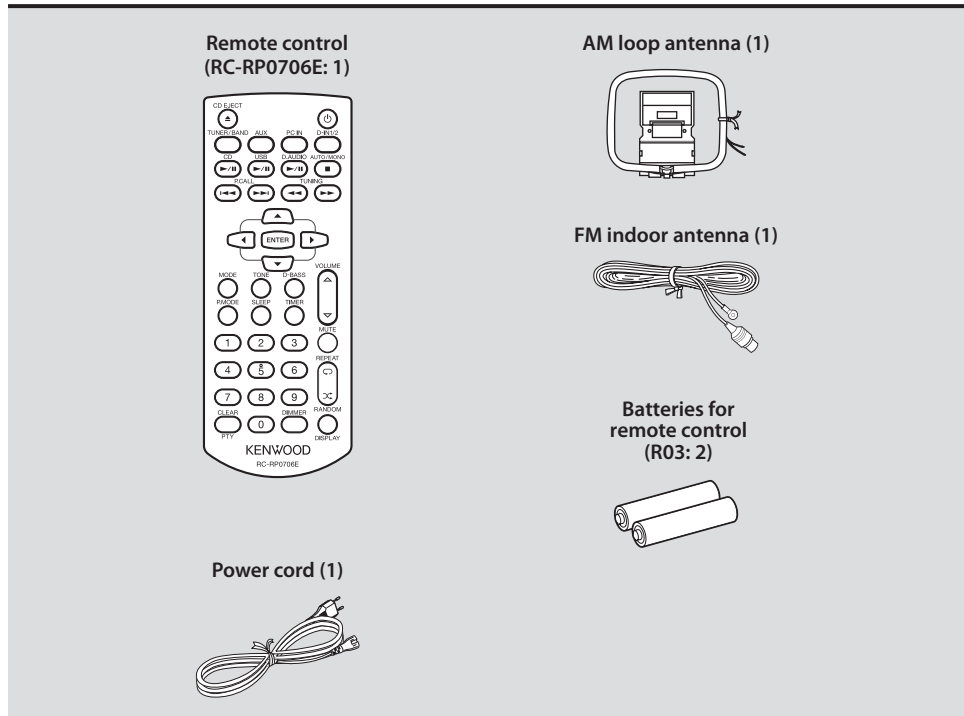

If any accessories are missing, or if the unit is damaged or fails to operate, notify your dealer immediately. If the unit was shipped to you directly, notify your shipper immediately. Kenwood recommends that you retain the original carton and packing materials in case you need to move or ship the unit in the future. Keep this manual handy for future reference.

Installing the System

Notes on installing the system

- Always install the system on a flat, stable surface. When installing the system on a stand of some sort, be sure to check the strength of the stand.
- The magnets used in the speakers may cause color irregularities on TV or PC screens. Do not set up the speakers too close to a TV or PC.

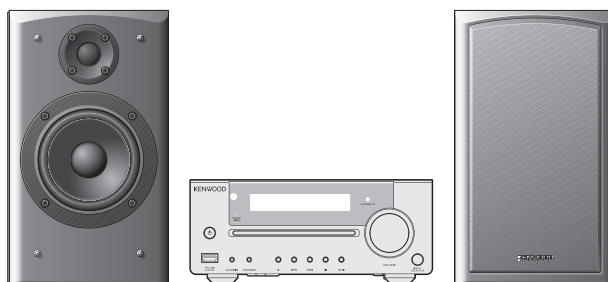

Left speaker

Main unit

Right speaker

CAUTION

Observe the following cautions when installing the system. Insufficient heat radiation may build up internal heat and cause a malfunction or fire hazard.

- Do not place any object on the system that may hinder heat radiation.
- Do not place the system upside-down or lay it on its side.
- Do not cover the system with a cloth or place it on a carpet or blanket.
- Do not place the system in a narrow space that hinders the ventilation.
- Leave the spaces specified below around the cabinets of the main unit.

Top panel: 50 cm or more
Side panel: 10 cm or more
Back panel: 10 cm or more

Install the system so the power outlet is easily accessible, and unplug the power cord from the power outlet immediately in case of any trouble.

Note that the power supply to the system is not shut down completely by simply setting the power switch to OFF.

To shut down the power supply completely, unplug the power cord.

Getting the best acoustic effect

The sound will vary depending on the positioning of the speakers. To get the best possible sound quality, note the guidelines below.

- Ensure that the areas around the left and right speakers are as identical as possible. Set up the left and right speakers away from the wall and hang thick curtains on any windows to minimize echoes or reverberation.
- Place the left and right speakers as far apart as possible.
- Position the speakers at the same height as your ears when you are using the system.

Connecting the System

Main Connections

Ensure that all the cords are securely connected. Loose or incomplete connections may result in noise interference or no sound at all.

Caution for Connection

Do not plug the AC power cord into an AC wall outlet until all the connections are completed. Before disconnecting any cords or cables, always turn the system off and unplug the power cord from the AC wall outlet.

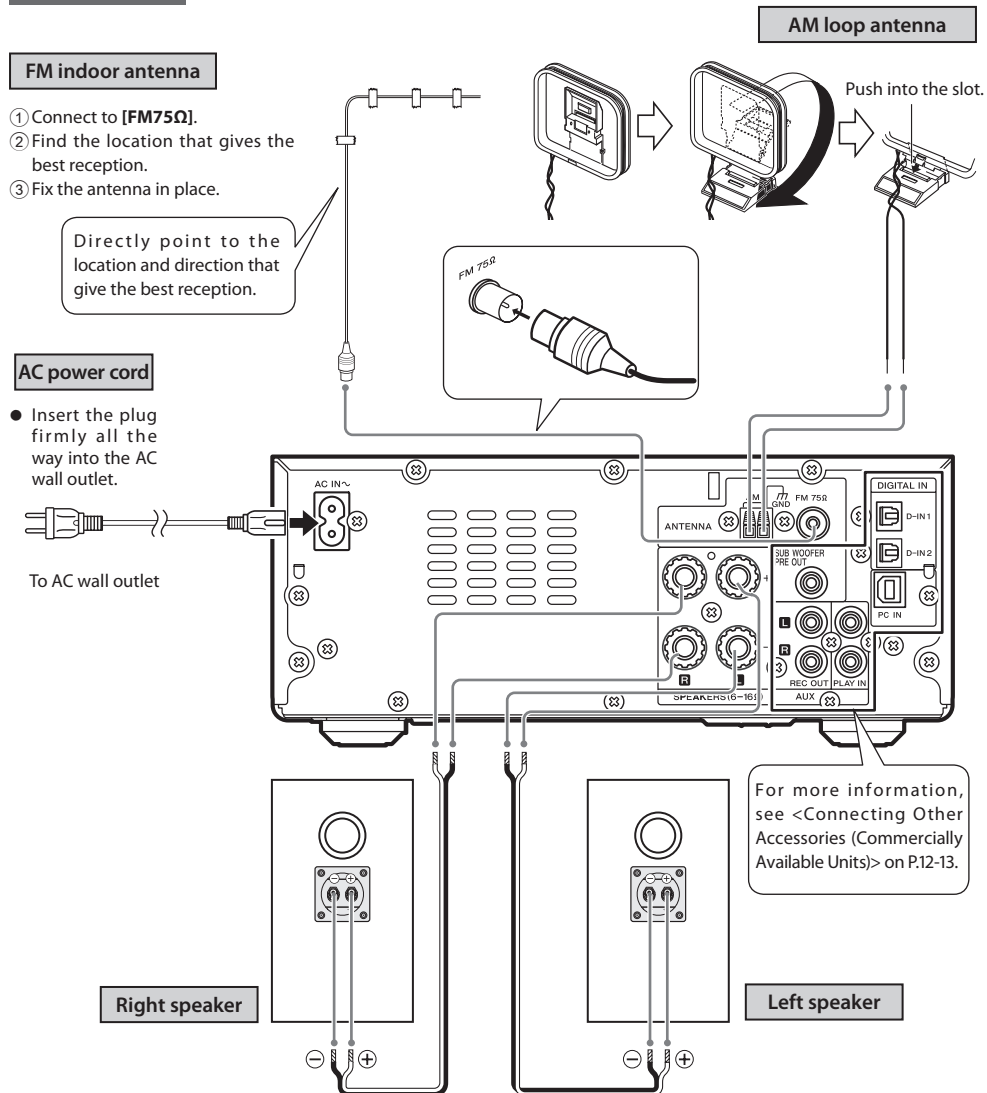

⚠ Caution for outdoor antenna installation

Since antenna installation requires skill and experience, always consult your dealer before installation. The antenna should be located away from power lines. If the antenna falls over, contact with a power line creates the risk of electric shock.

Microcomputer malfunctions

If the system is connected correctly and still does not operate normally or shows display errors, reset the microcomputer. (P.73)

Connecting the AM loop antenna

The antenna supplied with the system is for indoor use. Place it as far as possible away from the main unit, your TV set, the speaker cords and the power cord and point it in the direction that gives the best reception.

● **Connecting the antenna cord**

As shown on the right, connect the AM antenna cord to the **[AM]** terminal.

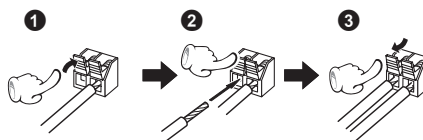

Connecting the FM indoor antenna

The antenna supplied with the system is a basic antenna for indoor use. For stable signal reception, the use of an outdoor antenna (commercially available) is recommended. To connect an outdoor antenna, first remove the indoor antenna.

Connecting the speakers

Notes on connecting the speaker cords

Never short-circuit the positive (+) and negative (-) ends of the speaker cords. (Do not touch the + and - cords together.) Mistakenly reversing the positive and negative polarity will result in unnatural sound and unclear sound.

● **Connecting the speaker cords to the main unit**



Connecting the System

Connecting Other Accessories (Commercially Available Units)



- When connecting a related system component, read the instruction manual that comes with the component too.
- Ensure that all the cords are securely connected. Loose or incomplete connections may result in noise interference or no sound at all.

USB

Connect a USB flash memory, USB mass storage class compliant digital audio players or an iPod/iPhone to the **[USB]** connector on the front panel of the main unit.

- The iPod/iPhone can be charged once it is connected when the main unit is turned on.
- For more information on which models of iPod/iPhone can be connected, see P.32.
- Depending on the device being connected, it may take some time for the system to recognize it.
- Some USB devices may not be recognized or cannot play certain files.
- With some models, a USB connection mode selection screen will appear. Select "Storage (MSC)" mode.

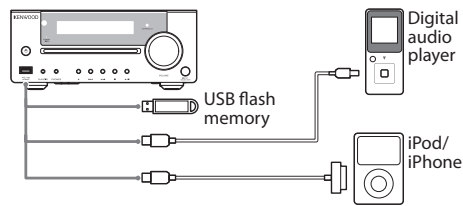

PC IN

Connect a PC running Windows® 7/Vista/XP and equipped with a USB terminal to the **[PC IN]** terminal.

Use a commercially available USB cable (Type A – Type B) for the connection.

- Use a USB cable with a length of no more than 3 m.

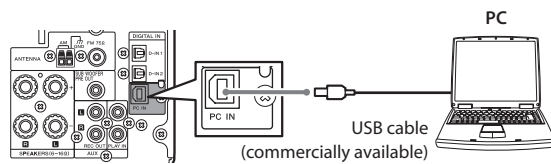

Types of USB Connectors

TypeA

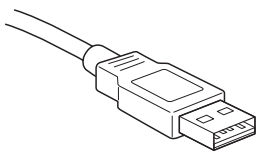

TypeB

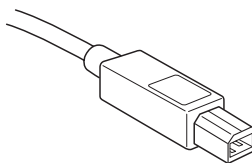

Mini-B

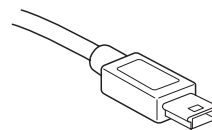

D.AUDIO

Connect digital audio players to the **[D.AUDIO]** terminal on the front panel of the main unit.

- If you connect a Kenwood player that supports digital audio link using the dedicated cable PNC-150 (sold separately), you can control the player from the main unit and the remote control. (P.48) Other portable players can be connected using a 3.5 mm stereo mini-plug cable (commercially available).
- When you are not using the digital audio player, unplug the mini-plug cable from the main unit.

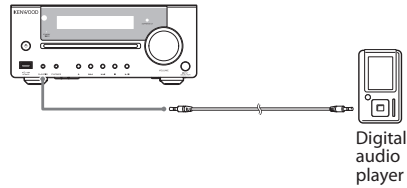

AUX PLAY IN/AUX REC OUT

Connect a cassette deck, etc. to the **[AUX PLAY IN]** or **[AUX REC OUT]** terminal on the rear panel of the main unit.

- **[AUX PLAY IN]** inputs an analog audio signal.
- **[AUX REC OUT]** outputs an analog audio signal.

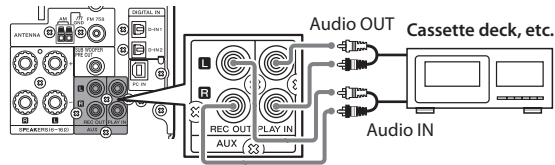

DIGITAL IN (PCM signals)

Connect the optical digital output terminals on components such as digital tuners to the **[DIGITAL IN]** terminal on the rear panel of the main unit.

- Set the digital audio output on connected components to "PCM".

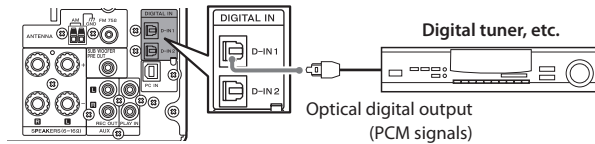

SUB WOOFER PRE OUT

Connect a subwoofer with a built-in amplifier (such as the optional SW-40HT/ sold separately) to the **[SUB WOOFER PRE OUT]** terminal on the rear panel of the main unit.

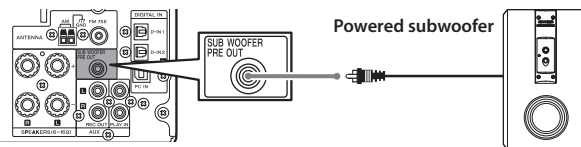

PHONES

Plug headphones equipped with a 3.5 mm stereo mini-plug into the **[PHONES]** jack on the front panel of the main unit.

- When headphones are connected, no sound will be output from the speakers.

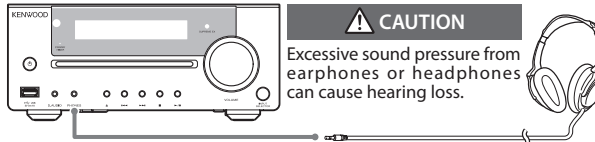

Component Names and Functions

Main unit

Power (P.21)

Turns the system on or off (Standby).

STANDBY/TIMER indicator

Red: Lights in normal Standby mode.
Orange: Lights in Timer Standby mode.

Remote sensor (P.17)

Display (P.15)

SUPREME EX indicator (P.56)

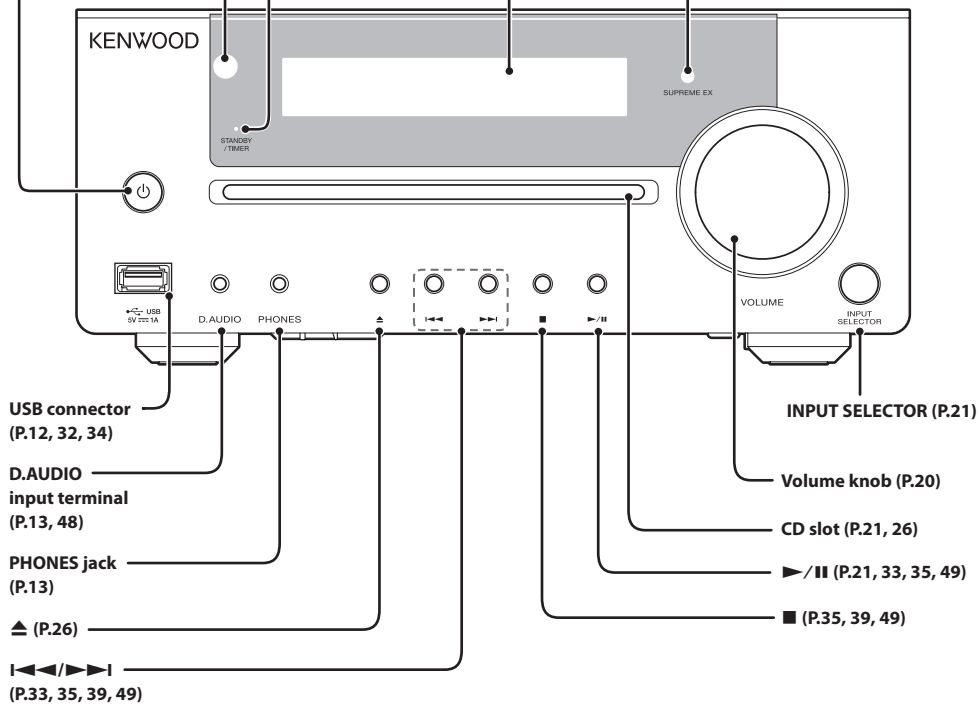

Standby Mode

While the [STANDBY/TIMER] indicator on the main unit is lit, the system is using very weak current to maintain the built-in memory. This is called Standby mode. When the main unit is in this mode, you can turn it on using the remote control.

One-touch Operation

This system features a convenient one-touch operation function. In Standby mode, pressing any of the following keys will turn on system power: [TUNER/BAND], [CD ►/II], [USB ►/II], [D.AUDIO ►/II], [PC IN], [D-IN1/2], or [AUX] of the remote control.

Display

Displays shown in this manual may differ from the actual displays.

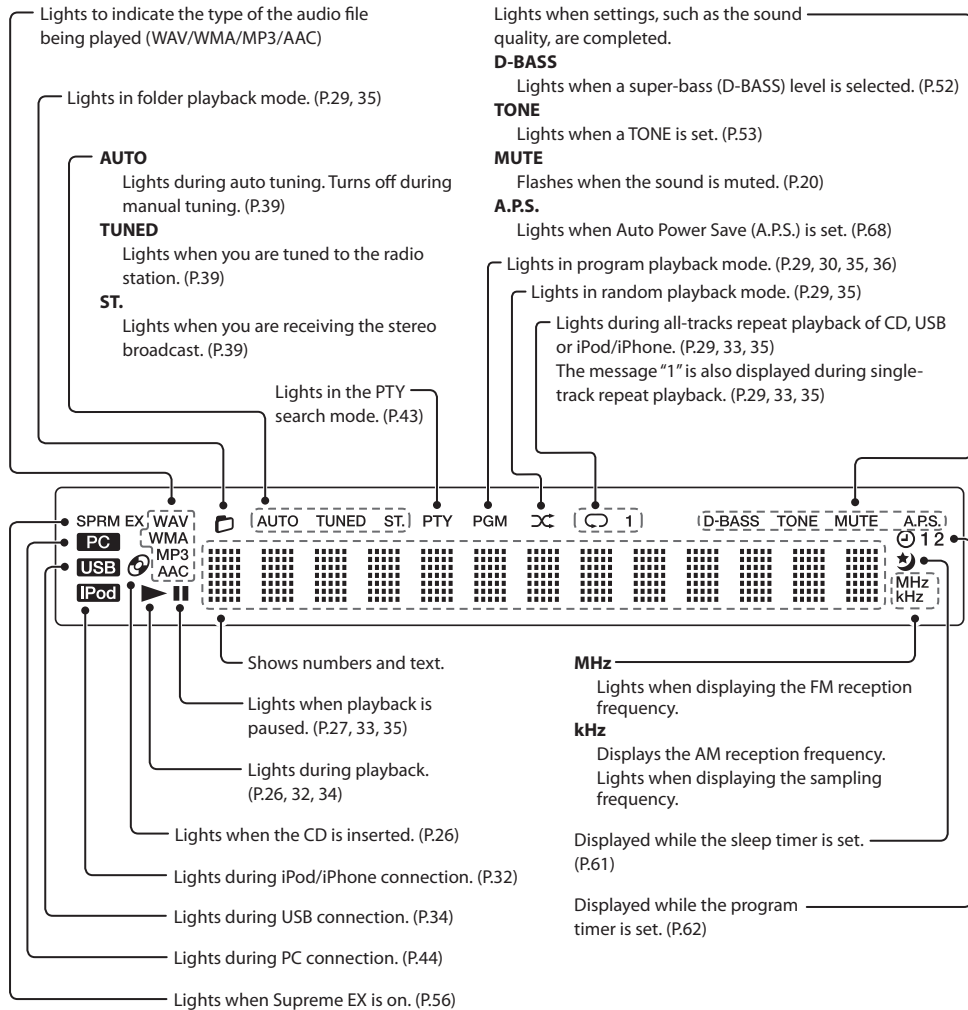

Remote control

Remote control keys with the same names as keys on the main unit have the same functions as the main unit keys.

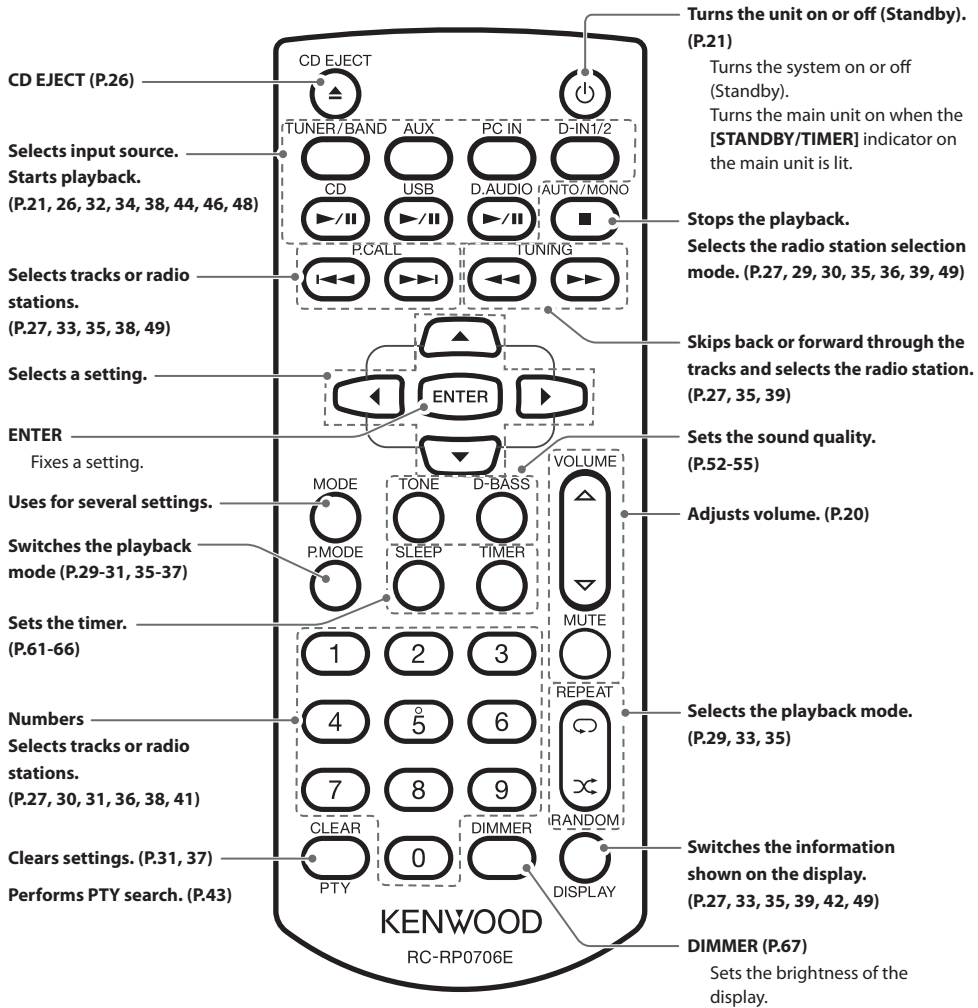

Using the remote control

After plugging the main unit into an AC wall outlet, press the power [⏻] key on the remote control to turn the system on. After the system powers up, press the key for the function you want to use. Point the remote control at the remote sensor when using it.

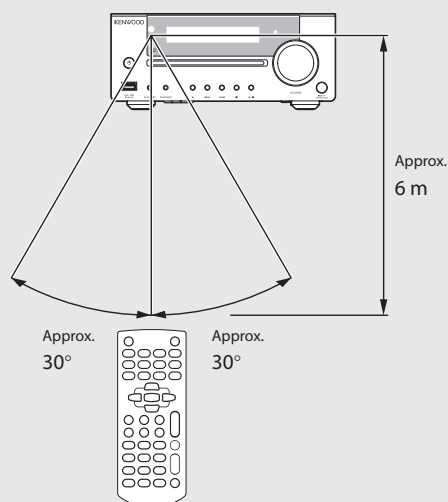

- The remote control may not operate correctly if direct sunlight or light from a high-frequency fluorescent lamp (such as an inverter type) is shining on the remote sensor. If this happens, move the system to a different location to avoid this type of malfunction.

Loading the remote control batteries

- 1 Remove the battery cover.

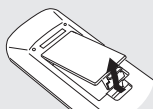

- 2 Load the AAA-size batteries supplied with the system.

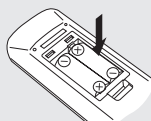

- 3 Close the battery cover.

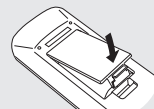

- Check the polarity of the batteries (+/-) when loading them.

- The batteries supplied with the system are for operational testing and may last only for a short time.
- When replacing the batteries, always load 2 new batteries.

CAUTION

Do not leave the battery near fire or under direct sunlight. A fire, explosion or excessive heat generation may result.

How to Use This Manual

Operation procedure

While this system can be controlled from either the remote control or the main unit, the explanations in this manual primarily describe operation procedures using the remote control.

Remote control keys used in the procedure

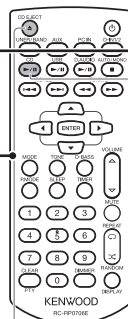

Display shown during or after an operation

- The displays shown in this instruction manual may differ from the actual displays.

CD

This section explains how to play a CD. As well as normal playback, you can use folder playback, random playback, repeat playback and program playback.

Playing a CD

Insert and play the CD.

- If a disc is already inserted, simply press the [CD▶/II] key to turn the system on and begin playback.

1 Insert the CD.

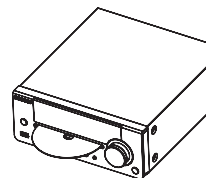

- Insert the disc with the label side facing upwards. The "Reading" message flashes while the unit is reading the information on the CD. When the installation of the disc is complete, the CD light turns on.

2 Press the [CD▶/II] key.

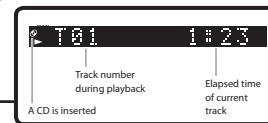

To eject the CD

- Stop playback and press the [CD EJECT] key on the remote control or the [EJECT] key on the main unit.



- Track numbers may not be displayed correctly when the following types of discs are played.
 - Discs recorded in multiple sessions

Explanations of main unit procedures

Explanations of remote control procedures

Related functions that may also be helpful

Related Information

- Adjusting the Digital Audio Player Input Level → P50
- Audio Settings → P51 onwards

■ Operations during digital audio player playback

Pausing and resuming playback

Press the [D.AUDIO] key.

Stopping playback

Press the [] key.

Skipping forward/backward

Hold down the [] or [] key.

Skipping tracks, skipping back, skipping to the start

Skip a track

Press the [] key.

Skip back to the previous track

Press the [] key two or more times in succession.

Return to the start of the track

Press the [] key once.

Selecting the folder

Press the [] or [] key.

Switching display contents

Press the [DISPLAY] key to shift the selection.

[D.AUDIO] Day/Clock

Resuming playback

Press the [] key.

Pressing the [] key.

Hold down the [] or [] key.

Press the [] key.











Hold down the [] or [] key.

Press the [] key.

Press the [] key two or more times in succession.

Press the [] key once.

Operation icons

-  Explains the procedure for CDs.
-  Explains how to operate the system when an iPod/iPhone is connected.
-  Explains how to operate the system when a USB device is connected.
-  Explains the procedure for the radio.
-  Explains how to operate the system when a PC is connected.
-  Explains how to operate the system when an external component is connected.
-  Explains the procedure for digital audio players.
-  Explains how to set the sound quality.
-  Explains how to set up component units.
-  Explains how to carry out system maintenance.

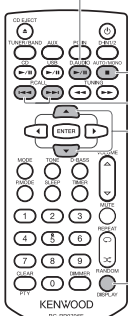

■ Operations during digital audio player playback

Pausing and resuming playback

Press the [D.AUDIO] key.

Resuming playback

Press the [] key.

Pressing the [] key.

Hold down the [] or [] key.

Press the [] key.

Hold down the [] or [] key.

Press the [] key.

Press the [] key two or more times in succession.

Press the [] key once.

Selecting the folder

Press the [] or [] key.

Switching display contents

Press the [DISPLAY] key to shift the selection.

[D.AUDIO] Day/Clock

- Skipping a folder is not possible if the playback is from a selection of tracks on the digital audio player.
- Some functions may not work depending on the connected component.

Basic Operation

This section describes some basic procedures for using the system, such as tuning the radio and playing audio from a CD, iPod/iPhone, PC IN, USB and a D.AUDIO.

Preparations

Check the connections. (P.10-13)
Have the remote control ready. (P. 17)

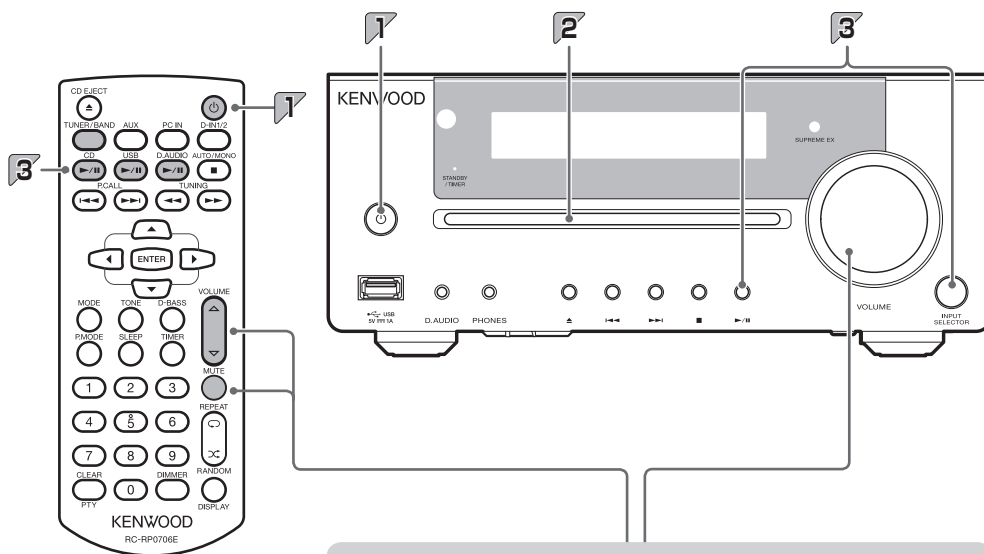

■ Adjusting the volume level



Lowers the volume



Increases the volume



VOLUME

Increases the volume

Lowers the volume

■ Mute



- Press this key again to unmute the sound.

1

Turn the system on (off).



- Pressing the [TUNER/BAND], [CD ▶/II], [USB ▶/II], [D.AUDIO ▶/II], [PC IN], [AUX] or [D-IN1/2] key on the remote control also turns on the power.
- Pressing the power [⏻] key when the system is on turns it off (Standby mode).

2

Insert a disc (when listening to a CD).

To use other components for playback, proceed to step 3.

Insert a CD with the label side upwards.

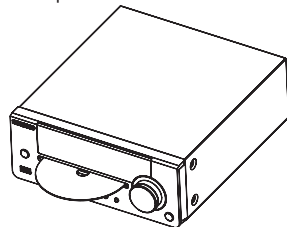

3

Start playback.

Press the Play/Pause key for the input source. See <Procedures by Input Source> (P.25-50) for details.



INPUT
SELECTOR



TUNER/BAND





- If you connect the external components to the [PC IN], [D-IN1] or [D-IN2] terminal, playback operation should be started on each component.

- You can select the sound quality you want. See <Audio Settings> (P.51-58) for details.

Important Information

Supported Media

Media	Icon in this manual	Explanation
USB USB flash memory USB mass storage class compliant digital audio player		<ul style="list-style-type: none"> Never connect any other device besides a USB flash memory, USB mass storage class compliant digital audio player or iPod/iPhone to the [USB] terminal. Note that Kenwood will not be held liable for any losses related to malfunction, damage, or data loss due to connection of any other type of device.
CD Commercially available music CDs CD-R/CD-RW discs recorded in CD-DA format MP3/WMA/AAC files recorded on CD-R/CD-RW discs		<ul style="list-style-type: none"> You may not be able to play discs that do not conform to the CD standard, such as Copy Control CDs. Discs must be finalized during writing. Depending on the equipment or recording mode used for recording onto a CD-R or CD-RW disc, and depending on the type of CD-R or CD-RW disc used, you may not be able to play the disc on this system.
PC Windows 7/Vista/XP machine equipped with USB terminal		<ul style="list-style-type: none"> Connect a PC running Windows 7/Vista/XP to the [PC IN] terminal using a USB cable (commercially available).

Precautions when writing data to media

- Discs recorded in Packet Write mode or UDF (Universal Disc Format) cannot be played.
 - When writing data to a disc, always close the session or finalize the disc. The disc may not play properly if you do not close the session or finalize the disc.
 - Depending on the specifications of the writing software used, the recorded folder names and file names may not be displayed correctly.
 - Playback for multi-session discs or discs that contain large numbers of folders may take longer to begin than for normal discs.
 - If you write audio files and music CD tracks (CD-DA format) to the same disc, the disc may not play correctly.
 - Before writing audio files to a disc, check that the files play back correctly on the PC being used to write the files. After you finish writing, check that the written files are played back correctly.
 - Use the correct file extensions (mp3, wma, m4a, wav) in the names of audio files. Files without file extensions will not play. Also, do not use audio file extensions (mp3, wma, m4a, wav) for files that are not audio files.
- For more information on file extensions, see <Supported Audio Files> on the right.

- In this manual, MP3, WMA, AAC and WAV files are referred to collectively as "audio files".

Supported Audio Files

On this system, you can play the audio file types listed below (MP3, WMA, AAC and WAV).

MP3 files (CD/USB)

Extension: .mp3
Sampling frequency: 32/44.1/48 kHz
Bit rate: 32 k - 320 kbps

WMA files (CD/USB)

File format:
 Windows Media™ Audio 9 compliant
Extension: .wma
Sampling frequency: 32/44.1/48 kHz
Bit rate: 32 k - 320 kbps

- Files created using functions in Windows Media™ Player 9 or later cannot be played.
 - WMA Professional
 - WMA Lossless
 - WMA Voice

AAC files (CD/USB)

File format:
 MPEG-4 AAC (created in iTunes™ 4.1 to 10.4)
Extension: .m4a
Sampling frequency: 32/44.1/48 kHz
Bit rate: 32 k - 320 kbps

- Files encoded using Apple's Lossless Encoder cannot be played.

WAV files (USB only)

Extension: .wav
Sampling frequency:
 8/16/22.05/24/32/44.1/48 kHz
Quantization bit rate: 8/16-bit

CD file system

ISO 9660 Level 1, ISO 9660 Level 2, Joliet, Romeo

Number of file limits

Max. files/folders: 999 in total
Max. folders: 255

Maximum number of displayable characters

File names: 64 (including file extension)
Folder names: 64

Tag display:
 ID3 TAG
 Ver1.0, 1.1: 30
 Ver2.2, 2.3, 2.4: 64

- This system is capable of displaying alphanumeric characters. Other character types are displayed as asterisks (*).
- Tags for WAV files cannot be displayed on this system.

Continued to next page 

Supported Audio Files (continued)

Other notes

- Note that even where audio files comply with the above standards, playback may fail due to factors such as the disc characteristics or recording conditions.
- Playback also may fail depending on the specifications of the encoding software or the settings used for encoding.
- DRM (Digital Rights Management) files cannot be played.
- Audio files encoded using VBR (Variable Bit Rate) may use bit rates that fall outside the supported range. Audio files with bit rates outside the supported range cannot be played.

- Please back up audio files to be used in the system. Certain conditions while using a USB device can cause contents stored on the USB device to be lost. Please note that Kenwood will not be held liable for any losses arising out of loss of stored data.

- "Made for iPod" and "Made for iPhone" mean that an electronic accessory has been designed to connect specifically to iPod or iPhone, respectively, and has been certified by the developer to meet Apple performance standards. Apple is not responsible for the operation of this device or its compliance with safety and regulatory standards. Please note that the use of this accessory with iPod or iPhone may affect wireless performance.
- iPhone, iPod, iPod classic, iPod nano, and iPod touch are trademarks of Apple Inc., registered in the U.S. and other countries.
- Microsoft and Windows Media are either registered trademarks or trademarks of Microsoft Corporation in the United States and/or other countries.

Handling Discs

Handling precautions

Hold a CD taking care not to touch the played surface.

Discs playable on the system

This system can play back a CD, CD-ROM, CD-R, CD-RW or the audio part of a CD-EXTRA disc.

Notes on CD-ROM/CD-R/CD-RW discs

If the CD-ROM, CD-R or CD-RW disc being used has a printable label surface, the label surface may cause sticking that makes it impossible to remove the disc from the system. To prevent malfunction of the system, do not use such a disc.

Cautions on CD discs

Always use a disc carrying the  marking.

A disc without this marking may be unable to be played back correctly.

The disc rotates at a high speed during playback. Never use a cracked, chipped or greatly warped disc. Otherwise, damage or malfunction of the player may result.

Also, do not use a disc with a non-circular shape as this may result in malfunction.

Notes on transporting or moving the system

Before transporting or moving this unit, take the following actions:

- ① Remove any CDs from the unit.
- ② Press the [CD▶/II] key and check to make sure that the message "No Disc" appears on the display.
- ③ Wait a few seconds and then turn the system off.
- ④ If there are any other components connected to the system, check to make sure they are all turned off before disconnecting the cables.

Procedures by Input Source

This chapter explains the operation procedures for each input source.

This manual explains the operations assuming that you will use the remote control. Some buttons on the main unit are the same as those on the remote control. You can use either button in this case.

For information on the sound quality settings and component settings regardless of the input source, see "Audio Settings" (P.51) and "Component Settings" (P.59). If an error is displayed or a problem arises, see "Maintenance" (P.69).

CD

- Playing a CD 26
- Selecting Folder Playback Mode 29
- CD Random Playback Mode 29
- CD Repeat Playback Mode 29
- CD Program Playback Mode 30

iPod/iPhone

- Playing from an iPod/iPhone 32

USB

- Playing Back from a USB Device 34
- Program Playback Mode of Audio Files in the USB Device 36

Receiving Radio Broadcasts

- Listening to FM/AM Radio 38
- Presetting Stations Automatically (Auto Memory) 40
- Presetting Stations Manually (Manual Preset) 41

Radio Data System

- PS (Program Service) Name Display 42
- Searching for a Desired Program Type (PTY Search) 43

PC

- Connecting a PC and Playing Its Contents 44
- Adjusting the Volume Using a PC 45

External Components

- Playback from External Components 46
- Adjusting the External Component Input Level 47

D.AUDIO

- Playing from a Digital Audio Player 48
- Adjusting the Digital Audio Player Input Level 50





CD

This section explains how to play a CD. As well as normal playback, you can use folder playback, random playback, repeat playback and program playback.

Playing a CD

Insert and play the CD.

- If a disc is already inserted, simply press the **[CD▶/II]** key to turn the system on and begin playback.

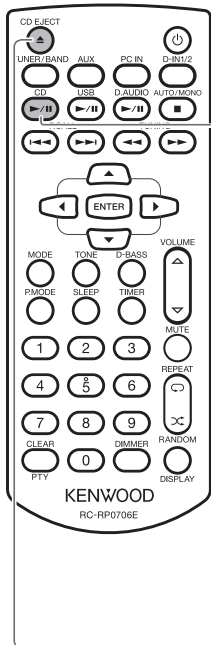

1 Insert the CD.

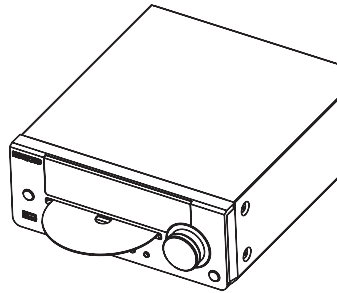

- Insert the disc with the label side facing upwards. The "Reading" message flashes while the unit is reading the information on the CD. When the installation of the disc is complete, "CD" lights up.

2 Press the **[CD▶/II]** key.



A CD is inserted

Track number during playback

Elapsed time of current track

■ To eject the CD

Stop playback and press the **[CD EJECT]** key on the remote control or the **[▲]** key on the main unit.



- Track numbers may not be displayed correctly when the following types of discs are played.
 - Discs recorded in multiple sessions

Related Information

● Audio Settings → P.51 onwards

■ Operations during CD playback



Pausing and resuming playback
Press the [CD ▶/||] key.

Stopping playback
Press the [■] key. For information on the Resume function, see below.

Skipping forward/back
Hold down the [◀◀] key or [▶▶] key.

Skipping tracks, skipping back, skipping to the start
To skip to the next track: Press the [▶▶▶] key.
To return to an earlier track: Press the [◀◀◀] key two or more times in succession.
To return to the beginning of a track: Press the [◀◀◀] key once.

Selecting the folder
CD-R/CD-RW discs containing MP3/WMA/AAC files
Press the [▲] or [▼] key.

Specifying a track number
To play the 3rd track, press the [3] key and then press the [ENTER] key.
To play the 17th track, press the [1], [7] keys and then press the [ENTER] key.
To play the 123rd track, press the [1], [2] and [3] keys.

Switching display contents
Press the [DISPLAY] key. The mode changes as shown below each time you press the key.

CD-R/CD-RW discs recorded in the commercially available music CD/CD-DA format
During Program playback/CD track playback/All-tracks repeat playback

```

    graph LR
      A[Elapsed time for the track number] --> B[Remaining time for the track number]
      B --> C[Total remaining time]
      C --> D[Total elapsed time]
      D --> E[Day/Clock]
      E --> A
    
```

During Random playback/single-track repeat playback

```

    graph LR
      A[Elapsed time for the track number] --> B[Remaining time for the track number]
      B --> C[Day/Clock]
      C --> A
    
```

CD-R/CD-RW discs containing MP3/WMA/AAC files

```

    graph LR
      A[Elapsed time for the track number] --> B[File name]
      B --> C[Folder name]
      C --> D[TAG]
      D --> E[Album name]
      E --> F[Artist name]
      F --> G[Title]
      G --> H[Day/Clock]
      H --> A
    
```

MP3/WMA/AAC

- When you stop playback by pressing the [■] key, the track being played is stored and pressing the [CD ▶/||] key restarts playback from the beginning of that track. (Resume function)
- The Resume function is cancelled if you switch to another input source during playback.

■ Playback sequence for folders and track files

MP3/WMA/AAC

When you play a disc containing recorded audio files, the track files on the disc are played sequentially beginning with the files in the ROOT folder, as shown in the figure.

Sample folder configuration

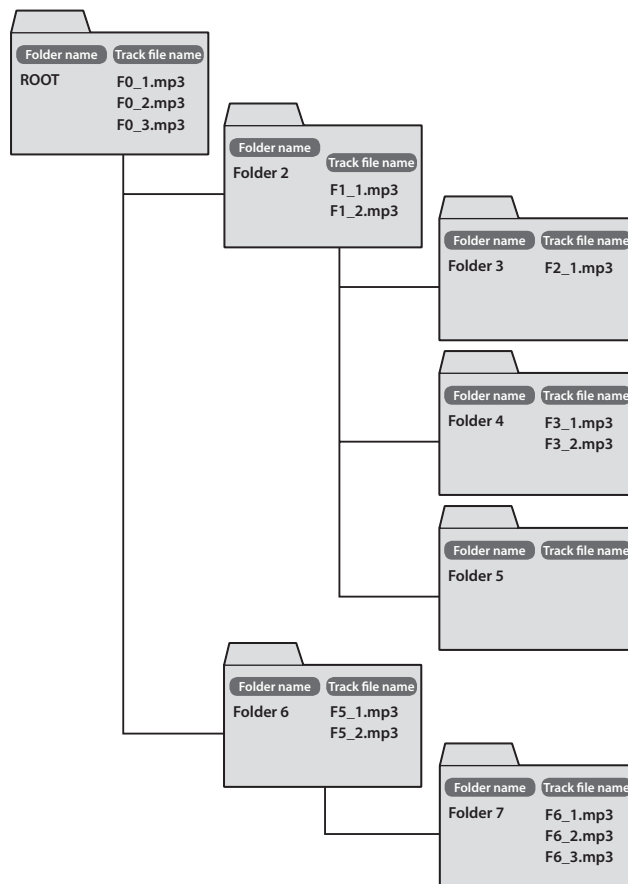

■ Track file playback sequence

Track 1.....F0_1.mp3
 Track 2.....F0_2.mp3
 Track 3.....F0_3.mp3
 Track 4.....F1_1.mp3
 Track 5.....F1_2.mp3
 Track 6.....F2_1.mp3
 Track 7.....F3_1.mp3
 Track 8.....F3_2.mp3
 Track 9.....F5_1.mp3
 Track 10.....F5_2.mp3
 Track 11.....F6_1.mp3
 Track 12.....F6_2.mp3
 Track 13.....F6_3.mp3



- A folder that does not contain any tracks cannot be selected.
- Audio files are played back in accordance with the sequence where these files are recorded into the CD. You can specify the playback sequence by adding a number from "01" to "99" at the beginning of each folder and file name before you record the files onto the disc. (A (ROOT) folder that does not contain any file will be counted as one folder.)

Related Information

- Supported Audio Files → P.23, 24
- Audio Settings → P.51 onwards

Selecting Folder Playback Mode

MP3/WMA/AAC

This mode plays only the files in the selected folder.

- If the CD is already playing, press the [■] key to stop playback.

1 Press the [P.MODE] key to select the folder playback mode.

- The mode changes as shown below each time you press the key.



2 Press the [▲] or [▼] key to select the folder to be played.

CD Random Playback Mode

This mode plays the tracks in the CD or in a folder in a random sequence.

- If the CD is already playing, press the [■] key to stop playback. When there are folders in the CD, select a folder you want to play back and then use the procedure below during playback.

1 Press the [RANDOM] key.

- The mode changes as shown below each time you press the key.

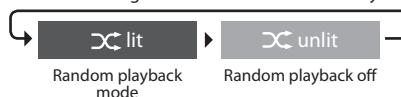

- Pressing the [I◀◀] key skips back to the beginning of the track being played.

CD Repeat Playback Mode

This mode plays the tracks on a CD repeatedly.

1 Press the [CD▶/II] key to play the tracks you want to repeat.

2 Press the [REPEAT] key to begin repeat playback.

- The mode changes as shown below each time you press the key.



- If you press the [REPEAT] key during program playback, "CD" and "PGM" light up on the display and repeat playback begins for all the programmed tracks.
- If you press the [REPEAT] key during random playback to activate all-tracks repeat playback, "CD" and "∞" light up on the display and random playback begins with a different sequence once the current random sequence ends.

CD

CD Program Playback Mode

You can select up to 30 tracks and play them in the order you like.

- Press the [CD▶/||] key to switch the input source to CD. Playback begins when you switch the input source, so press the [■] key to stop playback.
- If the CD is already playing, press the [■] key to stop playback.

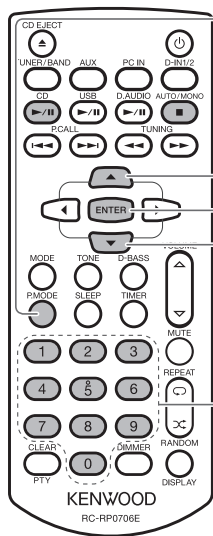

1 CD

Press the [P.MODE] key to select program playback mode.

The mode changes as shown below each time you press the key.

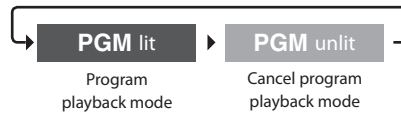

MP3/WMA/AAC

1 Press the [P.MODE] key to select program playback mode.

The mode changes as shown below each time you press the key.

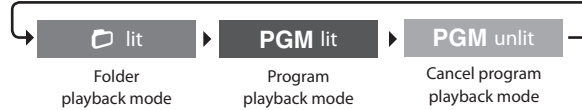

2 Press the [▲] or [▼] key to select the folder to be used for program playback.

■ You can also use number keys to select the folder.

To select folder number 3, press the [3] key and then press the [ENTER] key.
For folder number 17, press the [1], [7] keys and then press the [ENTER] key.
For folder number 123, press the [1], [2], and then the [3] key.

Related Information

• CD Repeat Playback Mode → P.29

CD

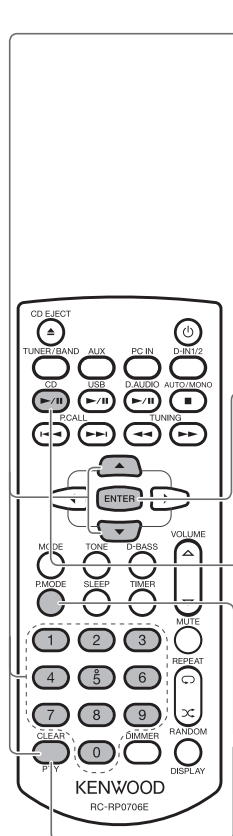

2 Press the [▲] or [▼] key to select the track or file you want to listen to.

CD	MP3/WMA/AAC
P01+T10	P01+F005 T058

When Track 10 is selected as program track 1. When folder number 5 and file number 58 are selected.

3 Press the [ENTER] key.

4 To select two or more tracks, repeat steps 2 and 3 ([CD]), or steps 1-2 to 3 ([MP3/WMA/AAC]).

5 Press the [CD▶/II] key to begin playback.



- You can also use number keys to select the file.
- If you enter the wrong information, press the [CLEAR] key before you proceed to step 3. Then enter the information again.
- Proceed to step 3 within 20 seconds after selecting a track or file.

- **To cancel program mode**
Stop playback and press the [P.MODE] key so that "PGM" is no longer displayed.
- **To remove a track from a program**
Stop playback and then press the [CLEAR] key. Each time you press the key, the last programmed track is cleared.
- **To add a track to the end of the program**
If you are already playing a CD, stop playback and carry out steps 2 and 3 ([CD]) or steps 1-2 to 3 ([MP3/WMA/AAC]).



- If you turn the system off, switch to another input source or remove the CD for which program playback is set, the information in the specified program is erased.



iPod/iPhone

This section explains how to connect and play from an iPod/iPhone.

Playing from an iPod/iPhone

Use this procedure to connect an iPod/iPhone to the system for playback.

- Also refer to the instruction manual that comes with the iPod/iPhone.
- Update the software for iPod/iPhone to the latest version.

Supported models of iPod/iPhone (As of October 2011)

- iPhone 4S
- iPhone 4
- iPhone 3GS
- iPhone 3G
- iPhone
- iPod touch 4th Generation
- iPod touch 3rd Generation
- iPod touch 2nd Generation
- iPod touch
- iPod nano 6th Generation
- iPod nano 5th Generation
- iPod nano 4th Generation
- iPod nano 3rd Generation
- iPod nano 2nd Generation
- iPod classic

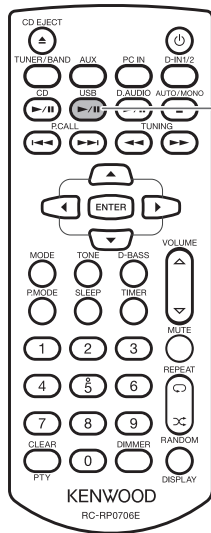

1 Connect an iPod/iPhone to the [USB] connector on the front panel of the main unit.

- The iPod/iPhone can be charged once it is connected when the main unit is turned on.
- If an input source other than "USB" is selected when the iPod/iPhone is connected, "USB" on the display lights up. When you switch the input source to "USB" and start playback, "iPod" will light up.

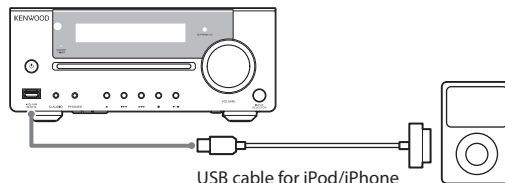

USB cable for iPod/iPhone
(Supplied with iPod/iPhone or commercially available)

2 Press the [USB] key to begin playback.

- Simply pressing the [USB] key turns on the system and begins playback.

Related Information

- Supported Audio Files → P.23, 24
- Audio Settings → P.51 onwards

Operations during iPod/iPhone playback

You can also perform these operations on the iPod/iPhone.

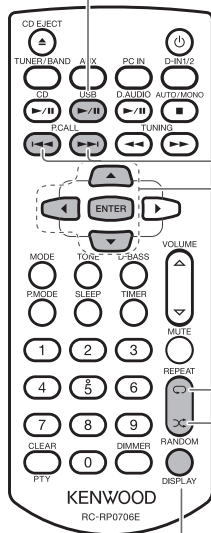

Pausing and resuming playback

Press the [USB▶/||] key. Press the [▶/||] key.

Skipping forward/back

Hold down the [I◀◀] or [▶▶I] key. Hold down the [I◀◀] or [▶▶I] key.

Skipping tracks, skipping back, skipping to the start

Skip a track

Press the [▶▶I] key. Press the [▶▶I] key.

Skip back to the previous track

Press the [I◀◀] key 2 or more times in succession. Press the [I◀◀] key 2 or more times in succession.

Return to the start of the track

Press the [I◀◀] key once. Press the [I◀◀] key once.

Select the iPod menu

Press the [◀] key to call up the iPod menu. Press the [▲] or [▼] key to select the desired menu. Press the [ENTER] key to determine the selection.

Setting the repeat playback

Press the [REPEAT] key. Each time you press the key, the repeat setting is changed.

Setting the random

Press the [RANDOM] key. Each time you press the key, the random setting is changed.

Switching display contents

Press the [DISPLAY] key to shift the selection.

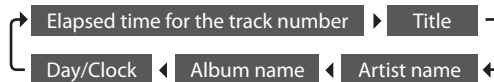



USB

This section explains how to connect a USB flash memory or USB mass storage class compliant digital audio player ("USB device") and play back audio files from it.

Playing Back from a USB Device

Connect a USB flash memory or USB mass storage class compliant digital audio player to the USB connector and play back audio files from it.

- Also refer to the instruction manual that comes with the USB device you are connecting.

Supported Files

WAV
MP3
WMA
AAC

See <Supported Audio Files> for details. (P.23, 24)

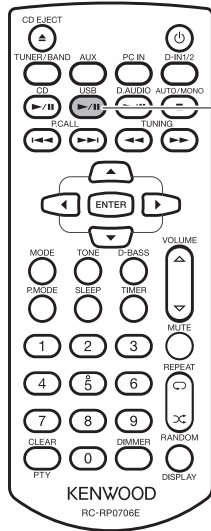

- 1 Connect a USB device to the [USB] connector on the front panel of the main unit.

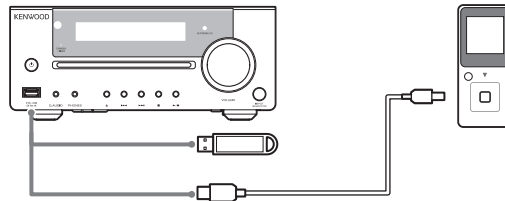

- 2 Press the [USB] key to begin playback.

- Simply pressing the [USB] key turns on the system and begins playback.
- After folders or files are searched, playback begins with the smallest file number. See P.28 for information on the playback sequence when there are multiple folders or files on the connected device.



- If no playable files are found, playback does not start.
- When playback resumes on a digital HDD audio player, sound may jump due to the mechanism specific to HDD.
- The Resume function is cancelled if you switch to another input source during playback.
- When you connect/disconnect a USB device, make sure the system is not performing any operation or that the power is turned off.

Related Information

- Supported Audio Files → P.23, 24
- Audio Settings → P.51 onwards

Operations during USB device playback

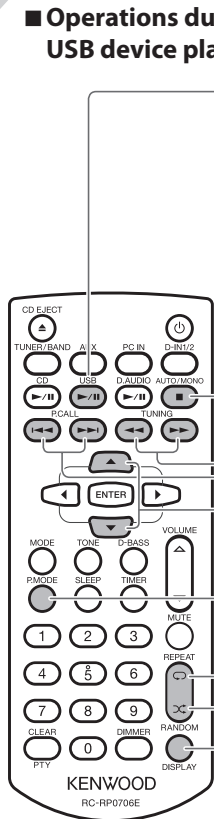

Pausing and resuming playback
 Press the **[USB▶/||]** key. Press the **[▶/||]** key.

Stopping playback
 Press the **[■]** key. Press the **[■]** key.

Skipping forward/back
 Press the **[◀◀]** or **[▶▶]** key. Press the **[◀◀]** or **[▶▶]** key.

Skipping tracks, skipping back, skipping to the start

Skip a track
 Press the **[▶▶]** key. Press the **[▶▶]** key.

Skip back to the previous track
 Press the **[◀◀]** key 2 or more times in succession. Press the **[◀◀]** key 2 or more times in succession.

Return to the start of the track
 Press the **[◀◀]** key once. Press the **[◀◀]** key once.

Selecting the folder
 Press the **[▲]** or **[▼]** key.

Selecting folder playback mode or program playback mode
 Press the **[P.MODE]** key to shift the selection.

lit lit unlit
 Folder playback mode Program playback mode Cancel program playback mode

Repeat playback mode
 Press the **[REPEAT]** key to shift the selection.

1 lit lit unlit
 Single-track repeat playback All-tracks/folders repeat playback Repeat playback off

Random playback mode
 Press the **[RANDOM]** key to shift the selection.

lit unlit
 Random playback mode Random playback off

Switching display contents
 Press the **[DISPLAY]** key to shift the selection.

Elapsed time for the track number File name Folder name
 Day/Clock TAG Album name Artist name Title

* Tags for WAV files cannot be displayed on this system.



Program Playback Mode of Audio Files in the USB Device

You can select up to 30 tracks and play them in the order you like.

- Press the **[USB▶/III]** key to switch the input source to USB. Playback begins when you switch the input source, so press the **[■]** key to stop playback.
- If the USB device is already playing, press the **[■]** key to stop playback.

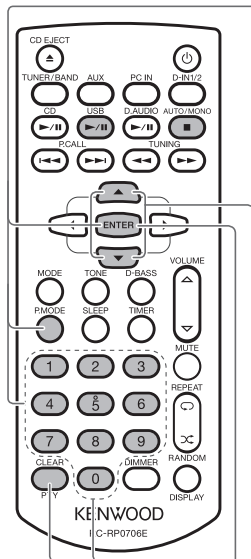

1 Press the [P.MODE] key to select program playback mode.

The mode changes as shown below each time you press the key.

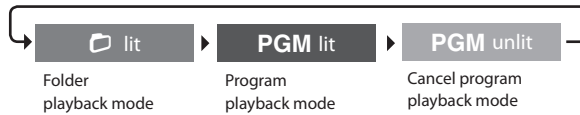

2 Press the [▲] or [▼] key to select the folder to be used for program playback.

- You can also use number keys to select the folder.

To select folder number 3, press the **[3]** key and then press **[ENTER]** key.
For folder number 17, press the **[1]**, **[7]** keys, and then press **[ENTER]** key.
For folder number 123, press the **[1]**, **[2]**, and then the **[3]** key.

2 Press the [▲] or [▼] key to select the track or file you want to listen to.



When folder number 5 and file number 58 are selected.

- You can also use number keys to select the file.
- If you enter the wrong information, press the **[CLEAR]** key before you proceed to step 3. Then enter the information again.
- Proceed to step 3 within 20 seconds after selecting a track or file.

3 Press the [ENTER] key.

USB

4 To select two or more tracks, repeat steps 1-2 to 3.

- You can select up to 30 tracks. If you attempt to select more tracks, the "Program Full" message is displayed.

5 Press the [USB▶/II] key to begin playback.

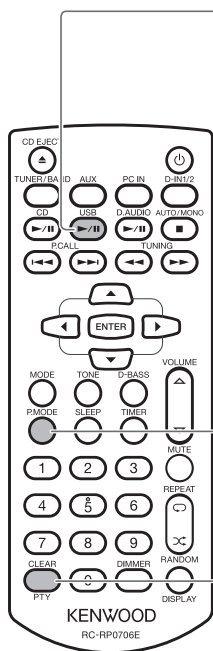

■ **To cancel program mode**

Stop playback and press the [P.MODE] key so that "PGM" is no longer displayed.

■ **To remove a track from a program**

Stop playback and then press the [CLEAR] key. Each time you press the key, the last programmed track is cleared.

■ **To add a track to the end of the program**

If you are already playing an audio file, stop playback and carry out steps 1-2 to 3.



- If you turn the system off, switch to another input source or remove the USB device for which program playback is set, the information in the specified program is erased.



Receiving Radio Broadcasts

This section explains how to listen to the FM/AM radio and memorize radio stations.

Listening to FM/AM Radio

- Simply pressing the [TUNER/BAND] key turns on the system and allows you to listen to the radio.

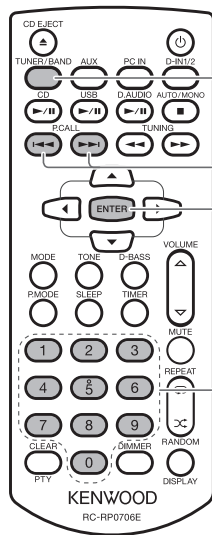

1 Press the [TUNER/BAND] key to select "FM" or "AM".

Each time you press the key, the band switches between "FM" and "AM".

2 Select a station.

Choosing from preset stations (Preset Call)

Select a preset station.

- See P.40 and P.41 for more information on presets.

■ Selecting with the [P.CALL] keys

To display the next stored station: Press the [I◀◀] or [▶▶I] key.

To run through the sequence of stored stations at intervals of roughly 0.5 seconds: Press and hold the [I◀◀] or [▶▶I] key.

■ Selecting with the number keys

To select P03, press the [0], and [3] keys.
To select P17, press the [1], and [7] keys.

▶ Press the [ENTER] key.

Receiving Radio Broadcasts

Related Information

- Presetting Stations Automatically (Auto Memory) → P.40
- Presetting Stations Manually (Manual Preset) → P.41
- Audio Settings → P.51 onwards

Choosing from stations that are not preset (Auto/ Manual Tuning)

1 Press the [AUTO/MONO] key to select Auto tuning or Manual tuning.

The mode changes as shown below each time you press the key.

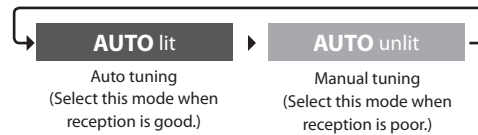

2 Press the [TUNING <=>/>=>] key to select a station.

When you operate on the main unit, press the [■] key and then press the [◀▶] or [▶▶] key.

When the station is tuned, "TUNED" lights up on the display. If you are receiving a stereo signal, "ST." also lights up.

■ Using Auto tuning

The radio automatically tunes in to the next station each time you press the key. Repeat this step until you are tuned in to your preferred station.

■ Using Manual tuning

Press the key until the desired station is tuned or until you reach the desired frequency.

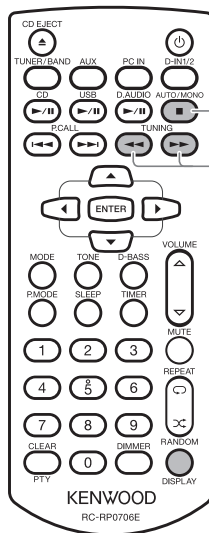

- There is no sound while Auto/Manual tuning is in progress.
- Auto tuning provides stereo reception while manual tuning provides monaural reception.
- The display changes as shown below each time you press the [DISPLAY] key.

FM:

Program service name → Preset No. → Day/Clock

When the program service name is not stored:

Preset No. → "No PS" → Day/Clock

AM:

Preset No. → Day/Clock

Receiving Radio Broadcasts

Presetting Stations Automatically (Auto Memory)

- Up to 40 stations can be preset in the system.
- For use of the Radio Data System function, stations must be memorized by Auto Memory.

1 Press the [MODE] key.

2 Select "Auto Memory".

Press the [◀] or [▶] key.

Auto Memory

Press the [ENTER] key.

- "Auto Memory" flashes on the display and the receivable radio stations are preset automatically.

- A preset frequency can be rewritten later.

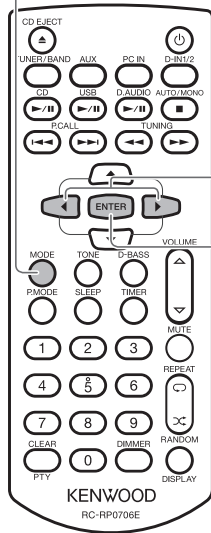

- Radio Data System stations are given priority during auto presetting. If there is memory left after presetting, this unit continues presetting regular FM and AM stations.
- A broadcast station that cannot be preset with Auto Memory should be set with Manual preset. (P.41)

Presetting Stations Manually (Manual Preset)

Use this procedure to make the station you are currently listening to a preset number. If the selected preset number is already assigned a station, the existing station is overwritten by the new station.

- You can preset up to 40 FM and AM stations.

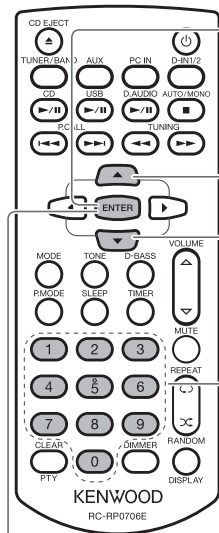

1 Tune in the station you want to preset, and then press the [ENTER] key.

Use Auto Tuning or Manual Tuning to tune in the desired station. (See P.39)



P--- FM 88.00 MHz

The preset number flashes.

2 Select the desired preset number (P01 to P40).

- Selecting with the [▲] or [▼] key.

- Selecting with the number keys

To select P03, press the [0], and [3] keys.
To select P17, press the [1], and [7] keys.

The currently selected preset number flashes.

P25 FM 88.00 MHz

- If the selected preset number is already assigned a station, the existing station is overwritten by the new station.

3 Press the [ENTER] key.

P25 FM 88.00 MHz

▼ 3 seconds later

Station1



Radio Data System

This system is designed for Radio Data System reception. It can extract the information from the broadcast signal for use with various functions such as automatic display of the station name.

- Select the FM band.
- Preset Radio Data System stations with the Auto Memory function. (P.40)

PS (Program Service) Name Display

When a Radio Data System broadcast is received, the station name is automatically displayed.

Station

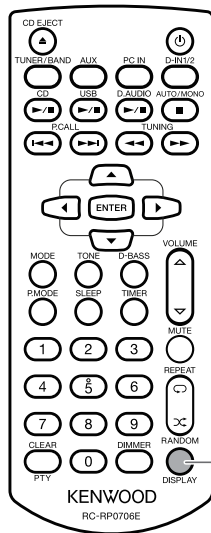

To switch the displays

Press the [DISPLAY] key.

- The mode changes as shown below each time you press the key.



- Some stations may not be provided or be given different names depending on countries or areas.

Searching for a Desired Program Type (PTY Search)

The tuner automatically searches for a station which is currently broadcasting a specified program type (genre).

1 Press the [PTY] key.



- When a Radio Data System broadcast is received, the program type is shown on the display. If no PTY data is available, or if the station is not a Radio Data System station, "None" is displayed.



2 Press the [▲] or [▼] key to select the desired program type.

- Select it while "PTY" is lit.
- Use the program type table for your convenience.

Program type table

Program Type Name	Display	Program Type Name	Display
Pop Music	Pop M	Weather	Weather
Rock Music	Rock M	Finance	Finance
Easy Listening Music	Easy M	Children's programs	Children
Light Classical Music	Light M	Social Affairs	Social
Serious Classical Music	Classics	Religion	Religion
Other Music	Other M	Phone In	Phone In
News	News	Travel	Travel
Current Affairs	Affairs	Leisure	Leisure
Information	Info	Jazz Music	Jazz
Sport	Sport	Country Music	Country
Education	Educate	National Music	Nation M
Drama	Drama	Oldies Music	Oldies
Culture	Culture	Folk Music	Folk M
Science	Science	Documentary	Document
Varied	Varied		

3 Press the [ENTER] key.

- No sound is heard while "PTY" is flashing.
- If a program of the desired type is found, that program is received and the program type name display changes to the station name display.

To cancel the PTY search
Press the [PTY] key.



- If a program of the desired type cannot be found, "No Program" flashes, then after several seconds the display returns to the original display.

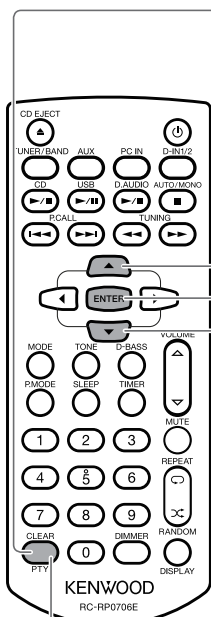



PC

On this system you can listen to the music stored in your PC.

Connecting a PC and Playing Its Contents

- Prepare a USB cable (Type A – Type B) for use in connection of the PC to this system (See P.12).

1 Connect the USB port of the PC to the [PC IN] terminal on the rear panel of the main unit using the USB cable.

- Turn this system off before connecting the PC to it.

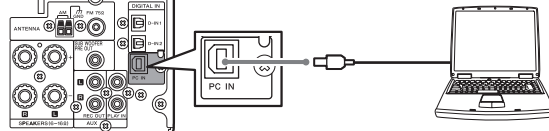

2 Turn the PC on.

3 Turn this system on.

- The driver software is installed automatically in the PC, which recognizes this system as "USB speaker".
- Do not disconnect the USB cable while the PC is detecting the connection of this system.
- If the PC does not recognize this system in a few seconds, try to:
 - Disconnect the USB cable and connect it again.
 - Reboot the PC

4 Press the [PC IN] key.

5 Control the PC software and open an audio file.

- The audio file should be selected on the PC. For the operations of the PC, refer to the manuals for your PC and the software.
- The volume can be controlled on this system.
- "PC" is displayed while the PC is connected.
- This system is compatible with 32 kHz/44.1 kHz/48 kHz sampling frequencies. It can receive 16-bit stereo/monaural data.
- The [PC IN] terminal of this system is used exclusively for input. It is not possible to record the audio played on this system into the PC.

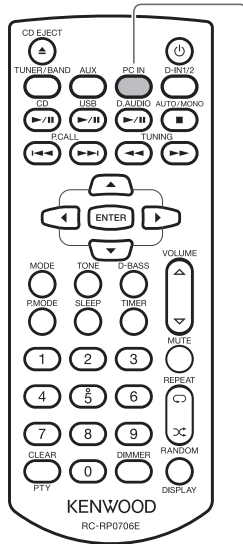

Related Information

- Connecting Other Accessories (Commercially Available Units) → P.12, 13
- Audio Settings → P.51 onwards

Adjusting the Volume Using a PC

- If the audio is not heard or is very low, check the Windows settings as described below.

Windows XP

Open the [Start] menu, select [Control Panel] and double-click on [Sound and Audio Devices Properties].



- Click on the [Audio] tab and select [USB Speakers].
- Click on [Volume] and adjust the volume. If the [Mute] checkbox is checked, uncheck it.

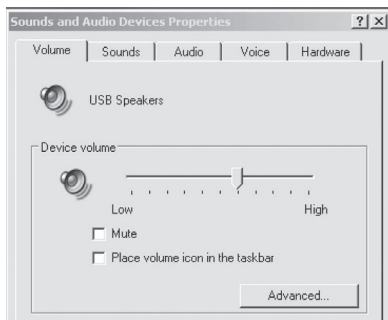

Windows Vista

Open the [Start] menu, select [Control Panel] and double-click on [Sound].

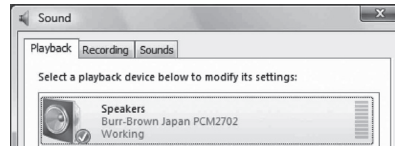

- From [Playback], select [Speakers].
- Click on [Levels] and adjust the volume.

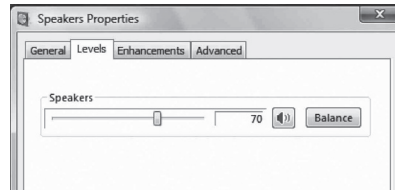

Windows 7

Open the [Start] menu, select [Control Panel] and click on [Hardware and Sound] and then click on [Sound].

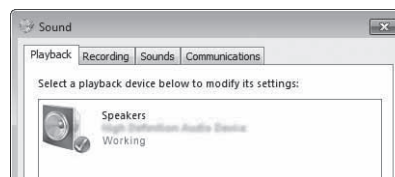

- From [Playback], select [Speakers].
- Click on [Levels] and adjust the volume.

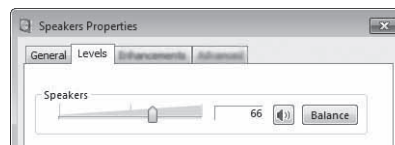



External Components

This section explains how to connect external components to the system and play back tracks.

Playback from External Components

Connect the external component to the system as described in <Connecting Other Accessories (Commercially Available Units)> (P.12, 13).

- When connecting external components, always turn this system and the external components off beforehand.
- Also refer to the instruction manual that comes with the external component being connected.

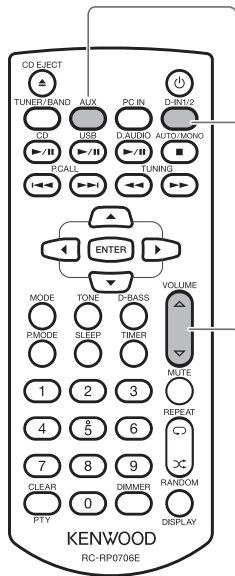

1 Press the [D-IN1/2] key to perform playback from a device connected to the [DIGITAL IN] terminal, while you press the [AUX] key to perform playback from a device connected to the [AUX PLAY IN] terminal.



- When a digital component is selected, the input signal sampling frequency is displayed.
- The system will play PCM (32, 44.1, 48, 88.2, 96 kHz) digital signals.

2 Begin playback on the connected external component.

Perform the required operation on the connected external component to start playback.

3 Adjust the volume level.

Related Information

- Connecting Other Accessories (Commercially Available Units) → P.12, 13
- Audio Settings → P.51 onwards

Adjusting the External Component Input Level

Use the procedure below to adjust the input level for the external component connected to the [AUX PLAY IN] terminal. Use this adjustment when the volume from an external component is noticeably higher or lower than other input sources at the same volume setting.

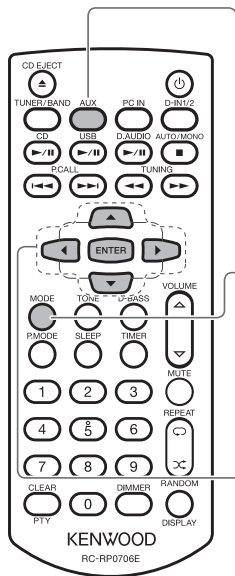

1 Press the [AUX] key.

2 Press the [MODE] key.

3 Select "Input Level".

Press the [◀] or [▶] key.

Input Level

Press the [ENTER] key.

4 Adjust the Input Level.

Press the [▲] or [▼] key.

Level 0

Press the [ENTER] key.

- You can adjust the input level in a range from -3 to 5.



- Signals input via the [AUX PLAY IN] terminal will not be output from the [AUX REC OUT] terminal.

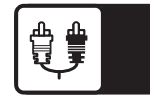



D.AUDIO

You can connect a Kenwood digital audio player (referred to hereafter simply as "digital audio player") to the system and use it to play tracks.

Playing from a Digital Audio Player

Use this procedure to connect a digital audio player to the system and play tracks.

- Always turn this system and the digital audio player off before connecting the digital audio player.
- Also refer to the instruction manual that comes with the digital audio player you are connecting.
- Connecting the digital audio player using the dedicated cable PNC-150 allows you to operate the digital audio player using the main unit or the remote control.

Compatible Kenwood digital audio players

HDD audio player	Memory audio player/recorder
HD20GA7	M1GC7, MGR-A7, MGR-E8

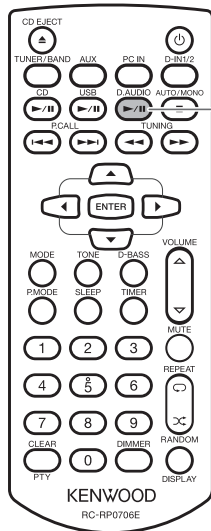

- 1 **Connect the digital audio player to the [D.AUDIO] terminal on the front panel of the main unit.**

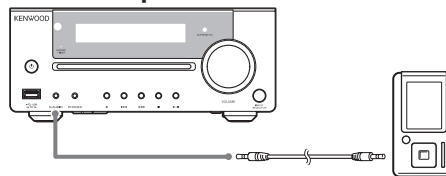

- 2 **Turn on the digital audio player.**

- 3 **Press the [D.AUDIO] / [II] key to begin playback.**

- Simply pressing the [D.AUDIO] / [II] key turns on the system and begins playback.
- If the digital audio player is not connected using the dedicated cable PNC-150, use the controls on the connected digital audio player.
- If playback does not start, select a desired artist, album or others on the digital audio player and then start playback.



- If you use the dedicated cable for the connection, the volume and sound quality settings on the digital audio player are disabled.
- When you have finished using the digital audio player, disconnect the player's connection cable from the [D.AUDIO] terminal.

Related Information

- Adjusting the Digital Audio Player Input Level → P.50
- Audio Settings → P.51 onwards

■ Operations during digital audio player playback

Pausing and resuming playback	
Press the [D.AUDIO▶/] key.	Press the [▶/] key.
Stopping playback	
Press the [■] key.	Press the [■] key.
Skipping forward/back	
Hold down the [I◀◀] or [▶▶I] key.	Hold down the [I◀◀] or [▶▶I] key.
Skipping tracks, skipping back, skipping to the start	
Skip a track	
Press the [▶▶I] key.	Press the [▶▶I] key.
Skip back to the previous track	
Press the [I◀◀] key two or more times in succession.	Press the [I◀◀] key two or more times in succession.
Return to the start of the track	
Press the [I◀◀] key once.	Press the [I◀◀] key once.
Selecting the folder	
Press the [▲] or [▼] key.	
Switching display contents	
Press the [DISPLAY] key to shift the selection.	



- Skipping a folder is not possible if the playback is from a selection of tracks on the digital audio player.
- Some functions may not work depending on the connected component.

D.AUDIO

Adjusting the Digital Audio Player Input Level

Use the procedure below to adjust the input level for the external component connected to the [D.AUDIO] terminal.

Use this adjustment when the volume from an external component is noticeably higher or lower than other input sources at the same volume setting.

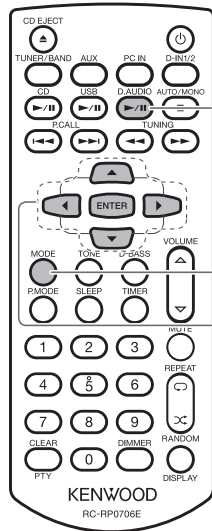

1 Press the [D.AUDIO▶/II] key.

2 Press the [MODE] key.

3 Select "Input Level".

Press the [◀] or [▶] key.

Input Level

Press the [ENTER] key.

4 Adjust the Input Level.

Press the [▲] or [▼] key.

Level

Press the [ENTER] key.

- You can adjust the input level in a range from -3 to 5.



- If you adjust the input level for D.AUDIO, the output level from the [AUX REC OUT] terminal will also change.

Audio Settings

Use the procedures in this chapter to specify the sound quality settings for your stereo system. You can use the system's sound quality function to customize the sound to your own preferences.

Digital Signal Processor

- Adjusting Super-Bass Tones (D-BASS)..... 52
- Adjusting the Range Levels (TONE) 53

Supreme EX

- Setting Supreme EX..... 56

Balance

- Adjusting the Speaker Volume Balance 57

Rec Out Level

- Adjusting the Recording Output Level 58



Digital Signal Processor

The system has a digital signal processor (DSP), which allows you to adjust the impact of super-bass tones and the levels of low-, mid-, and high-range tones.

This provides more detailed settings that allow you to adjust the sound to your own preferences.

Adjusting Super-Bass Tones (D-BASS)

This feature lets you tailor the impact of super-bass tones to your own preferences.

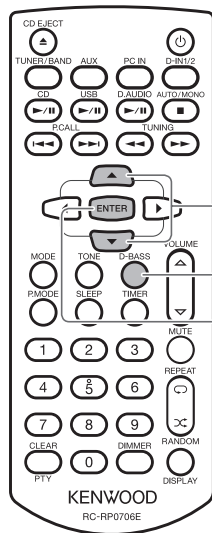

1 Press the [D-BASS] key.

2 Press the [▲] or [▼] key to adjust the level.

D-BASS 4

- While the "D-BASS" is flashing on the display, you can adjust the level in a range from 0 (Off) to 10. Higher numbers give more pronounced super-bass tones.

- The "D-BASS" flashes while setting is in progress.

3 Press the [ENTER] key.

- If you set level 1 or higher, the "D-BASS" lights.

Adjusting the Range Levels (TONE)

You can adjust the low-, mid- and high-range tones to match your preferences (TONE).

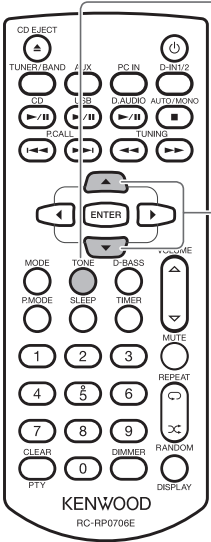

1 Press the [TONE] key, and then select [Bass] from the range levels (Bass: low-range tones, Mid: mid-range tones, Treble: high-range tones).

2 Press the [▲] or [▼] key to adjust the low tones (Bass) level.



- The "TONE" flashes while setting is in progress. While the "TONE" is flashing, you can adjust the level in a range from -8 to +8.



Continued to next page

Digital Signal Processor

3 Press the [TONE] key, and then select [Mid].

4 Press the [▲] or [▼] key to adjust the mid tones (Mid) level.

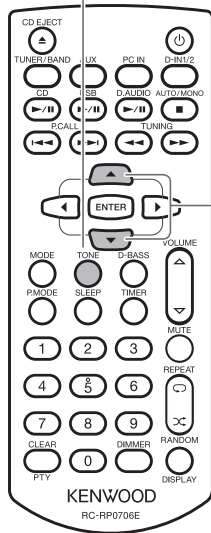

- The "TONE" flashes while setting is in progress. While the "TONE" is flashing, you can adjust the level in a range from -8 to +8.



Digital Signal Processor

5 Press the [TONE] key, and then select [Treble].

6 Press the [▲] or [▼] key to adjust the high tones (Treble) level.

7 Press the [ENTER] key.

- The "TONE" flashes while setting is in progress. While the "TONE" is flashing, you can adjust the level in a range from -8 to +8.
- If you set a level other than 0, the "TONE" is displayed.
- If you do not need to adjust all the range levels, press the [ENTER] key to end the settings after you have finished the range level adjustments you want to make.

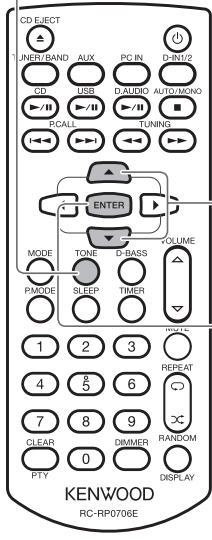

Supreme EX

Supreme EX is Kenwood's original sound quality enhancement technology and is used for playing CDs and audio files or for playback using components connected to a digital input terminal.

Setting Supreme EX

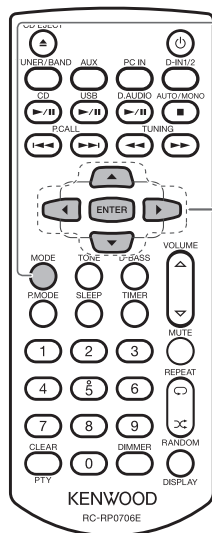

1 Press the [MODE] key.

2 Select "SPRM Set".

Press the [◀] or [▶] key.

SPRM Set

- The "SPRM Set" flashes while setting is in progress.

Press the [ENTER] key.

3 Select "On" or "Off".

Press the [▲] or [▼] key.

SPRM On

SPRM Off

- "SPRM EX" lights when "SPRM On" is selected, while it turns off when "SPRM Off" is selected.

Press the [ENTER] key.



- The Supreme EX function operates when "CD", "D-IN1", "D-IN2", "USB" or "PC IN" (44.1 kHz, 48 kHz) is selected.
- The [SUPREME EX] indicator will light up while the Supreme EX function is activated.
- When "D-IN1" or "D-IN2" is selected, the "SPRM EX" does not light if the input signal frequency is 96 kHz or 88.2 kHz.

Balance

Use this procedure to adjust the volume balance for the left and right speakers.

Adjusting the Speaker Volume Balance

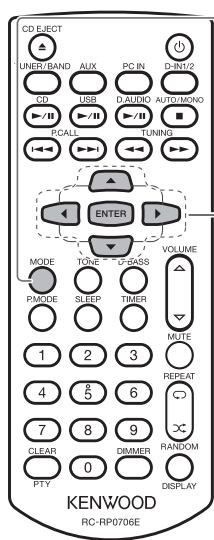

1 Press the [MODE] key.

2 Select "Balance".
Press the [◀] or [▶] key.

Balance

▼

Press the [ENTER] key.

3 Adjust the balance.
Press the [▲] or [▼] key.

Balance

▼

Press the [ENTER] key.



Rec Out Level

If the audio recorded on the component connected to the [AUX REC OUT] terminal is distorted or too low, adjust the recording output level.

Adjusting the Recording Output Level

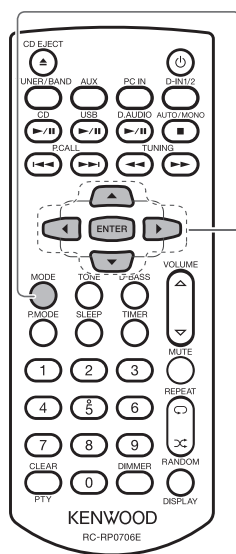

1 Select the input source to be output at the recording output.

2 Press the [MODE] key.

3 Select "Rec Out Level".

Press the [◀] or [▶] key.

Rec Out Level

Press the [ENTER] key.

4 Adjust the recording output level.

Press the [▲] or [▼] key.

Level +2

Press the [ENTER] key.

- You can adjust the level in a range from -5 to +3.

Component Settings

This chapter explains basic timekeeping settings, as well as settings for the timer, display, and other functions which provide more extensive usage of this product.

Setting the System Clock.....60

Setting the Timer

- Setting the Sleep Timer (SLEEP) 61
- Setting the Program Timer (Timer Set) 62

Display Settings

- Setting the Display Brightness (DIMMER) 67
- Turning the Display Saver ON/OFF 67





Auto Power Save (A.P.S.)68

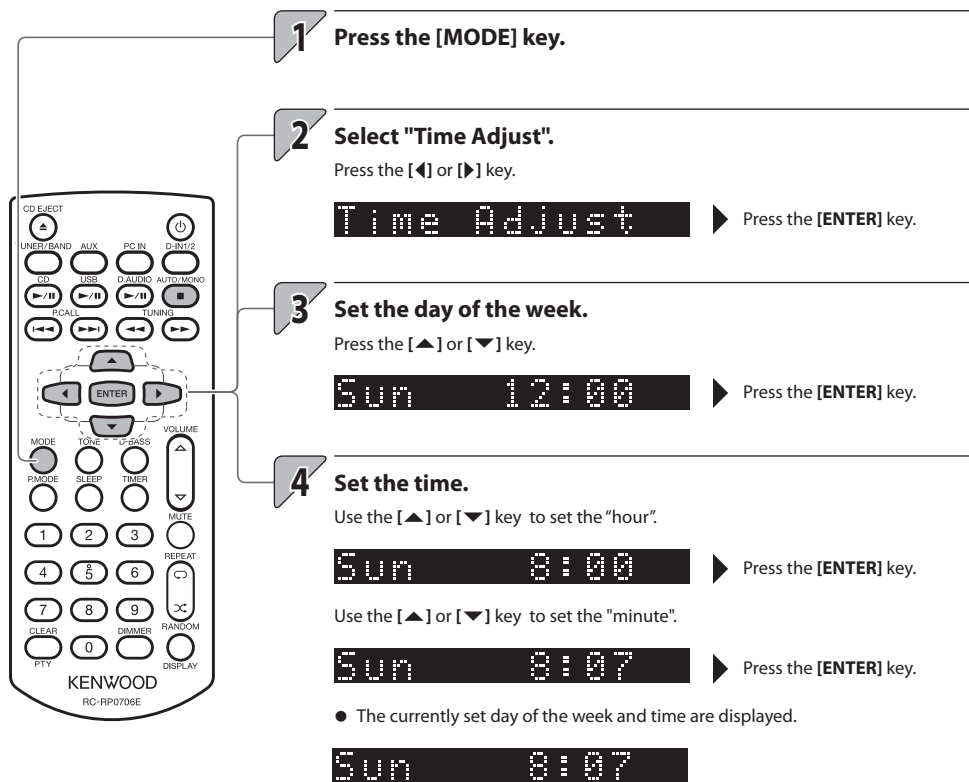

Setting the System Clock

Set the system clock to the correct time and the day of the week.



- 1 Press the [MODE] key.**
- 2 Select "Time Adjust".**
Press the [◀] or [▶] key.
 ▶ Press the [ENTER] key.
- 3 Set the day of the week.**
Press the [▲] or [▼] key.
 ▶ Press the [ENTER] key.
- 4 Set the time.**
Use the [▲] or [▼] key to set the "hour".
 ▶ Press the [ENTER] key.
Use the [▲] or [▼] key to set the "minute".
 ▶ Press the [ENTER] key.
 - The currently set day of the week and time are displayed.



- If you make a mistake, repeat the procedure from the beginning.
- When you want to return to the previous step during the setting procedure, press the [◀] key.
- If there is a power failure or the system is unplugged from the wall outlet for some time, set the time again.
- Pressing the [■] key on the remote control or on the main unit while the system is in the Standby mode will display the time for 5 seconds.
- If the system clock time setting is not correct, the Program Timer will not start playback at the correct time.
- As a certain margin of error is allowed for the clock, it is recommended that you check and adjust the clock at regular intervals.

Setting the Timer

A Sleep Timer automatically turns the system off after a set interval, while a Program Timer starts playback at a specified time.

Setting the Sleep Timer (SLEEP)

This function automatically turns the system off after a set interval. You can set an interval from 10 to 120 minutes.

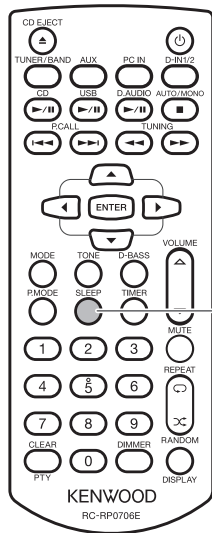

1 Press the [SLEEP] key.

Each time you press the key, the interval changes as follows. The next setting after 120 minutes is timer off.



Sleep Timer on



- While the Sleep Timer is running, you can check the remaining time by pressing the [SLEEP] key.

■ To cancel the Sleep Timer

Press the power [⏻] key to turn the system off (Standby) or press the [SLEEP] to turn off "☺".



Continued to next page

Setting the Timer

Setting the Program Timer (Timer Set)

This function allows you to use the timer to start playback automatically at a specified time. You can set two timers ("Program 1" and "Program 2") at the same time. You can play back from a radio, CD, iPod/iPhone, USB device, or external component (AUX PLAY IN, DIGITAL IN).

- Set the system clock to the correct time before performing this procedure. (See P.60)
- Make sure the times for "Program 1" and "Program 2" are different by at least 1 minute to ensure that their operations do not overlap.
- When you want to return to the previous step during the setting procedure, press the [◀] key.

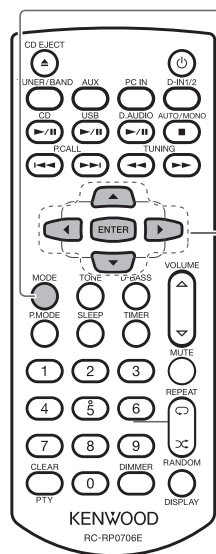

1 Press the [MODE] key.

2 Select "Timer Set".

Press the [◀] or [▶] key.

Timer Set

Press the [ENTER] key.

3 Select "Program 1 Set" or "Program 2 Set".

Press the [▲] or [▼] key.

Program 1 Set

Press the [ENTER] key.

Related Information

● Setting the System Clock → P.60

4 Select "On" or "Off".

Press the [▲] or [▼] key.



● Selecting "Off" ends the procedure and restores the original display.

Press the [ENTER] key.

5 Select the day (or days) on which the Program Timer will run.

Press the [▲] or [▼] key.

The mode changes as shown below each time you press the key.



Press the [ENTER] key.

● If you selected "Everyday", "Mon-Fri", "Tue-Sat" or "Sat-Sun", proceed to step 7.

6 Select "Every Week" or "Onetime".

Press the [▲] or [▼] key.



● The timer runs every week.

● The specified timer runs once only.

Press the [ENTER] key.

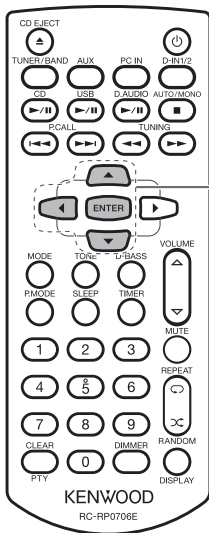

Continued to next page

Setting the Timer

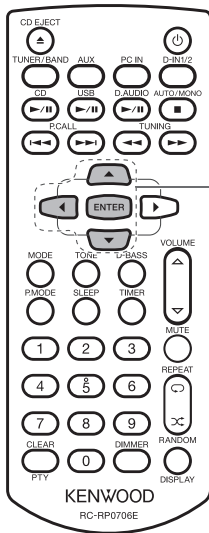

7 Specify the "On" (start time) setting.

Use the [▲] or [▼] key to set the "hour".

On 9:00

- The "hour" flashes.

▶ Press the [ENTER] key.

Use the [▲] or [▼] key to set the "minute".

On 9:15

- The "minute" flashes.

▶ Press the [ENTER] key.

8 Specify the "Off" (end time) setting.

Use the [▲] or [▼] key to set the "hour".

Off 11:00

- The "hour" flashes.

▶ Press the [ENTER] key.

Use the [▲] or [▼] key to set the "minute".

Off 11:03

- The "minute" flashes.

▶ Press the [ENTER] key.

Setting the Timer

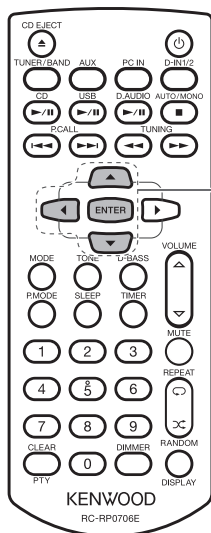

9 Select "Play" or "AI Play".

Press the [\blacktriangle] or [\blacktriangledown] key.

Play

- Playback is at the volume set in step 10.

AI Play

- Playback begins at the specified time and the volume gradually increases to the level set in step 10.

Press the [ENTER] key.

10 Set the volume.

Press the [\blacktriangle] or [\blacktriangledown] key.

Volume 39

- ▶ Press the [ENTER] key.

- You cannot use the [VOLUME] key to set the volume.

11 Select the input source.

Press the [\blacktriangle] or [\blacktriangledown] key.

The mode changes as shown below each time you press the key.



Press the [ENTER] key.

- If you select an input source other than "TUNER", this completes the settings and "Complete" is displayed briefly, after which the original display reappears.
- If you select "TUNER", use the [\blacktriangle] or [\blacktriangledown] to select a preset number and then press the [ENTER] key. This completes the settings and "Complete" is displayed briefly, after which the original display reappears.



Continued to next page

Setting the Timer

12 Press the power [⏻] key to turn the power off.

- The [STANDBY/TIMER] indicator on the main unit lights orange.
- If the indicator lights red, set the clock to the correct time.

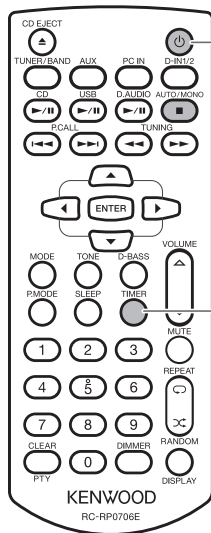

■ To turn a timer off or on

- When the system is turned on, press the [TIMER] key.

The setting changes each time you press the [TIMER] key.

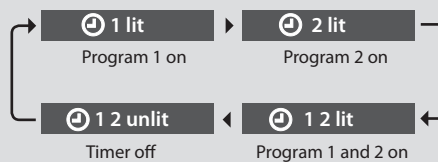

- The [STANDBY/TIMER] indicator will flash orange if there was a power failure or the system was unplugged from the wall outlet for some time. If this happens, set the system clock to the correct time again. (See P.60)



- To modify the program settings, reconfigure the timer settings from the beginning.
- When the system is in Standby mode, you can confirm the timer setting (on or off) for 5 seconds by pressing the [■] key.

Display Settings

Use these settings to adjust the brightness of the display.

Setting the Display Brightness (DIMMER)

Use this procedure to adjust the display brightness. Adjust the brightness according to your preferences and the conditions in the room.

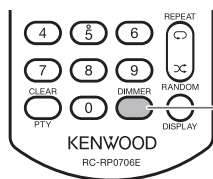

1 Press the [DIMMER] key.

- Each time you press the key, the display changes its brightness.

Turning the Display Saver ON/OFF

If the system is not used at all for a set period, this function scrolls the display to prevent burn-in of the text on the display and uneven display brightness.

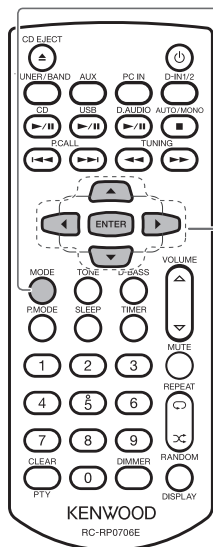

1 Press the [MODE] key.

2 Select "Display Saver".

Press the [◀] or [▶] key.

Display Saver

Press the [ENTER] key.

3 Select "On" or "Off".

Press the [▲] or [▼] key.

D. Saver On

D. Saver Off

Press the [ENTER] key.

- The display saver is active.
- The display saver is disabled.



- When you are playing from a CD or USB, the display saver is activated if the system is not used at all for 10 minutes after the playback stops. If you selected another input source, the display saver is activated if the system is not used at all for 10 minutes after the last key is pressed.

Auto Power Save (A.P.S.)

Auto Power Save (A.P.S.) automatically turns the system off if no operation is performed for 30 minutes after a CD or a USB connected device stops playing.

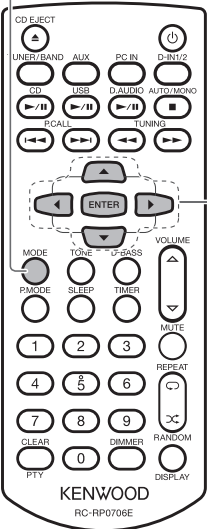

1 Press the [MODE] key.

2 Select "A.P.S. Set".
Press the [◀] or [▶] key.

A.P.S. Set ● "A.P.S." flashes on the display.

Press the [ENTER] key.

3 Select "On" or "Off".
Press the [▲] or [▼] key.

A.P.S. On ● "A.P.S." lights up on the display.

A.P.S. Off ● "A.P.S." turns off.

Press the [ENTER] key.



- If the input source is "TUNER", "D.AUDIO", "D-IN1", "D-IN2", "AUX", "iPod" or "PC IN", Auto Power Save operates when the volume is set to 0 (VOLUME 0) or MUTE is set to on. When recording on external components, turn A.P.S. off or adjust volume to above 1.

Maintenance

This chapter explains what to do when error messages appear on the display or when problems arise. It also describes how to store and maintain the system so it continues to give pleasure for many years to come.

Messages	70
Glossary of Terms	70
Troubleshooting	71
Care and Storage	74
Specifications	75



Messages

Displayed Message	Meaning
No Disc	There is no CD inserted. →Insert a CD.
No Program	No tracks are programmed. →Program the tracks you want to listen to. (See P.30, 36) →Cancel program mode and use normal playback. (See P.31, 37)
Program Full	An attempt was made to program a 31st track. →You can program only up to 30 tracks. (See P.31, 37)
Not Support	An iPod/iPhone that is not supported with this device is connected. (See P.32)
Non-PCM	The [DIGITAL IN] terminal on the rear panel of the main unit is receiving non-PCM input signals. (See P.13)
Unlock	The component connected to the [DIGITAL IN] or [PC IN] terminal on the rear panel of the main unit is not turned on. Alternatively, there is no signal input.
--- kHz	The sampling frequency of the input PCM signals is outside the playable range.
.....	There is no TAG information. (See P.23)

Glossary of Terms

Term	Meaning	Page
AAC	An abbreviation for "Advanced Audio Coding". This is a compression standard that applies only to the audio component in image compression methods used for digital broadcasting, etc.	23
Bit rate	A value indicating the amount of information processed per second. The higher the bit rate, the better the sound quality.	23
CD-DA	Refers to music CDs. Almost all discs normally referred to as "CDs" are actually CD-DA discs.	22
MP3	An audio compression method developed by Germany's Fraunhofer IIS, which achieves high rates of data compression by discarding data not readily audible to humans. MP3 can compress data down to rates of approximately 1/11 (128 kbps) while retaining sound quality equivalent to a music CD.	23
Sampling frequency	A value that indicates the number of times per second analog signals are sampled for conversion to digital signals. The sampling frequency for music CDs is 44.1 kHz. Normally, the higher the sampling frequency, the better the sound quality.	23
TAG information	Information included in audio files, such as title, artist, album, and genre.	23
USB	A standard for the interface to connect peripheral devices to a computer. This system supports USB 1.1 and 2.0.	22
USB mass storage class	A standard for computer control of a USB device. It also makes it possible for a computer to recognize a connected USB device as an external storage device.	22
WMA	An abbreviation for the "Windows Media™ Audio" audio compression and encoding system developed by Microsoft Corporation of the U.S.	23

Troubleshooting

Whenever the system is not operating as expected, check the following tables to see if you can resolve the problem yourself before requesting service.

Amplifier/ Speakers

Symptoms	Solution	Ref. page
No sound output	<ul style="list-style-type: none"> ● Check all connections as described in <Connecting the System>. ● Increase the volume. ● Cancel the MUTE setting. ● Unplug any headphones plugged into the main unit. 	10-13 20 20 13
[STANDBY/TIMER] indicator is flashing red and there is no sound.	<ul style="list-style-type: none"> ● One of the speaker cords is short-circuited. Unplug the power cord and then reconnect the speaker cord. ● There may be an internal problem. Turn off the power to the main unit, unplug the power cord and request repairs. 	—
No sound from the headphones	<ul style="list-style-type: none"> ● Check that the headphone plug is inserted correctly. ● Increase the volume. ● Cancel the MUTE setting. 	13 20 20
There is no sound from "D-IN1" or "D-IN2".	<ul style="list-style-type: none"> ● Check all connections as described in <Connecting the System>. ● Check whether "PCM" is selected for the digital audio output setting on the connected component. 	13
No sound from one of the speakers	<ul style="list-style-type: none"> ● Check all connections as described in <Connecting the System>. ● Check the volume balance for the left and right speakers. 	10 57
The clock display is flashing.	<ul style="list-style-type: none"> ● Set the clock as described in <Setting the System Clock>. 	60
The timer does not work.	<ul style="list-style-type: none"> ● Set the clock as described in <Setting the System Clock>. ● Set a start time and end time for the program timer. 	60 62

Tuner

Symptoms	Solution	Ref. page
No radio reception	<ul style="list-style-type: none"> ● Connect the antennas. ● Select the broadcast band (AM or FM). ● Tune the radio to the frequency of the desired station. 	10 38 38
Interference (noise)	<ul style="list-style-type: none"> ● Install an outdoor antenna away from roads. ● Turn off any electrical appliances that may be causing interference. ● Move the system away from the TV. 	—
Preset stations cannot be called	<ul style="list-style-type: none"> ● Preset radio stations with Auto Memory again. ● Manually preset stations with frequencies that you can receive. 	40 41



Troubleshooting

CD

Symptoms	Solution	Ref. page
A CD does not play back when loaded.	<ul style="list-style-type: none"> ● Load the disc correctly with the label side facing upwards. ● Clean the disc. (See <Care and Storage>.) ● Allow any condensation to evaporate. (See <Be careful against condensation>.) 	26 74 74
No sound output	<ul style="list-style-type: none"> ● Press the [CD▶/II] key. ● Clean the disc. (See <Care and Storage>.) 	26 74
Playback skips.	<ul style="list-style-type: none"> ● Clean the disc. (See <Care and Storage>.) 	74
Some audio files can't play back.	<ul style="list-style-type: none"> ● The system will not play audio files that are corrupted. ● Make sure the audio file is supported for playback on the system. 	23, 24
Delay until playback starts.	<ul style="list-style-type: none"> ● There may be a delay prior to playback if there are large numbers of folders. 	28
TAG information is not displayed correctly.	<ul style="list-style-type: none"> ● Refer to <Supported Audio Files> to check which TAG information can be displayed on this system. 	23, 24

USB

Symptoms	Solution	Ref. page
No sound output when a USB flash memory or USB audio player is connected.	<ul style="list-style-type: none"> ● Plug in the USB flash memory correctly. ● Connect the USB cable correctly. ● Check to make sure the USB audio player is turned on. 	12 34
The iPod/iPhone does not provide sound.	<ul style="list-style-type: none"> ● The iPod/iPhone is not properly connected. Remove the iPod/iPhone from the system, and then connect it again. 	32
The iPod/iPhone cannot be charged.	<ul style="list-style-type: none"> ● The iPod/iPhone is not properly connected. Remove the iPod/iPhone from the system, and then connect it again. 	32

Components connected to the D.AUDIO terminal

Symptoms	Solution	Ref. page
The main unit and remote control cannot control a Kenwood digital audio player.	<ul style="list-style-type: none"> ● Connect the player using the dedicated cable PNC-150. ● Check whether the connected model is compatible. 	13 48



Remote control

Symptoms	Solution	Ref. page
The remote control does not work.	<ul style="list-style-type: none"> ● Load new batteries. ● Use the remote control within its effective range. 	17 17

PC

Symptoms	Solution	Ref. page
The PC does not recognize this system.	<ul style="list-style-type: none"> Connect the PC and this system properly using a USB cable. If a USB hub is used in the connection, check if the hub is functioning properly. Alternatively, change the connected port. 	12
No audio output or too low level.	<ul style="list-style-type: none"> Set the PC properly. 	45
Audio is interrupted.	<ul style="list-style-type: none"> The audio may be interrupted if the PC is used for an operation that imposes a burden on the CPU during the audio output. Avoid executing operations that may impose a burden on the CPU. The audio may be interrupted if a USB cable is connected to or disconnected from another USB connector of the PC. Do not connect or disconnect the USB cables to other equipment during audio playback. 	—
Audio is noisy.	<ul style="list-style-type: none"> Noise may be noticeable if the system is installed near a source of strong magnetic waves (TV, etc.). Install the system away from a source of strong magnetic waves. 	9

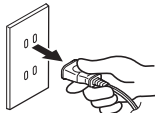
Resetting the microcomputer

Symptoms	Solution
Microcomputer malfunction (the system does not work, the display is faulty, etc.).	<ul style="list-style-type: none"> Malfunctions may occur due to an external cause or because a connection cord was unplugged while the system was turned on. Use the procedure below to reset the microcomputer. <ol style="list-style-type: none"> Unplug the power cord from the AC wall outlet.  Plug the power cord back in while holding down the power [⏻] key on the main unit.  Upon the start of the microcomputer resetting, the display shown on the right appears.  When finish resetting, it turns to Standby Mode. <ul style="list-style-type: none"> Bear in mind that resetting erases any stored information and restores the system's default settings.



Care and Storage

Care and storage of main unit

■ Keep the system out of the following locations

- Areas exposed to direct sunlight.
- Areas subjected to excessive humidity or dust.
- Areas exposed to direct heat from heating equipment.

■ Be careful against condensation

Extreme differences between system temperature and air temperature can cause water droplets (condensation) to form on the system. The system will not operate properly while condensation is present. If condensation forms, do not use the system for a few hours to allow the condensation to dry.

Take special care against condensation when the system is moved between two locations of very different temperatures, or into a room where high humidity is present.

■ When the main unit becomes dirty

When the front panel or case gets dirty, wipe it with a soft dry cloth. Never use lacquer thinner, benzene, alcohol or contact revitalizer, which will cause discoloration or deformation.

Care and storage of CDs

■ Storing a CD

If you do not plan to use a CD for a long time, remove it from the main unit and store it in its case.

■ Cleaning a CD

- When a disc is contaminated with fingerprints or other stains, wipe it gently in the radial direction using a soft dry cloth.
- Do not use a phonograph record cleaner, lacquer thinner, benzene or alcohol to clean CDs.
- Do not use any disc accessory (stabilizer, protective sheet, protective ring, etc.) or lens cleaner.

■ Other cautions

- Do not write on a CD with a pencil or ballpoint pen.
- Do not use a CD if its sticker or label is peeling or if any adhesive is coming out from under the sticker or label.
- Do not affix paper, stickers or labels to CDs.

Specifications

Main unit

[Amplifier]

Effective output power during STEREO operation..... 50 W+50 W
RMS (1kHz, 10%T.H.D., 6 Ω)

Tone control characteristics

BASS.....±8 dB (at 100 Hz)
MID.....±8 dB (at 1 kHz)
TREBLE.....±8 dB (at 10 kHz)
D-Bass (+10).....+10 dB (55 Hz, Vol. 60)

Input terminals (Sensitivity/Impedance)

LINE (AUX)..... 300 mV / 47 kΩ
LINE (D.AUDIO)..... 300 mV / 47 kΩ

Output terminals (Level/Impedance)

SUB WOOFER PRE OUT..... 2 V / 1 kΩ
LINE (AUX)..... 2 V / 1 kΩ

[Digital unit]

Sampling frequencies..... 32 kHz, 44.1 kHz, 48 kHz, 88.2 kHz, 96 kHz
Supreme EX (CD, D-IN, USB, PC IN)

Playable frequencies..... 1 Hz - 48 kHz
Digital input terminals (Sensitivity/Wave length)
Optical..... -15 dBm - -24 dBm, 660 nm ±30 nm

[USB]

Usable USB device..... USB Mass storage class
Interface..... USB2.0 (Full speed) USB1.1 compatible
File system..... FAT 16/32
Supply current..... Max. 1 A

[Tuner]

FM tuner

Reception frequency range..... 87.5 MHz to 108 MHz
Antenna impedance..... 75 Ω unbalanced

AM tuner

Reception frequency range..... 531 kHz to 1,602 kHz

[CD player]

Scanning method..... Semiconductor laser

[Power supply, etc.]

Standby power consumption..... 0.5 W or less
Power consumption..... 65 W

Dimensions

Width..... 245 mm
Height..... 104 mm
Depth..... 309 mm
Weight (net)..... 5.7 kg

Notes:

- Kenwood follows a policy of continuous advancements in development. For this reason specifications may be changed without notice.
- Sufficient performance may not be exhibited at extremely cold locations (where water freezes).



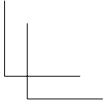
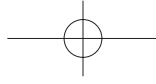
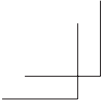

KENWOOD

For your records

Record the serial number, found on the back of the unit, in the spaces designated on the warranty card, and in the space provided below. Refer to the model and serial numbers whenever you call upon your dealer for information or service on this product.

Model _____

Serial Number _____

1111KMYMODCDT

