

# KENWOOD

## DPX405BT DPX305U

DUAL DIN SIZED CD RECEIVER

### Quick Start Guide

RECEPTEUR CD FORMAT DUAL DIN

### Guide de démarrage rapide

DUALER DIN-GENORMTER CD-RECEIVER

### Kurzanleitung

CD-ONTVANGER VAN DUBBEL DIN-FORMAAT

### Snelstartgids

JVCKENWOOD Corporation



## Contents

About the Quick Start Guide.....	2
Before use .....	3
Preparations/ Basic Operations.....	4
Playing Music (CD/USB/iPod).....	5
Listening to the Radio.....	6
Hands-free phoning.....	7
Installation accessories.....	8
Installation Procedure .....	8
Before Installation.....	8
Connecting Wires to Terminals.....	9
Installing the trim plate/Installation .....	12
Removing the Unit.....	12
Installing the Microphone unit .....	13
Appendix .....	15

## About the Quick Start Guide

This Quick Start Guide describes basic functions of this unit.

For functions not described in this Guide, refer to the Instruction Manual stored in the enclosed CD-ROM.

To refer to the Instruction Manual, a browser such as Internet Explorer® 7 or later, Firefox® 3.6 or later, Chrome™ 20 or later, Safari® 5.1 or later, iOS Safari® 4.0 or later, or Android™ 2.2 or later is required.

The Instruction Manual is subject to change for modification of specifications, etc. The latest Instruction Manual can be downloaded from the following website:

[manual.jvckenwood.com/edition/im369/](http://manual.jvckenwood.com/edition/im369/)



*The illustrations of the display and panel appearing in this manual are examples used to explain more clearly how the controls are used. Therefore, what appears on the display in the illustrations may differ from what appears on the display on the actual equipment, and some of the images on the display may be inapplicable.*

### CAUTION

- Keep battery out of reach of children and in original package until ready to use. Dispose of used batteries promptly. If swallowed, contact a physician immediately.
- The battery pack or batteries shall not be exposed to excessive heat such as sunshine, fire or the like.
- Do not set the remote control in hot places such as on the dashboard.
- The Lithium battery is in danger of explosion if replaced incorrectly. Replace it only with the same or equivalent type.

## Before use

### ▲ WARNING

#### To prevent injury or fire, take the following precautions:

- Stop the car before operating the unit.
- To prevent a short circuit, never put or leave any metallic objects (such as coins or metal tools) inside the unit.

### ▲ CAUTION

- Adjust the volume so that you can hear sounds outside the car. Driving with the volume too high may cause an accident.
- Wipe off the dirt on the panel with a dry silicon or soft cloth.  
Failure to observe this precaution may result in damage to the monitor or unit.\*

### Condensation

When the car is air-conditioned, moisture may collect on the laser lens. This may cause disc read errors. In this case, remove the disc and wait for the moisture to evaporate.

### Notes

- If you experience problems during installation, consult your Kenwood dealer.
- When you purchase optional accessories, check with your Kenwood dealer to make sure that they work with your model and in your area.
- Characters that conform to ISO 8859-5 or ISO 8859-1 can be displayed. Refer to "RUSSIAN SET" of <11-6. Initial settings>(Instruction Manual).
- The Radio Data System feature won't work where the service is not supported by any broadcasting station.

### About discs used with this unit

- This unit can only play the CDs with 
- The following discs cannot be used:
  - Discs that are not round
  - Discs with coloring on the recording surface or discs that are dirty
  - Recordable/Rewritable disc that has not been finalized (For the finalization process, refer to your disc writing software, and your disc recorder instruction manual.)
  - 8 cm (3 inch) disc (Attempt to insert using an adapter can cause malfunction.)

### Handling discs

- Do not touch the recording surface of the disc.
- Do not stick tape etc. on the disc, or use a disc with tape stuck on it.
- Do not use any accessories for the disc.
- Do not use any solvents to clean discs. Use a dry silicon or soft cloth.
- Clean from the center of the disc and move outward.
- When removing discs from this unit, pull them out horizontally.
- Remove the rims from the center hole and disc edge before inserting a disc.

### How to reset your unit

If the unit fails to operate properly, press the Reset button. The unit returns to factory settings.

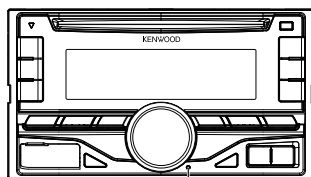

Reset button

# Preparations/ Basic Operations

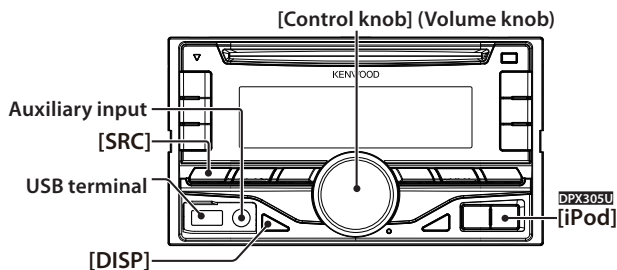

## Canceling the Demonstration Mode

Cancel the demonstration mode when you use it for the first time after installation.

- 1 Press the **[Control knob]** to cancel the Demonstration mode when the message "CANCEL DEMO PRESS VOLUME KNOB" appears (approx. 15 seconds).
- 2 Turn the **[Control knob]** to select "YES", and then press the **[Control knob]** knob. The demonstration mode can also be canceled in the Function setting mode. Refer to <11-3. Demonstration mode setting> of Instruction manual.

## Adjusting the Clock

- 1 Press and hold the **[Control knob]**.
- 2 Turn the **[Control knob]** to adjust the hour, and then press the **[Control knob]**.
- 3 Turn the **[Control knob]** to adjust the minute, and then press the **[Control knob]**.

## Power

Press the **[SRC]** button to turn on the power.  
Press and hold the **[SRC]** button to turn off the power.

## Volume

Turn the **[Control knob]** to adjust the sound volume.

## Attenuator

Press the **[Control knob]**.  
Turning the volume down quickly.

## Source selection

Press the **[SRC]** button repeatedly to select a sources.

Source	Display
Standby	"STANDBY"
Tuner	"TUNER"
USB or iPod <sup>(1)</sup>	"USB" or "iPod"
aha (Function of DPX405BT) <sup>(1)</sup>	"AHA"
Bluetooth audio (Function of DPX405BT)	"BT AUDIO"
CD <sup>(1)</sup>	"CD"
Auxiliary Input	"AUX"

<sup>(1)</sup> This source can be selected only when it can be played.

### DPX305U

Press the **[iPod]** button to switch the source to iPod.

## USB terminal

A USB device or iPod can be connected.  
The CA-U1EX (optional accessories) or KCA-iP102 (optional accessories) is recommended to connect a USB device or iPod.

## Auxiliary input

Portable audio device can be connected with the stereo mini-plug (3.5 mm  $\varnothing$ ).

## Display selection

Each time you press the **[DISP]** button, another display mode will be selected.  
Refer to <10-4. Text Display Selection> of Instruction manual

## Display scroll

Press and hold the **[DISP]** button to scroll the CD or Audio file text display.

# Playing Music (CD/USB/iPod)

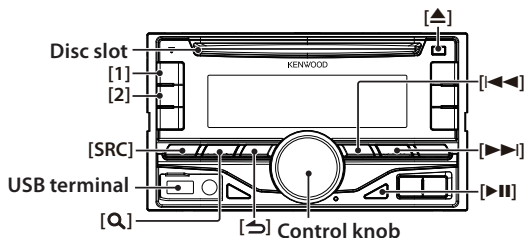

## Playing Disc

Insert a disc in the **Disc slot**.

When it is inserted, the source is switched automatically and playback starts.

## Playing USB device

Connect a USB device or iPod to the **USB terminal** as shown above.

When it is connected, the source is switched automatically and playback starts.

(USB terminal maximum supply current: DC 5 V  
⎓ 1 A)

## Selecting an Audio file folder

Press the [1] button to select a next folder.

Press the [2] button to select a previous folder.

## Selecting a Song

Press the [◀◀] or [▶▶] button to select a song.

## Fast Forward or Fast Backward of the Song

Press and hold the [◀◀] or [▶▶] button to fast-forward or fast-backward the song (tracks or files).

## Pause and play

Press the [▶||] button to pause or resume playing a song (track or file).

## Music Search

Searching for the song you want to play.

- 1 Press the [Q] button.
- 2 Search for music.

Operation type	Operation
Selecting items	Turn the [Control knob].
Determining selection	Press the [Control knob].
Returning to a previous item	Press the [↵] button.

To cancel music search in audio files or iPod, press and hold the [↵] button.

## Ejecting Disc

Press the [▲] button to eject a disc.

## Removing USB device/ iPod

Press the [SRC] button to switch the source other than USB, iPod, and aha, and then remove the USB device/ iPod.

Data contained in the USB device/ iPod may be damaged if you remove it when it is used as the active source.

## Listening to the Radio

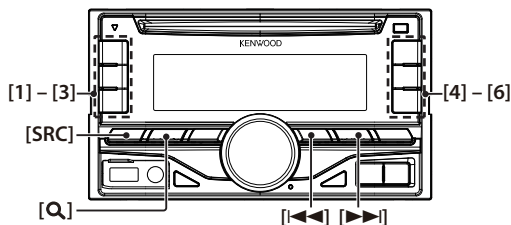

### Selecting a Tuner source

Press the **[SRC]** button to select "TUNER".

### Selecting the Band

Press the **[Q]** button to select FM1, FM2, FM3 or LW/MW.

### Selecting a Station

Press the **[-<<]** or **[>>-]** button to select the station you want to listen to.

### Station preset memory

Press and hold the button (**[1]** to **[6]**) to assign the selected station.

### Recalling the stations in the memory

Press the button (**[1]** to **[6]**) corresponding to the station you want to listen to.

## Hands-free phoning

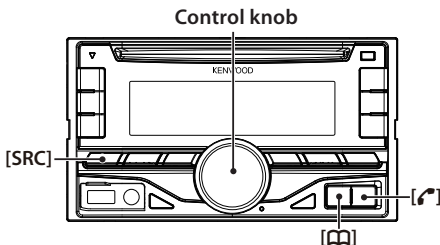

### Registering a Bluetooth device

You can register your Bluetooth device in this unit.

- 1 Press the **[SRC]** to turn on the power.
- 2 Start registering this unit by operating the Bluetooth device.  
By operating the Bluetooth device, register the hands-free unit (pairing). Select "DPX4\*\*BT" (for DPX405BT) from the list of found units.
- 3 If "PAIRING PASS \*\*\*\*\* (Bluetooth device name) PRESS VOLUME KNOB" appears, proceed to step 5.
- 4 Input the PIN code ("0000") in the Bluetooth device. Check that registration is complete on the Bluetooth device.  
"PAIRING PASS \*\*\*\*\* (Bluetooth device name) PRESS VOLUME KNOB" appears.  
PIN code is set to "0000" as the default. You can change this code. Refer to <15-1. Registering the PIN code> of Instruction manual.
- 5 Press the **[Control knob]**.  
Connection to your Bluetooth device starts, "PAIRING OK" appears a while later, and then the previous source is selected.  
When registration of your cell-phone is completed, the phone book of the cell-phone is automatically downloaded to this unit. (If the phone book has not been downloaded to this unit, operate the cell-phone to download it.)

### About automatic connection of the iPod touch or iPhone through Bluetooth

- This unit is compatible with an Apple Auto Pairing function. Connecting the iPod touch or iPhone to this unit with USB cable will automatically register it as a Bluetooth device.
  1. The Bluetooth function of the iPod touch or iPhone is turned on first.
  2. Connect an iPod touch or iPhone to the USB terminal.
  3. Press the **[Control knob]** to pair once you have confirm the passcode.

### Dialing a number in the phone book

Dial the phone number in the phone book of your cell-phone.

If the phone book has not been downloaded to this unit, operate the cell-phone to download it. Refer to <15-2. Downloading the phone book> of Instruction manual.

- 1 Press the **[Speaker icon]** button.
- 2 Turn the **[Control knob]** to select the name, and then press the **[Control knob]**.
- 3 Turn the **[Control knob]** to select a phone number.
- 4 Press the **[Speaker icon]** button.

### Answering a phone call

Press the **[Speaker icon]** button.

### Disconnecting a call

Press the **[Speaker icon]** button.

## Installation accessories

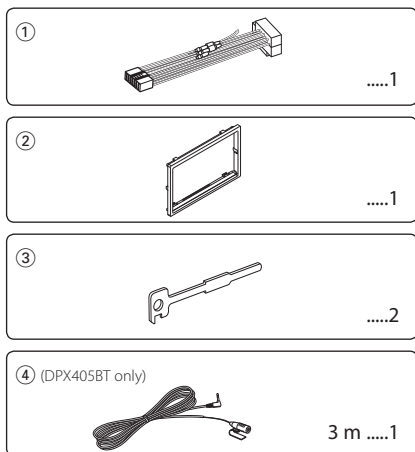

## Installation Procedure

1. To prevent a short circuit, remove the key from the ignition and disconnect the  $\ominus$  battery.
2. Make the proper input and output wire connections for each unit.
3. Connect the speaker wires of the wiring harness.
4. Connect the wiring harness wires in the following order: ground, battery, ignition.
5. Connect the wiring harness connector to the unit.
6. Install the unit in your car.
7. Reconnect the  $\ominus$  battery.
8. Press the reset button.

## Before Installation

### ▲WARNING

- The unit can only be installed in a car with a 12V DC power supply, negative ground.
- If you connect the ignition wire (red) and the battery wire (yellow) to the car chassis (ground), you may cause a short circuit, that in turn may start a fire. Always connect those wires to the power source running through the fuse box.

### ▲CAUTION

- Mounting and wiring this product requires skills and experience. For safety's sake, leave the mounting and wiring work to professionals.
- Make sure to ground the unit to a negative 12V DC power supply.
- Do not install the unit in a spot exposed to direct sunlight or excessive heat or humidity. Also avoid places with too much dust or the possibility of water splashing.
- Do not use your own screws. Use only the supplied screws. Using wrong screws, could damage the unit.
- If the power is not turned ON ("PROTECT" is displayed), the speaker wire may have a short-circuit or touched the chassis of the vehicle and the protection function may have been activated. Therefore, the speaker wire should be checked.
- If your car's ignition key switch does not have an ACC position, connect the ignition wires to a power source that can be turned on and off with the ignition key. If you connect the ignition wires to a constant-voltage power source, as with battery wires, the battery may die.
- If the console has a lid, make sure to install the unit so that the faceplate will not hit the lid when it is closed or opened.
- If the fuse blows, first make sure the wires are not touching other parts to cause a short circuit, and then replace the old fuse with one with a new the same rating.
- Insulate unconnected wires with vinyl tape or other similar materials. To prevent a short circuit, do not remove the caps on the ends of the unconnected wires and terminals.
- Connect the speaker wires correctly to the corresponding terminals. The unit may be damaged or fail to work if you share the  $\ominus$  wires or ground them to any metal part in the car.
- When connecting only two speakers, connect the connectors either to both of the front output terminals or to both of the rear output terminals (do not mix front and rear terminals). For example, if you connect the  $\oplus$  connector of the left speaker to a front output terminal, do not connect the  $\ominus$  connector to a rear output terminal.



## Connecting Wires to Terminals

### Connecting the ISO Connector

The pin arrangement for the ISO connectors depends on the type of the car. Make sure to make the proper connections to prevent damage to the unit.

The default connection for the wiring harness is described in [1] below. If the ISO connector pins are set as described in [2], make the connection as illustrated.

Please be sure to reconnect the cable as shown [2] below to install this unit to the **Volkswagen** vehicles etc.

- [1] (Default setting) The A-7 pin (red) of the vehicle's ISO connector is linked with the ignition, and the A-4 pin (yellow) is connected to the constant power supply.

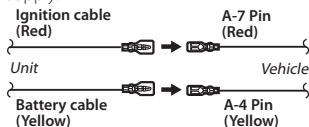

- [2] The A-7 pin (red) of the vehicle's ISO connector is connected to the constant power supply, and the A-4 pin (yellow) is linked to the ignition.

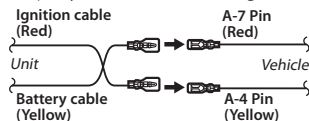

- After the installing the unit, check whether the brake lamps, blinkers, wipers, etc. on the car are working properly.
- Mount the unit so that the mounting angle is 30° or less.
- Reception may become poor if there are metal objects near the Bluetooth antenna. (DPX405BT only)

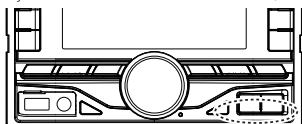

Bluetooth antenna unit

### For Good Reception

To assure good reception, note the following:

- Communicate with the cell-phone within the line-of-sight distance of 10 m (30 ft). The communication range becomes shorter depending on the surrounding environment. The communication range also becomes shorter when there is an obstacle between this unit and the cell-phone. The above maximum communication range (10 m) is not always assured.
- A broadcast station or walkie-talkie located nearby can interfere with communication due to a too strong signal.

### ⚠ CAUTION

Install this unit in the console of your vehicle. Do not touch the metal parts of this unit during and shortly after use of the unit. Metal parts such as the heat sink and enclosure become hot.

# Connecting Wires to Terminals

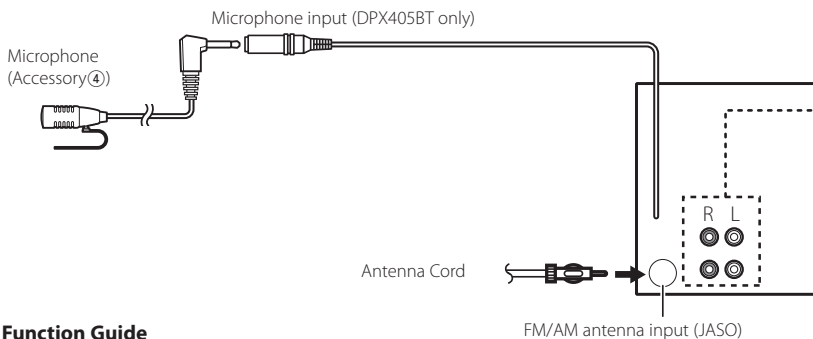

## Connector Function Guide

Pin Numbers for ISO Connectors	Cable Colour	Functions
<b>External Power Connector</b>		
A-4	Yellow	Battery
A-5	Blue/White	Power Control
A-6	Orange/White	Dimmer
A-7	Red	Ignition (ACC)
A-8	Black	Earth (Ground) Connection
<b>Speaker Connector</b>		
B-1	Purple	Rear Right (+)
B-2	Purple/Black	Rear Right (-)
B-3	Gray	Front Right (+)
B-4	Gray/Black	Front Right (-)
B-5	White	Front Left (+)
B-6	White/Black	Front Left (-)
B-7	Green	Rear Left (+)
B-8	Green/Black	Rear Left (-)

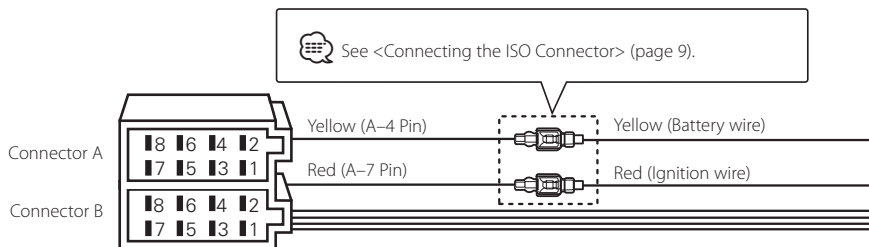

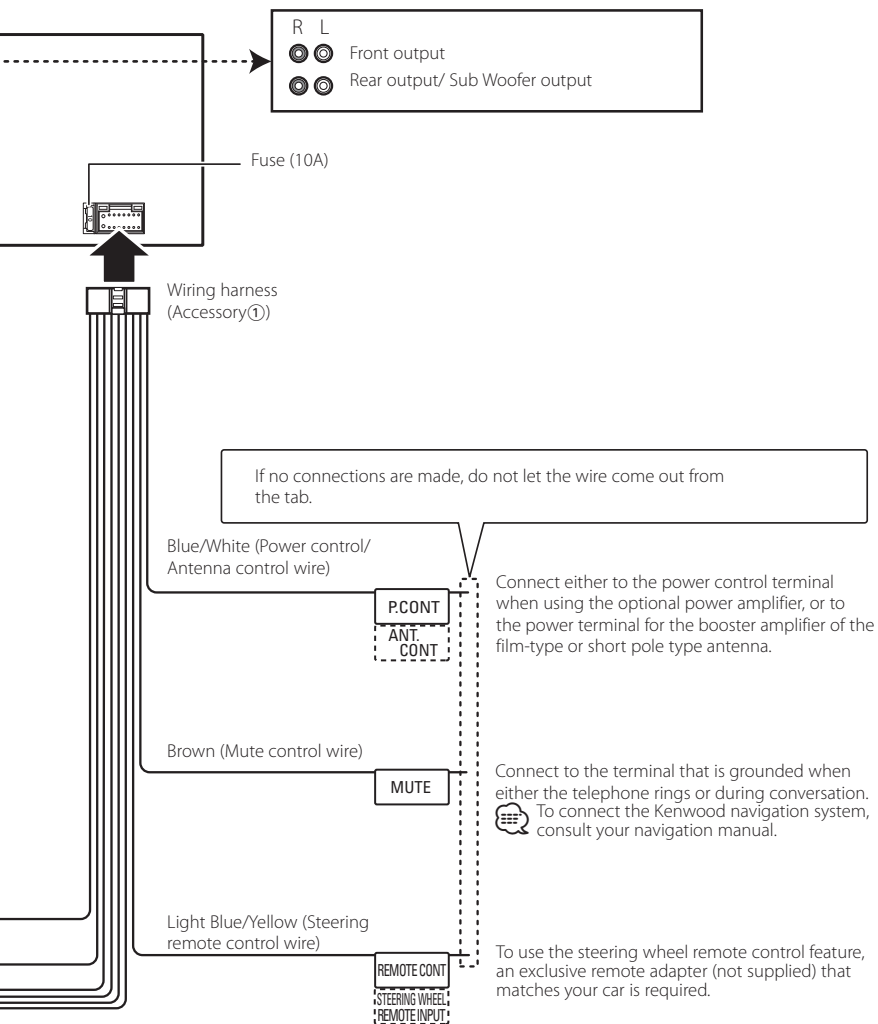

## Installing the trim plate/ Installation

### Installing the trim plate

Attach Accessory ② to the unit.

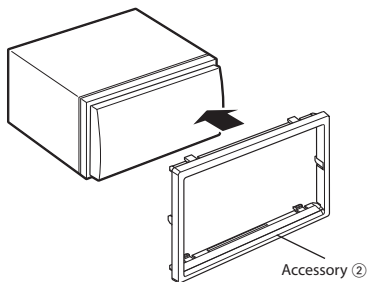

### Installation

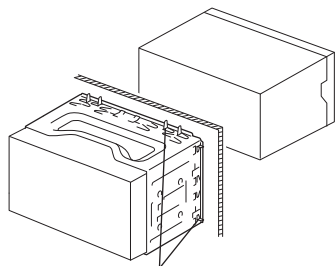

Bend the tabs of the mounting sleeve with a screwdriver or similar utensil and attach it in place.



- Make sure that the unit is installed securely in place. If the unit is unstable, it may malfunction (for example, the sound may skip).

## Removing the Unit

### Removing the trim plate

- 1 Engage the catch pins on the extraction key (Accessory ③) and remove the two locks on the lower level. Lower the frame and pull it forward as shown in the figure.

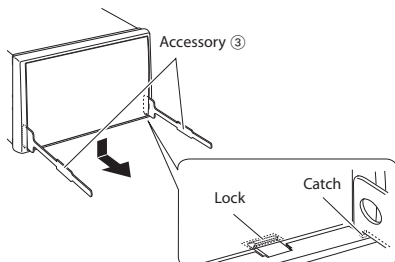

- The frame can be removed from the top side in the same manner.
- 2 When the lower level is removed, remove the upper two locations.

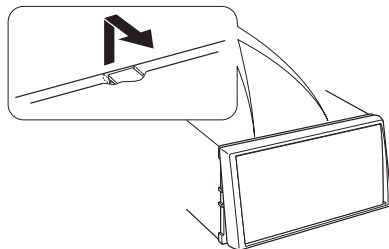

## Installing the Microphone unit

### Removing the Unit

- 1 Remove the trim plate by referring to the removal procedure in the section <Removing the trim plate>.
- 2 Insert the two extraction keys (Accessory ③) deeply into the slots on each side, as shown.

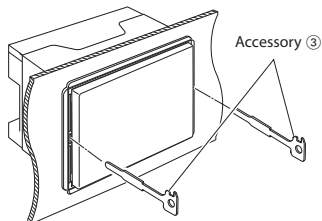

- 3 Lower the extraction key toward the bottom, and pull out the unit halfway while pressing towards the inside.

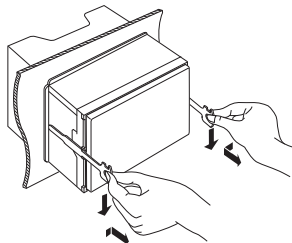

- Be careful to avoid injury from the catch pins on the extraction key.
- 4 Pull the unit all the way out with your hands, being careful not to drop it.

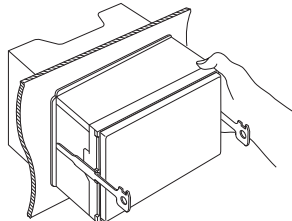

- 1 Check the installation position of the microphone (Accessory ④).
- 2 Remove oil and other dirt from the installation surface.
- 3 Install the microphone.
- 4 Lay the cable up to the unit with it secured at several positions using tape or the like.



- Install the microphone as far as possible from the cell-phone.

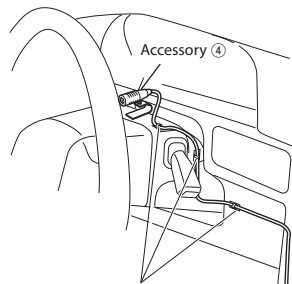

Fix a cable with a commercial item of tape.

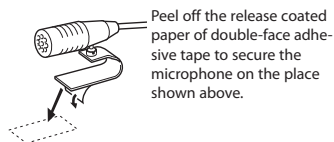

Peel off the release coated paper of double-face adhesive tape to secure the microphone on the place shown above.

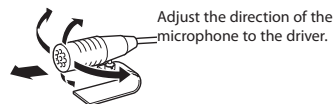

Adjust the direction of the microphone to the driver.

# Appendix

## About Audio file

- Playable Audio files  
AAC-LC (.m4a), MP3 (.mp3), WMA (.wma), WAV of USB device (.wav)
- Playable disc media  
CD-R/RW/ROM
- Playable disc file formats  
ISO 9660 Level 1/2, Joliet, Long file name.
- Playable USB devices  
USB mass storage class
- Playable USB device file systems  
FAT12, FAT16, FAT32

The online manual about audio files is put on the site, [www.kenwood.com/cs/ce/audiofile/](http://www.kenwood.com/cs/ce/audiofile/).

## iPod/iPhone that can be connected to this unit

Made for

- iPod touch (4th generation)
- iPod touch (3rd generation)
- iPod touch (2nd generation)
- iPod touch (1st generation)
- iPod classic
- iPod with video
- iPod nano (6th generation)
- iPod nano (5th generation)
- iPod nano (4th generation)
- iPod nano (3rd generation)
- iPod nano (2nd generation)
- iPod nano (1st generation)
- iPhone 4S
- iPhone 4
- iPhone 3GS
- iPhone 3G
- iPhone

For information on the compatibility with iPod/iPhone software, visit [www.kenwood.com/cs/ce/ipod/](http://www.kenwood.com/cs/ce/ipod/).

This Product is not installed by the manufacturer of a vehicle on the production line, nor by the professional importer of a vehicle into an EU Member State.

## Information on Disposal of Old Electrical and Electronic Equipment and Batteries (applicable for EU countries that have adopted separate waste collection systems)



Products and batteries with the symbol (crossed-out wheeled bin) cannot be disposed as household waste.

Old electrical and electronic equipment and batteries should be recycled at a facility capable of handling these items and their waste byproducts.

Contact your local authority for details in locating a recycle facility nearest to you.

Proper recycling and waste disposal will help conserve resources whilst preventing detrimental effects on our health and the environment.

Notice: The sign "Pb" below the symbol for batteries indicates that this battery contains lead.



Pb

## The marking of products using lasers



The label is attached to the chassis/case and says that the component uses laser beams that have been classified as Class 1. It means that the unit is utilizing laser beams that are of a weaker class. There is no danger of hazardous radiation outside the unit.

For Turkey

Bu ürün 28300 sayılı Resmi Gazete'de yayımlanan Atık Elektrikli ve Elektronik Eşyaların Kontrolü Yönetmeliğe uygun olarak üretilmiştir.

## Eski Elektrik ve Elektronik Ekipmanların İmha Edilmesi Hakkında Bilgi (ayrı atık toplama sistemlerini kullanan ülkeleri için uygulanabilir)



Sembollü (üzerinde çarpı işareti olan çöp kutusu) ürünler ev atıkları olarak atılamaz.

Eski elektrik ve elektronik ekipmanlar, bu ürünleri ve ürün atıklarını geri dönüştürebilecek bir tesiste değerlendirilmelidir. Yaşadığınız bölgeye en yakın geri dönüşüm tesisinin yerini öğrenmek için yerel makamlara müracaat edin. Uygun geri dönüşüm ve atık imha yöntemi sağladığımız ve çevremiz üzerindeki zararlı etkileri önlerken kaynakların korunmasına da yardımcı olacaktır.

## Requirements Aha™:

Requirements for listening to the Aha™ are as follows:

### iPhone or iPod touch

- Use an Apple iPhone or iPod touch running iOS4 or later.
- Search for "Aha" in the Apple iTunes App Store to find and install the most current version of the Aha™ application on your device.
- iPhone/ iPod touch connected to this unit with a KCA-iP102.

### Android™

- Use Android OS 2.2 or later.
- Download the Aha™ application to your smartphone from the Google play.
- Bluetooth must be built in and the following profiles must be supported.
  - SPP (Serial Port Profile)
  - A2DP (Advanced Audio Distribution Profile)

### NOTE

- In the application on your device, log in and create a free account with Aha.
- Internet connection by 3G, LTE, EDGE, or WiFi.
- Because Aha™ is a third-party service, the specifications are subject to change without prior notice. Accordingly, compatibility may be impaired or some or all of the services may become unavailable.
- Some Aha™ functionality cannot be operated from this unit.

## Specifications

### FM tuner section

Frequency range (50 kHz step)  
: 87.5 MHz – 108.0 MHz  
Usable sensitivity (S/N = 26dB)  
: 0.63  $\mu$ V/75  $\Omega$   
Quieting Sensitivity (DIN S/N = 46dB)  
: 1.6  $\mu$ V/75  $\Omega$   
Frequency response ( $\pm 3$  dB)  
: 30 Hz – 15 kHz  
Signal to Noise ratio (MONO): 75 dB  
Stereo separation (1 kHz): 45 dB

### MW tuner section

Frequency range (9 kHz step)  
: 531 kHz – 1611 kHz  
Usable sensitivity (S/N = 20dB)  
: 36  $\mu$ V

### LW tuner section

Frequency range  
: 153 kHz – 279 kHz  
Usable sensitivity (S/N = 20dB)  
: 57  $\mu$ V

### CD player section

Laser diode: GaAlAs  
Digital filter (D/A)  
: 8 Times Over Sampling  
D/A Converter: 24 Bit  
Spindle speed (Audio files)  
: 500 – 200 rpm (CLV)  
Wow & Flutter: Below Measurable Limit  
Frequency response ( $\pm 1$  dB)  
: 20 Hz – 20 kHz  
Total harmonic distortion (1 kHz)  
: 0.01 %  
Signal to Noise ratio (1 kHz): 105 dB  
Dynamic range: 90 dB  
MP3 decode: Compliant with MPEG-1/2 Audio Layer-3  
WMA decode: Compliant with Windows Media Audio  
AAC decode: AAC-LC ".m4a" files

### USB interface

USB Standard: USB1.1/ 2.0 (Full speed)  
File System : FAT12/ 16/ 32  
Maximum Supply current  
: DC 5 V  $\overline{\text{L}}\text{A}$   
MP3 decode  
: Compliant with MPEG-1/2 Audio Layer-3  
WMA decode: Compliant with Windows Media Audio  
AAC decode: AAC-LC ".m4a" files  
WAV decode: Linear-PCM

### Audio section

Maximum output power: 50 W x 4  
Output power (DIN 45324, +B=14.4V) : 30 W x 4  
Speaker Impedance: 4 – 8  $\Omega$   
Tone action  
Bass : 100 Hz  $\pm 8$  dB  
Middle : 1 kHz  $\pm 8$  dB  
Treble : 12.5 kHz  $\pm 8$  dB  
Preout level/ Load (CD): 2500 mV/10 k $\Omega$   
Preout impedance:  $\leq 600 \Omega$

### Bluetooth section (DPX405BT only)

Version: Bluetooth Ver.2.1+EDR Certified  
Frequency range: 2.402 – 2.480 GHz  
Output Power: +4dBm (MAX), 0dBm (AVE)  
Power Class 2  
Maximum Communication range  
: Line of sight approx.10m  
Profiles  
: HFP (Hands Free Profile)  
: SPP (Serial Port Profile)  
: PBAP (Phonebook Access Profile)  
: OPP (Object Push Profile)  
: A2DP (Advanced Audio Distribution Profile)  
: AVRCP (Audio/Video Remote Control Profile)

### Auxiliary input

Frequency response ( $\pm 3$  dB)  
: 20 Hz – 20 kHz  
Input Maximum Voltage: 1200 mV  
Input Impedance: 10 k $\Omega$

### General

Operating voltage  
DPX405BT: 14.4 V (10.5 – 16V allowable)  
DPX305U: 14.4 V (11 – 16V allowable)  
Maximum Current consumption: 10 A  
Installation Size (W x H x D)  
: 182 x 111 x 157 mm  
Weight: 1.5 kg

- The Bluetooth word mark and logos are owned by the Bluetooth SIG, Inc. and any use of such marks by JVC KENWOOD Corporation is under license. Other trademarks and trade names are those of their respective owners.
- The "AAC" logo is a trademark of Dolby Laboratories.
- "Made for iPod" and "Made for iPhone" mean that an electronic accessory has been designed to connect specifically to iPod or iPhone, respectively, and has been certified by the developer to meet Apple performance standards. Apple is not responsible for the operation of this device or its compliance with safety and regulatory standards. Please note that the use of this accessory with iPod or iPhone may affect wireless performance.
- iPhone, iPod, iPod classic, iPod nano, and iPod touch are trademarks of Apple Inc., registered in the U.S. and other countries.
- iTunes and Safari are trademark of Apple Inc.

- iOS is a trademark or registered trademark of Cisco in the U.S. and other countries and is used under license.
- Android and Chrome are trademark of Google Inc.
- Internet Explorer and Windows Media are registered trademark of Microsoft Corporation in the United States and other countries.
- Firefox is a registered trademark of Mozilla Foundation in the United States and other countries.
- aha, the Aha logo, and the Aha trade dress are trademarks or registered trademarks of HARMAN International Industries, used with permission.
- BlackBerry®, RIM®, Research In Motion® and related trademarks, names and logos are the property of Research In Motion Limited and are registered and/or used in the U.S. and countries around the world. Used under license from Research In Motion Limited.