

DNN9230DAB

CONNECTED NAVIGATION SYSTEM INSTRUCTION MANUAL

JVC KENWOOD Corporation

Before reading this manual, click the button below to check the latest edition and the modified pages.
<http://manual.kenwood.com/edition/im365/>

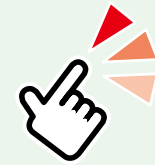

What Do You Want To Do?

Thank you for purchasing the KENWOOD CONNECTED NAVIGATION SYSTEM.
In this manual, you will learn various convenient functions of the system.

Click the icon of the media you want to play.

With one-click, you can jump to the section of each media!

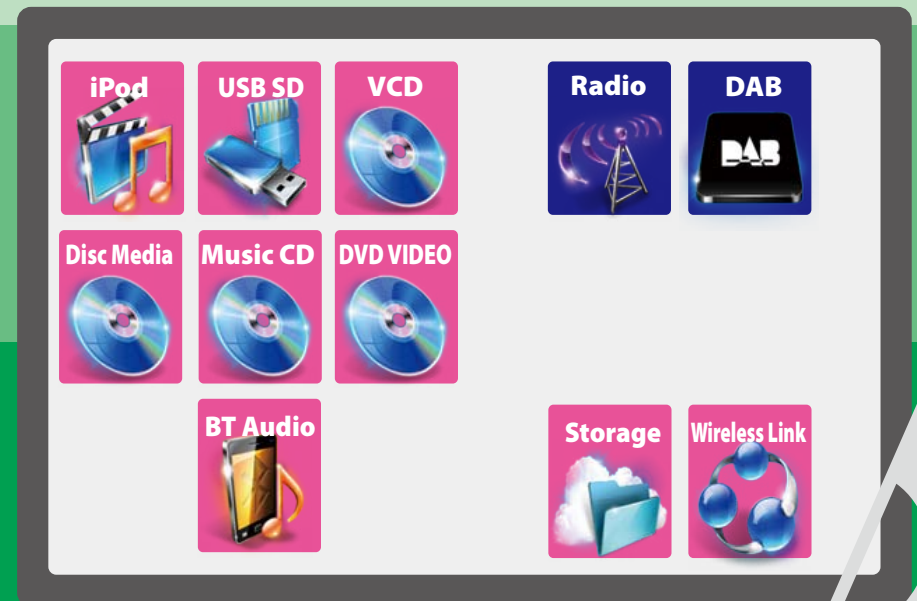

Contents

Before Use 4

▲ WARNING _____ 4

How to Read this Manual 6

Features of Navigation systems 8

Basic Operations 10

Functions of the Buttons
on the Front Panel _____ 10

Turning on the Navigation System _____ 12

How to Play Media _____ 18

Operation on the Home Screen _____ 20

Common Operation _____ 24

Navigation Operation _____ 26

Wi-Fi Setup 28

Wi-Fi Setup _____ 28

Clock and Date Setup 30

Clock and Date Setup _____ 30

Account Setup 32

About Account _____ 32

Create User Account _____ 32

Set Owner Account _____ 33

Set User Account _____ 34

Switch the User Login _____ 34

Delete User Account _____ 35

Reset Owner Account _____ 35

Widget and Application Operation 36

Weather Widget _____ 36

Weather Application _____ 36

Today Widget _____ 39

SNS Widget _____ 39

RSS Widget _____ 40

Schedule Application _____ 40

SNS Application _____ 43

RSS Application _____ 46

Now playing Widget _____ 48

Network Media History Widget _____ 50

Photo Frame Widget _____ 51

Mixed Media Search _____ 52

DVD/Video CD (VCD) Operation 54

DVD/VCD Basic Operation _____ 54

DVD Disc Menu Operation _____ 57

Zoom Control for DVD and VCD _____ 58

DVD Setup _____ 59

CD/Audio and Visual Files/iPod Operation 62

Music/Video Basic Operation _____ 62

Search Operation _____ 68

Movie Control _____ 72

USB/SD/iPod/DivX Setup _____ 72

Cloud Storage Operation 74

Starting procedure _____ 74

Music Basic Operation _____ 74

Category search _____ 75

Kenwood Wireless Link Operation 76

Starting procedure _____ 76

Media Server function _____ 77

Media Player function _____ 77

Media Controller function _____ 78

Media Renderer function _____ 79

Radio Operation 80

Radio Basic Operation _____ 80

Digital Radio Basic Operation _____ 82

Memory Operation _____ 84

Selecting Operation _____ 84

Traffic Information _____ 86

Replay (Digital Radio only) _____ 86

Tuner Setup _____ 87

DAB Setup _____ 88

Streaming Service Application 90

Streaming Video Application _____ 90

AUPEO! Application _____ 92

Bluetooth Control 94

Registering and Connecting
Bluetooth Unit _____ 94

Playing Bluetooth Audio Device _____ 97

Using Hands-Free Feature _____ 98

Hands-Free Setup _____ 102

SMS (Short Message Service) _____ 104

Voice Control 106

Voice Control _____ 106

Camera Control 107

Camera Control _____ 107

Switching the View Camera _____ 107

Setting Up 108

Monitor Screen Setup _____ 108

System Setup _____ 109

Display Setup _____ 112

Navigation Setup _____ 114

Camera Setup _____ 115

Software Information _____ 116

AV Input Setup _____ 116

AV Output Interface Setup _____ 117

Controlling Audio 118

Setting Audio _____ 118

Controlling General Audio _____ 121

Equalizer Control _____ 122

Sound Effect _____ 123

Zone Control _____ 125

Listening Position _____ 126

Remote Control 128

Battery Installation _____ 128

Functions of the Remote Control Buttons _____ 129

Troubleshooting 132

Problems and Solutions _____ 132

Error Messages _____ 133

Resetting the Navigation System _____ 135

Appendix 136

Playable Media and Files _____ 136

Status Bar Indicator Items _____ 139

Region Codes in the World _____ 141

DVD Language Codes _____ 142

Specifications _____ 143

Trademarks _____ 146

Safety precaution _____ 148

Before Use

⚠ WARNING

📄 To prevent injury or fire, take the following precautions:

- To prevent a short circuit, never put or leave any metallic objects (such as coins or metal tools) inside the unit.
- Do not watch or fix your eyes on the unit's display when you are driving for any extended period.
- If you experience problems during installation, consult your Kenwood dealer.

📄 Precautions on using this unit

- When you purchase optional accessories, check with your Kenwood dealer to make sure that they work with your model and in your area.
- You can select language to display menus, audio file tags, etc. See [Language setup \(P.110\)](#).
- The Radio Data System or Radio Broadcast Data System feature won't work where the service is not supported by any broadcasting station.

📄 Protecting the monitor

To protect the monitor from damage, do not operate the monitor using a ball point pen or similar tool with the sharp tip.

📄 Cleaning the unit

If the faceplate of this unit is stained, wipe it with a dry soft cloth such as a silicon cloth. If the faceplate is stained badly, wipe the stain off with a cloth moistened with neutral cleaner, then wipe it again with a clean soft dry cloth.



- Applying spray cleaner directly to the unit may affect its mechanical parts. Wiping the faceplate with a hard cloth or using a volatile liquid such as thinner or alcohol may scratch the surface or erase screened print.

📄 Lens fogging

When you turn on the car heater in cold weather, dew or condensation may form on the lens in the disc player of the unit. Called lens fogging, this condensation on the lens may not allow discs to play. In such a situation, remove the disc and wait for the condensation to evaporate. If the unit still does not operate normally after a while, consult your Kenwood dealer.

📄 Precautions on handling discs

- Do not touch the recording surface of the disc.
- Do not stick tape etc. on the disc, or use a disc with tape stuck on it.
- Do not use disc type accessories.
- Clean from the center of the disc and move outward.
- When removing discs from this unit, pull them out horizontally.
- If the disc center hole or outside rim has burrs, use the disc only after removing the burrs with a ballpoint pen etc.
- Discs that are not round cannot be used.

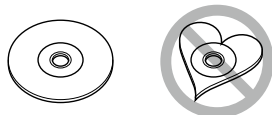

- 8-cm (3 inch) discs cannot be used.
- Discs with coloring on the recording surface or discs that are dirty cannot be used.
- This unit can only play the CDs with . This unit may not correctly play discs which do not have the mark.
- You cannot play a disc that has not been finalized. (For the finalization process see your writing software, and your recorder instruction manual.)

📄 About the personal information stored in this unit

Before giving or selling this unit to others, be sure to delete the information (mail, search logs, etc.) stored in this unit by yourself and confirm that the data has been deleted.

We shall not be liable for any damage caused by leakage of undeleted data.

How to delete

1 | Press the <HOME> button.

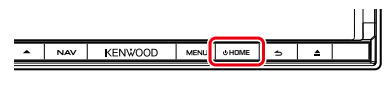

2 | Press the <MENU> button.



3 | Touch [Settings].



4 | Touch [Backup & Reset].

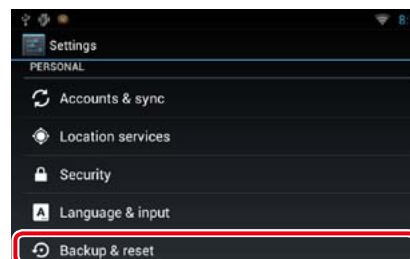

5 | Touch [Factory data reset].

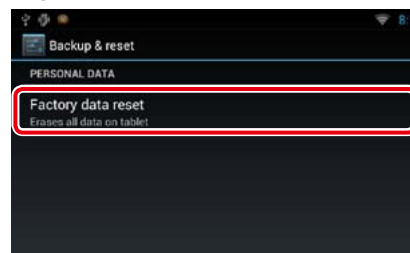

6 | Touch [Reset device].

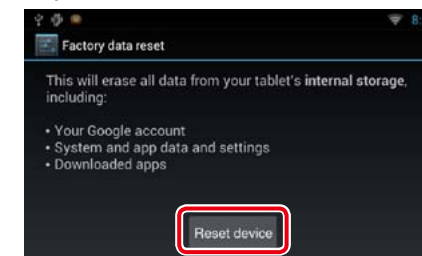

7 | Touch [Erase everything].

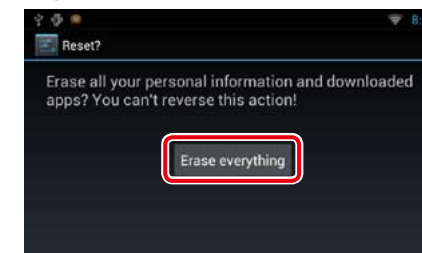

How to Read this Manual

[Return to the Top page](#)
[CD, Disc, iPod, USB device](#)

Search Operation

You can search music, video or picture files by the following operations.

NOTE

- If you use a remote controller, you can jump directly to the desired track/file with entering the track/folder/file number, play time, etc. For details, see [Direct search mode \(P.149\)](#).

List search

You can search tracks, folders, and files according to hierarchy.

1 | Touch illustrated area.
List Control screen appears.

2 | Touch desired track/file.

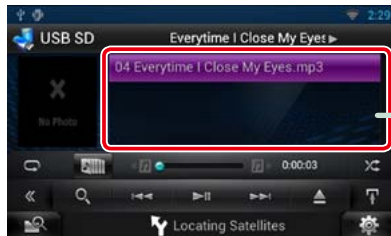

Playback starts.

Other search

When you want to narrow the list down, there are other search ways.
This function is not available when music CD is the current source.

1 | Touch [Q] in the control screen.
The search type screen appears.

2 | Touch desired search way.

Link header

You can refer each section or top page with one-click.

Operation title

Introduces the function.

NOTE

Introduces some tips, notes, etc.

Reference mark

Displayed in blue notes.

With one-click, you can jump to the article related to the current section.

Operation procedure

Explains necessary procedures to achieve the operation.

< >: Indicates the name of panel buttons.

[]: Indicates the name of touch keys.

Screen shot

Shows some screen shots displayed during operation for reference.

The area or keys to touch are surrounded with a red frame.

NOTE

- The screens and panels shown in this manual are examples used to provide clear explanations of the operations. For this reason, they may be different from the actual screens or panels used, or some display patterns may be different.

Features of Navigation systems

By connecting this navigation system to Internet, you can use various services.

Cooperation with Route Collector site

- Destinations and routes specified on the PC can be input to this navigation system.
- The routes you have traveled and the songs you have listened to can be logged. [\(P.27\)](#)
- By uploading music files to Dropbox and creating a play list on Route Collector site, you can listen to music anywhere through streaming without music files on this navigation system. [\(P.74\)](#)
- Speech to Text (STT) and Text to Speech (TTS).

Use of internet service

- Streaming service such as YouTube, Aupeo!.
- Internet service such as email, Gmail, Google calendar, and social networking service such as Facebook and Twitter.
- Information (weather, traffic, RSS, etc.) service.

Wi-Fi access point

- Connect to Internet using the tethering function of your smartphone or an Internet device.

3G, LTE or EDGE

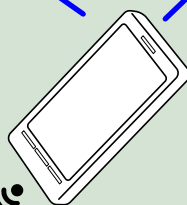

Wi-Fi (11n/g/b)

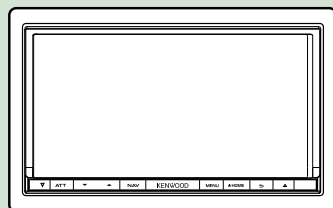

About the account

- To use internet services via this system, you need to create an account in the Route Collector site.
- In addition to the owner account, you can register up to four user accounts.
- You can use a guest account as well.
- By switching among accounts, you can secure the privacy when using the mail feature or social media.

For details, see [About Account \(P.32\)](#).
<http://www.route-collector.com/>

Notes

You can use following feature for 2 years after registration of the owner account. To use it continuously, a usage fee is required. For details, see web site of Route Collector.

<http://www.route-collector.com/>

- Weather (by INRIX)
- Traffic (by INRIX)
- Dynamic Parking (by INRIX)
- Fuel Prices (by INRIX)
- Real-Time Traffic Camera (by INRIX)
- Movie Show Times (by WWM)
- TTS (by Nuance)
- STT (by Nuance)

To use the following services, you need to register the corresponding free or paid accounts.

- Aupeo!
- Facebook
- Twitter
- Gmail (by Google)
- Google calendar (by Google)
- Dropbox

- Media player for DVD video, CD, USB memory, SD card, iPod, etc.
- Digital Radio (DAB) and Analog Radio.
- Navigation

Basic Operations

Functions of the Buttons on the Front Panel

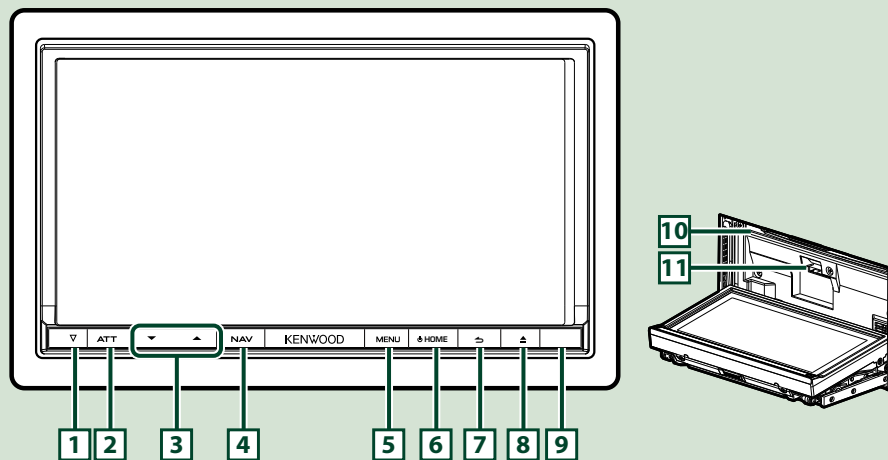

NOTE

The panels shown in this guide are examples used to provide clear explanations of the operations. For this reason, they may be different from the actual panels.

Number	Name	Motion
1	▽ (Reset)	<ul style="list-style-type: none"> If the unit or the connected unit fails to operate properly, the unit returns to initial settings when this button is pressed (P.135). If the SI function is turned on, this indicator flashes when the vehicle ignition is off (P.110).
2	ATT	<ul style="list-style-type: none"> Switches attenuation of the volume on/off. Pressing for 1 second turns the screen off.
3	▼, ▲ (Vol)	Adjusts volume.
4	NAV	<ul style="list-style-type: none"> Displays the navigation screen. Pressing for 1 second switches camera view display on/off.
5	MENU	<ul style="list-style-type: none"> Displays the option menu screen. Pressing for 1 second switches AV out sources.
6	HOME	<ul style="list-style-type: none"> Displays the Home screen (P.20). Pressing for 1 second turns the power off. When the power off, turns the power on.
7	↶ (Back)	<ul style="list-style-type: none"> Return to the previously viewed screen. Pressing for 1 second displays the Hands Free screen (P.94).
8	▲ (Eject)	<ul style="list-style-type: none"> Ejects the disc. When the panel is opened, pressing closes the panel and pressing for 1 second ejects the disc forcibly. When the panel is closed, pressing for 1 second fully opens the panel to the location of the SD card slot.
9	Remote Sensor	Receives the remote control signal.
10	Disc insert slot	A slot to insert a disc media.
11	SD card slot	A slot to insert an SD card.

Turning on the Navigation System

The method for turning on the power varies between different models.

- 1 Press the <HOME> button.

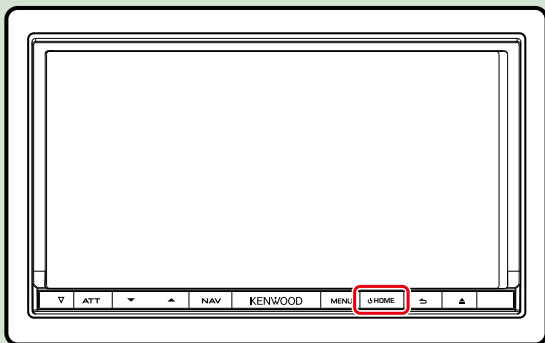

The navigation system is turned on.

- **To turn off the navigation system:**
Press the <HOME> button for 1 second.

If it is your first time turning the navigation system on after installation, it will be necessary to perform [Initial setup \(P.14\)](#).

Login

- 1 Select the login user.

When the owner has not been registered



When the owner has been registered



- 2 Enter the password.

When you selected Administrator or Guest, you do not need to enter a password.



[Auto Login?]: Checking this checkbox allows you to log in to the system automatically from the next time.

- 3 Touch [Login].

NOTE

- If you forgot your password, create your new password on the Route Collector site.
<http://www.route-collector.com/>

Initial setup

Perform this setup when you use this navigation system for the first time or when you reset the unit. See [Resetting the Navigation System \(P.135\)](#).

1 Set each item as follows.



Language Setup

Select the language used for the GUI and input methods. Default is "English (United States)".

- 1 Touch [Language Setup].
- 2 Select a language from the list.
- 3 After setting, press the < > button twice.

WiFi Setup

Configure settings for connection to Wi-Fi.

- 1 Touch [WiFi Setup].
- 2 Slide Wi-Fi to ON.
- 3 Select the Wi-Fi access point to register from the list.
- 4 Input the Password.
- 5 Touch [Connect].
- 6 After setting, press the < > button.

For details on operation, see [Wi-Fi Setup \(P.28\)](#).

Date Setup

Set the date and time.

- 1 Touch [Date Setup].
- 2 Touch [Select time zone].
- 3 Select a time zone.
- 4 After setting, press the < > button.

For details on operation, see [Clock and Date Setup \(P.30\)](#).

Account Setup

Set the information about the user of this navigation system.

- 1 Touch [Account Setup].

For details on operation, see [About Account \(P.32\)](#).

2 Touch [Next].

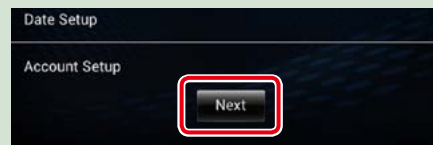

3 Set each item as follows.



Language

Select the language used for the control screen and setting items. Default is "American English (en)".

- 1 Touch [SET].
- 2 Touch [◀] or [▶] to select the desired language.
- 3 Touch [Enter].

For details on operation, see [Language setup \(P.110\)](#).

Angle

Adjust the position of the monitor. Default is "0".

- 1 Touch [SET].
- 2 Touch desired angle number and [↔].

For details on operation, see [Monitor angle control \(P.112\)](#).

iPod AV Interface Use

Set the terminal which your iPod is connected to. Default is "iPod".

- 1 Touch [iPod] or [AV-IN2].

Color

Set the screen and button illumination color. You can select whether to allow color scan operation or select a fixed color for operation.

- ① Touch [SET].
- ② Touch [ON] or [OFF] of [Panel Color Scan].
- ③ If you want to change color, touch [SET] of [Panel Color Coordinate].
- ④ Touch your desired color and [→].

For details on operation, see [Panel color coordinate \(P.113\)](#).

Camera

Set the parameters for the camera.

- ① Touch [SET].
- ② Set each item and touch [→].

For details on operation, see [Camera Setup \(P.115\)](#).

Demo mode

Set the demonstration mode. Default is "ON".

- ① Touch [ON] or [OFF].

4 Touch [Finish].



NOTE

- These settings can be set from the SETUP menu. See [Setting Up \(P.108\)](#).

How to Play Media

Music CD and disc media

- 1 Press the <▲> button.



The panel opens.

- 2 Insert the disc into the slot.

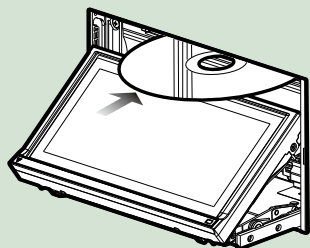

The panel closes automatically.

The unit loads the disc and playback starts.

- **To eject the disc:**
Press the <▲> button.

USB device

- 1 Connect the USB device with the USB cable.

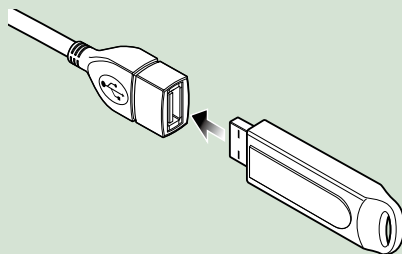

The unit reads the device and playback starts.

- **To disconnect the device:**
Touch [▲] on the screen and disconnect the device from the cable.

iPod

- 1 Connect the iPod with the iPod cable.

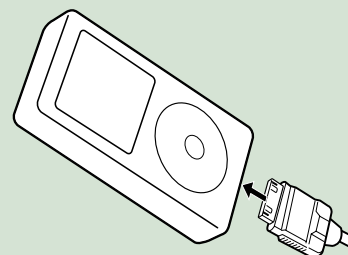

The unit reads the iPod and playback starts.

- **To disconnect the device:**
Touch [◀] on the screen and then touch [▲]. Disconnect the iPod from the cable.

SD card

- 1 Press the <▲> button for 1 second to open the front panel.

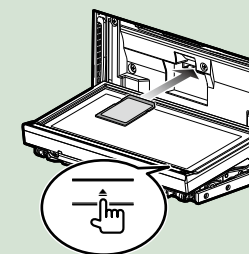

The panel fully opens.

- 2 Hold the SD card as the diagram below and insert it into the slot until it clicks.



The unit loads the card and playback starts.

- **To remove:**
Push the SD card until it clicks and then remove your finger from the card.
The card pops up so that you can pull it out with your fingers.

Operation on the Home Screen

Most functions can be operated on the Home screen.

1 Press the <HOME> button.

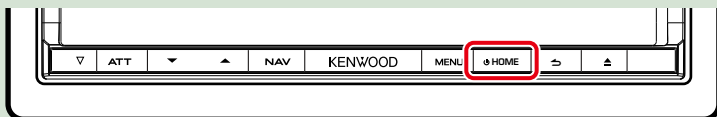

Home screen appears.

2 Select the Service panel, Media panel, Source launcher panel, or Network contents panel.

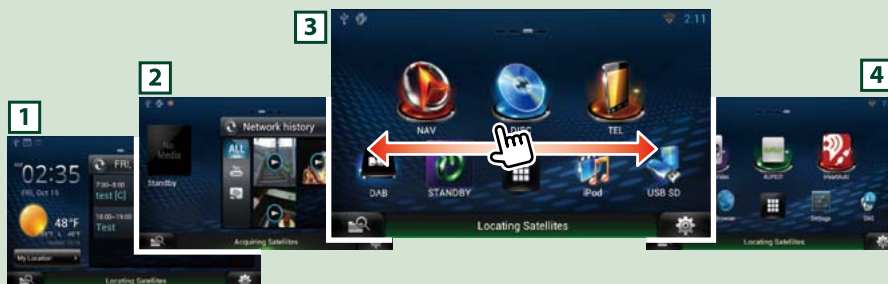

Panel	Description
1 Service panel	Weather widget: Displays the weather forecast for the selected region. Network widget: Displays the schedule, SNS, or RSS.
2 Media panel	Now playing: Displays the title of the song being played or the name of the station you are listening to, and allows you to perform simple operations. Media widget: Allows you to switch among Network media history for selecting a song from the history of the songs you listened to, and Photo frame for displaying a photo.
3 Source launcher panel	Allows you select a source.
4 Network contents panel	Allows you to select a network-related application.

Source launcher panel and Network contents panel

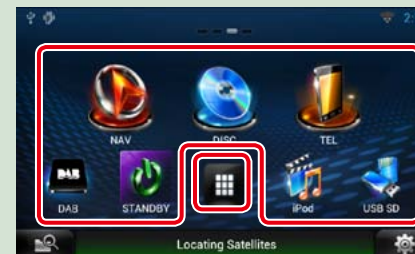

(Shortcut)

You can register sources and applications you use frequently so that you can start them quickly.

(All source list/ All apps list)

Displays all sources and applications.

All source list/ All apps list

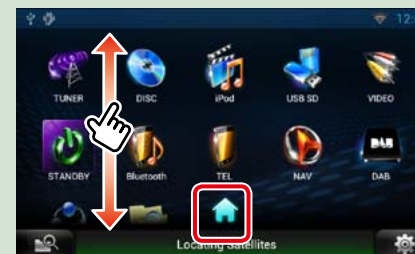

(All source list/ All apps list)

You can scroll the list screen by flicking the screen up/down.

(Home)

Returns to the Source launcher panel or the Network contents panel.

From All source list, you can perform the following functions.

Function	Icon	Operation
Switch the audio source	etc.	Touch the icon of the desired source.
Display navigation screen	or	Touch [NAV] or navigation information.
Turn off all audio function		Touch [STANDBY].

Moving or deleting of an icon on the Source launcher panel and Network contents panel

- 1 Touch and hold the icon.
- 2 Drag the icon to the desired position or Recycle Bin.



Adding of a shortcut icon to Source launcher panel or Network contents panel

- 1 Touch [] in Source launcher panel or Network contents panel.
- 2 Touching the icon continuously to display the Source launcher panel or Network contents panel screen.
- 3 Drag the icon to an empty space.

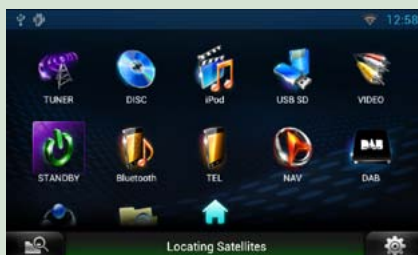

Media panel

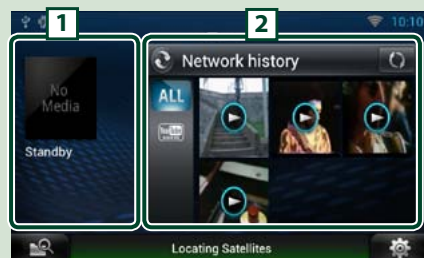

- 1 **Now playing widget**
 Displays the title of the song being played or the name of the station you are listening to, and allows you to perform simple operations. See [Now playing Widget \(P.48\)](#).
- 2 **Media widget**
 Touching [] allows you to switch among Network media history, and photo frame. See [Network Media History Widget \(P.50\)](#), [Photo Frame Widget \(P.51\)](#).

Service panel



- 1 **Weather widget**
 Displays the today's weather forecast. See [Weather Widget \(P.36\)](#).
- 2 **Network widget**
 Touching [] allows you to switch between Schedule, RSS, and SNS. See [Today Widget \(P.39\)](#), [SNS Widget \(P.39\)](#), [RSS Widget \(P.40\)](#).

Change the skin for home screen

You can select a home screen skin from 3 types.

- 1 Press the <MENU> button.
- 2 Touch [Theme].

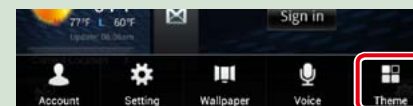

- 3 Select a skin.



- 4 Touch [OK].

Common Operation

Introduces the common operation.

General

There are some functions which can be operated from most screens.



Quick menu screen



(Mixed Media Search)

Touch to display the Mixed Media Search screen.

(Quick menu)

Touch to display the quick menu. The content of the menu are as follows.

- : Displays the SETUP Menu screen.
- : Displays the Audio Control Menu screen.
- : Displays the control screen of current source. Icon feature differs depending on the source.

List screen

There are some common function keys in the list screens of most sources.

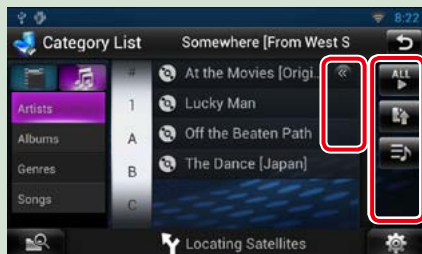

(Scroll)

Touch to scroll through texts on the display.

etc.

Touch keys with various functions are displayed here.

Displayed keys differ depending on the current audio source, status, etc.

For examples of functions of each key, refer to the table below.

Key	Function
	Lists all the music in the lower hierarchy.
	Moves to the upper hierarchy.
	Displays current category folder.
	Displays music/movie file list.

Flick scrolling

You can scroll the list screen by flicking the screen up/down or right/left.

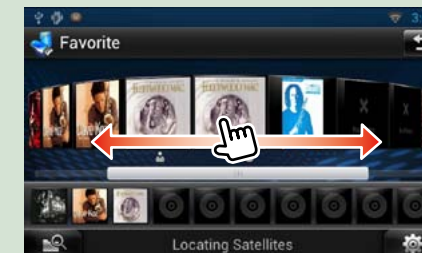
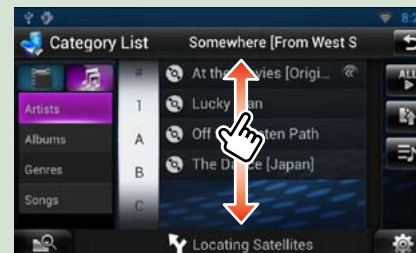

Navigation Operation

For details on the navigation function, please refer to the Navigation Instruction Manual.

Display the navigation screen

- 1 Press the <NAV> button.

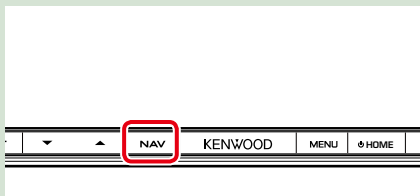

The navigation screen appears.

Control audio from the navigation screen

You can control audio sources while the navigation screen is displayed.

Also, you can view the navigation information while the source control screen is displayed.

- 1 Touch the information bar.



The navigation screen with audio information appears.

- 2 Touch [] or [] in the navigation screen.



Touching this area displays the audio screen.

: Displays the navigation and control keys of the current source.



: Displays the navigation and current video/picture playback display.



NOTE

- The screen switches between playback screen and camera view each time the viewing area is touched.
- Touching the source icon in the bottom of the screen displays the full audio screen.

- To return to the full navigation screen:

Touch [].

NOTE

- For details on control keys, refer to the instructions in each section.

Trip log function

You can upload the routes you traveled and the songs you listened to the Route Collector site so that you can confirm them later.

- 1 Press the <MENU> button in the navigation screen or source control screen.
- 2 Touch [Triplog On].

- 3 Touch [Yes].

When the Trip log is active, " " appears in the status bar.

NOTE

- You can use the Trip log function when you have logged in the system as Owner or User.

Wi-Fi Setup

Wi-Fi Setup

You can connect to a Wi-Fi access point to connect to Internet.

Preparation

- Make preparations for using the Wi-Fi access point for Internet connection through use of the tethering function of the smartphone.

1 | Press the <HOME> button to display the Home screen.

Note

- To display the Network contents panel, Press the <HOME> button again.

2 | Press the <MENU> button.

3 | Touch [Setting].



4 | Slide Wi-Fi to ON.

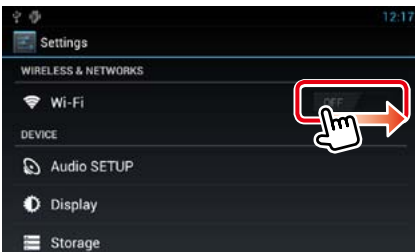

5 | Touch [Wi-Fi].

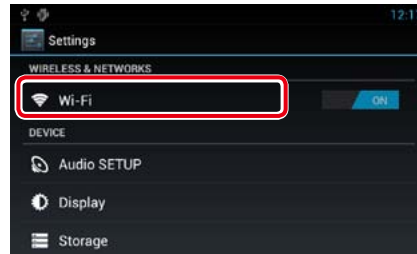

6 | Select the Wi-Fi access point to register from the list.

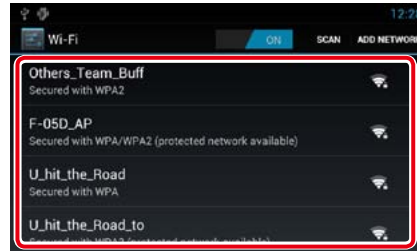

7 | Input the Password.



8 | Touch [Connect].

Register the Wi-Fi access point manually

1 | Touch [ADD NETWORK].



2 | Input the SSID code.

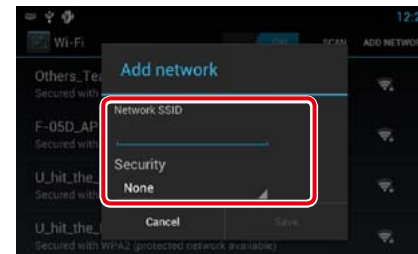

3 | Select the security.

4 | Input the security code.

5 | Touch [SAVE].

Confirm the MAC address

1 | Press the <MENU> button.

2 | Touch [Advanced].

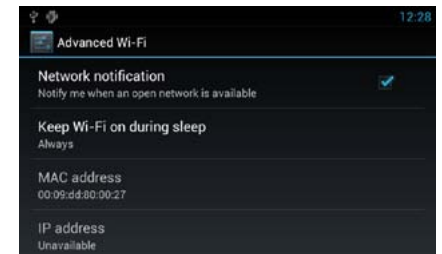
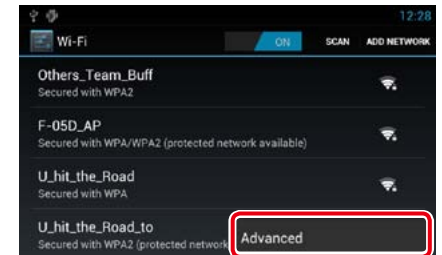

3 | Press the <↩> button.

Clock and Date Setup

Clock and Date Setup

1 | Press the <HOME> button to display the Home screen.

Note

- To display the Network contents panel, Press the <HOME> button again.

2 | Press the <MENU> button.

3 | Touch [Setting].



4 | Touch [Date & time].

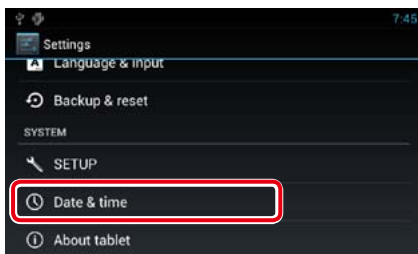

5 | Set each item as follows.

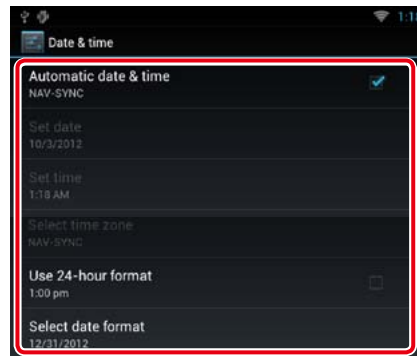

6 | Press the <↵> button.

Adjust the date and time manually.

1 | Touch [Automatic date & time] to remove the check

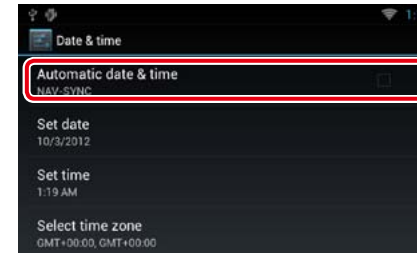

2 | Touch [Set date]

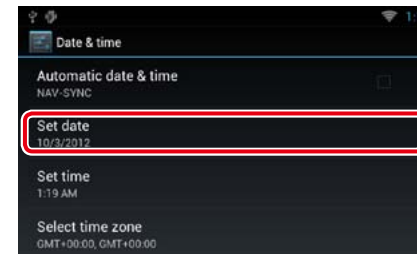

3 | Adjust the date.

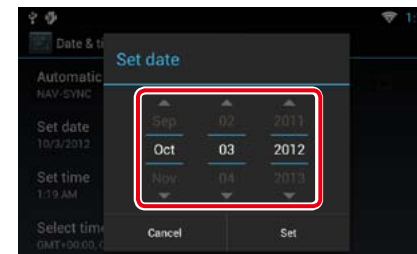

4 | Touch [Set]

5 | Touch [Set time]

6 | Adjust the time.

7 | Touch [Set]

8 | Touch [Select time zone].

9 | Select a time zone.

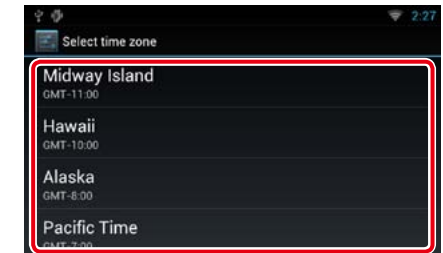

10 | Press the <↵> button.

Account Setup

About Account

To use this unit, you must register an account.

Types of accounts

You can create accounts to maintain privacy when using the mail feature or social media.

Administrator

As Administrator, you can create an owner account and perform initial setup.

You can log in to the system if you have not created an owner account.

Guest

An account for guests such as your friends.

The guest can operate this unit, but cannot use the functions related to mail, social media, and Route Collector site.

Owner

The account for the person who manages this unit.

The owner can use the functions related to mail, social media, and Route Collector site.

You can register users such as your family.

User

The account for the user of this unit.

The user can use the functions related to mail, social media, and Route Collector site.

You can register up to 4 user accounts.

Account registration procedure

1 | Create an account in the Route Collector site.

Create an account referring to [Create User Account \(P.32\)](#) or the Route Collector site.

<http://www.route-collector.com/>

2 | Register the account in this unit.

To register an Owner account, refer to [Set Owner Account \(P.33\)](#).

To register an User account, refer to [Set User Account \(P.34\)](#).

3 | Switch between login accounts.

See [Switch the User Login \(P.34\)](#).

Create User Account

To use this unit, you need to create an account in the Route Collector site.

Preparation

- To register yourself in the Route Collector site as a user, you need a mail address.
- You can register yourself via the Web.
<http://www.route-collector.com/>
- This step may be skipped if you have already registered yourself in the Route Collector site.

1 | Press the <HOME> button to display the Home screen.

2 | Press the <MENU> button.

3 | Touch [Account].



4 | Touch [Create Account].

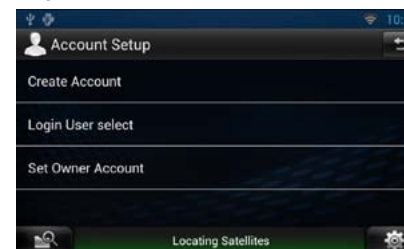

5 | Enter account information.



You cannot register an account which has already been used. Register another account name.

6 | Touch [OK].

The account is temporarily registered in the Route Collector site.

7 | Activate the account.

A confirmation mail is sent to the registered mail address. Open the indicated URL to complete account registration.

Set Owner Account

You can register an owner account for the person who manages this system.

Preparation

- First create an account in the Route Collector site. See [Create User Account \(P.32\)](#).
- If you have not created an owner account, log in to the system as Administrator.
- If you have created an owner account, log in to the system after account resetting.

1 | Press the <HOME> button to display the Home screen.

2 | Press the <MENU> button.

3 | Touch [Account].



4 | Touch [Set Owner Account].



5 | Enter account information.

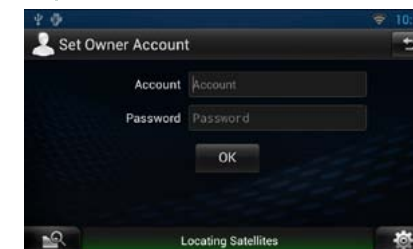

Enter the information registered in the Route Collector site.

6 | Touch [OK].

Set User Account

You can register a user account for the user of this navigation system.

Preparation

- First create an account in the Route Collector site. See [Create User Account \(P.32\)](#).
- You can set a user account when you have logged in the Owner.

- 1 | Press the <HOME> button to display the Home screen.
- 2 | Press the <MENU> button.
- 3 | Touch [Account].



- 4 | Touch [Set Account].



- 5 | Enter account information.

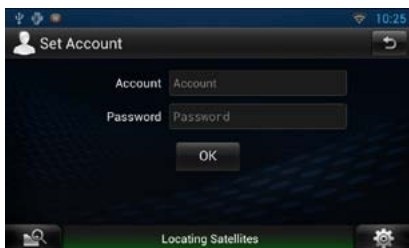

Enter the information registered in the Route Collector site.

- 6 | Touch [OK].

Switch the User Login

You can switch to a different account from the one currently logged in.

- 1 | Press the <HOME> button to display the Home screen.
- 2 | Press the <MENU> button.
- 3 | Touch [Account].



- 4 | Touch [Login User select].



- 5 | Select an account.



- 6 | Enter the password.



Delete User Account

You can delete a previously registered user account.

Preparation

- You can set a user account when you have logged in the Owner.

- 1 | Press the <HOME> button to display the Home screen.
- 2 | Press the <MENU> button.
- 3 | Touch [Account].



- 4 | Touch [Delete Account].

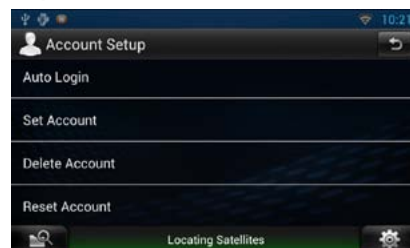

- 5 | Select an account.

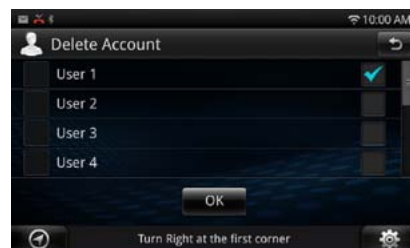

- 6 | Touch [OK].
Confirmation screen appears.

- 7 | Touch [Yes].

Reset Owner Account

You can delete previously registered owner and user accounts.

Preparation

- You can set a user account when you have logged in the Owner.

- 1 | Press the <HOME> button to display the Home screen.
- 2 | Press the <MENU> button.
- 3 | Touch [Account].



- 4 | Touch [Reset Account].

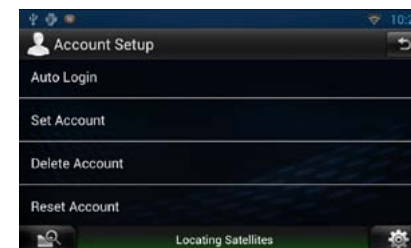

- 5 | Enter the owner account's password.



- 6 | Touch [OK].
Confirmation screen appears.

- 7 | Touch [Yes].

Note

- The data, log, and settings used in the account are deleted.

Widget and Application Operation

Weather Widget

Displays the weather forecast for the selected region.

Preparation

- You must have a connection with the internet using Wi-Fi. See [Wi-Fi Setup \(P.28\)](#).
- You can use this feature for 2 years after registration of the owner account. To use it continuously, a usage fee is required. For details, see web site of Route Collector.
<http://www.route-collector.com/>

- 1 | Press the <HOME> button.
- 2 | Select the Service panel.



1 Time & Date

Displays the current time and date.

2 Weather information

Displays the weather forecast for the selected region.

Touching this starts the weather application.

3 City information

Displays the selected region.

Touching this displays a region selection screen. See [City select \(P.36\)](#).

City select

- 1 | Touch [(City name)] in the Weather Widget.



1 City list

Displays a region list.

Touching this displays the selected region.

2 [Add City]

Starts the weather application to add the region. See [Add a City \(P.37\)](#).

Weather Application

Displays the weather forecast for the selected region.

Preparation

- You must have a connection with the internet using Wi-Fi. See [Wi-Fi Setup \(P.28\)](#).
- You can use this feature for 2 years after registration of the owner account. To use it continuously, a usage fee is required. For details, see web site of Route Collector.
<http://www.route-collector.com/>

- 1 | Press the <HOME> button.
- 2 | Touch [] in the Network contents panel.
- 3 | Touch [ Weather].

4 | Perform desired operation as follows.

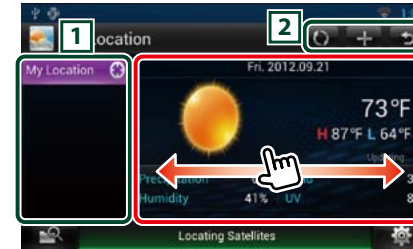



1 City list

Displays a region list.

Touching this displays the selected region.

2 Buttons

-  : Reads information again.
-  : Adds a region.
-  : Terminates the application.

(Weather information)

Displays the today's weather forecast and the weather forecast for the next 6 days.

Menu

- 1 | Press the <MENU> button.

Delete

Deletes a region from the City list. See [Delete City \(P.38\)](#).

Setting

Allows you to set the information update interval, etc. See [Weather setup \(P.38\)](#).

Add a City

Adds a region to the City list.

- 1 | Touch [].
- 2 | Search for a region.



(Voice recognition)

You can enter a region using the voice recognition function. When "Speak now" is displayed, pronounce the region name.

[Search]

Search starts.

- 3 | Select a region.

Touching the region adds it to the list, and displays the weather forecast.

Delete City

You can delete a region from the City list.

- 1 | Press the <MENU> button.
- 2 | Touch [Delete] in the Menu.
- 3 | Delete the region.

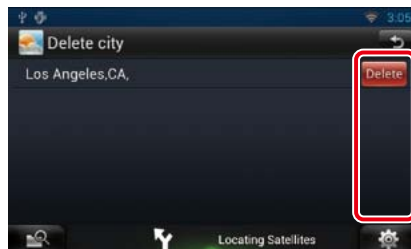

- 4 | Touch [Yes].
- 5 | Touch [↩].

Weather setup

Performs setup when using Weather Application.

- 1 | Press the <MENU> button.
- 2 | Touch [Setting] in the Menu.
- 3 | Select an option as follows.

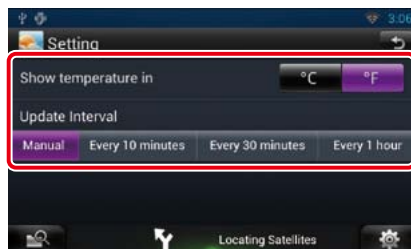

Show temperature

Select a temperature scale.

Update interval

Set an information update interval.

- 4 | Touch [↩].

Today Widget

You can display the today's schedule registered in Google Calendar.

Preparation

- To use this service, a Google account is required.
- You can use a user account when you have logged in the Owner or User.

- 1 | Press the <HOME> button.
- 2 | Select the Service panel.
- 3 | Touch [📅].
- 4 | Select the Today Widget.

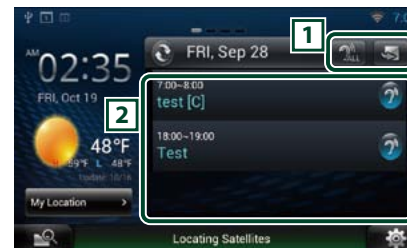

1 Buttons

- : Starts the schedule application.
- : Reads out all schedules in an auditory fashion.
- : Switches to RSS or SNS.

2 Schedule list

Displays the today's schedule registered in Google Calendar.

Touching it displays the event view.

- : Reads out the schedule in an auditory fashion.

SNS Widget

You can use Facebook, Twitter, Gmail, and email (IMAP).

Preparation

- To use each service, the email, Google, Facebook or Twitter account is required.
- You can use a user account when you have logged in the Owner or User.

- 1 | Press the <HOME> button.
- 2 | Select the Service panel.
- 3 | Touch [📧].
- 4 | Select the SNS Widget.



1 Buttons

- : Starts the SNS application.
- : Reads out all contents in an auditory fashion.
- : Switches to the schedule or RSS.

2 Category

Select a service category.

3 SNS article list

Displays the contents selected in Category in a new order.

Touching this starts the SNS application and displays its contents.

When the latest information is displayed at the top, sliding the list allows you to update the information.

- : Reads out the SNS contents in an auditory fashion.

RSS Widget

Displays the RSS news.

- 1 | Press the <HOME> button.
- 2 | Select the Service panel.
- 3 | Touch [RSS].
- 4 | Select the RSS Widget.



1 Buttons

- [Home]: Starts the RSS application.
- [RSS]: Reads out all the contents in an auditory fashion.
- [RSS Widget]: Switches to the schedule or SNS.

2 Category

Select a service category.

3 RSS article list

Displays the contents selected in Category in a new order.

Touching this starts the RSS application and displays its contents.

When the latest information is displayed at the top, sliding the list allows you to update the information.

- [RSS]: Reads out the RSS contents in an auditory fashion.

Schedule Application

You can edit schedules on the internet. In addition, you can also synchronize the schedule with Google Calendar.

Preparation

- You must have a connection with the internet using Wi-Fi. See [Wi-Fi Setup \(P.28\)](#).
- To use Google Calendar, a Google account is required.
- You can use a user account when you have logged in the Owner or User.

Register an account

Register account information for synchronization with the Google account.

- 1 | Press the <HOME> button.
- 2 | Touch [Schedule] in the Network contents panel.
- 3 | Touch [Schedule].
- 4 | Touch [Gmail].
- 5 | Input the Email address and Password.

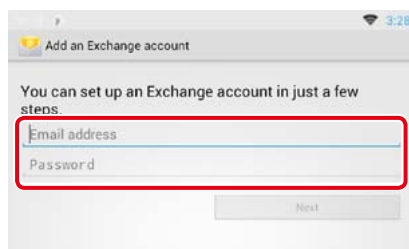

- 6 | Touch [Next].
- 7 | Change the server name to "m.google.com".

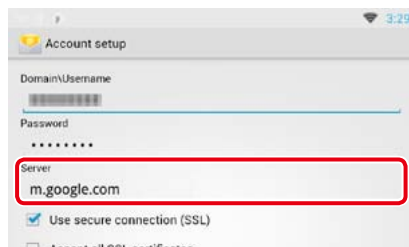

8 | Touch [Next] thrice.

Schedule Operation

- 1 | Press the <HOME> button.
- 2 | Touch [Schedule] in the Network contents panel.
- 3 | Touch [Schedule].
- 4 | Perform desired operation as follows.

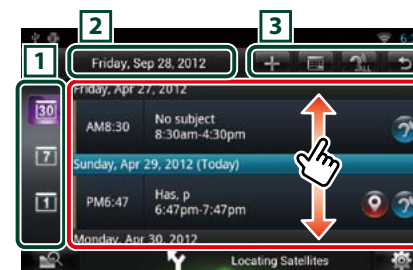

1 View category

- [30]: Displays agendas.
- [7]: Displays the weekly schedule.
- [1]: Displays the daily schedule.

2 Date information

Displays the date of the displayed schedule. Touching this displays the date of the schedule to be displayed.

3 Buttons

- [+]: Add a schedule.
- [Calendar Icon]: Displays the today's schedule.
- [RSS Icon]: Reads out all schedules by voice.
- [Stop Icon]: Terminates the application.

(Schedule list)

- Displays a schedule. Touching this displays details of the schedule.
- [RSS Icon]: Reads out the content of the schedule in an auditory fashion.

5 | Detailed schedule view.

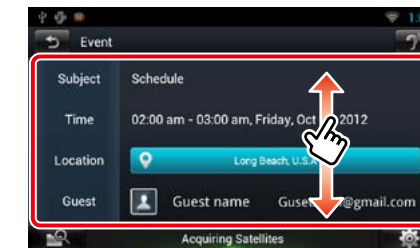

(Text-to-speech)

Reads out the content of the schedule by voice.

Menu

- 1 | Press the <MENU> button. Agenda view/ Week view/ Day view

Sign out

Logs out from the current account.

Event view

Edit event

Edit schedule.

Delete event

Deletes schedule.

When a confirmation screen appears, touch "Yes".

Add event

Adds an event to the schedule.

- 1 | Touch [**+**] in the Schedule application.
- 2 | Enter your schedule.

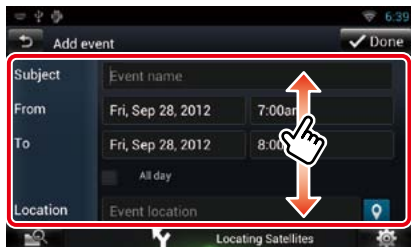

Enter an event name, date and time, description, etc.

- 3 | Add an event.



Synchronizes the schedule with Google Calendar if used.

Notification

Displays a notification icon in the message window and status bar when the set time is reached.

Message window

- 1 | Touch [View Event] to display event details.

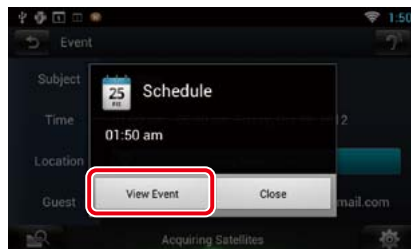

The Schedule application starts to display details.

Status bar

- 1 | Drag the status bar downward.

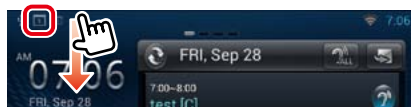

- 2 | Touch [**1**] to display details.

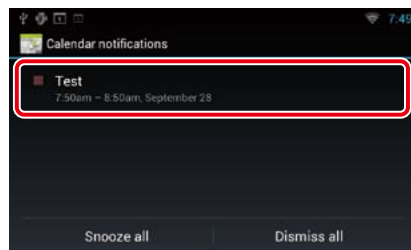

The Schedule application starts to display details.

SNS Application

Displays the screen for using Facebook, Twitter, and Gmail.

Preparation

- You must have a connection with the internet using Wi-Fi. See [Wi-Fi Setup \(P.28\)](#).
- To use a Google, Facebook or Twitter service, the corresponding account is required.
- You can use a user account when you have logged in the Owner or User.

Start the SNS Application

- 1 | Press the <HOME> button.
- 2 | Touch [**Grid**] in the Network contents panel.
- 3 | Touch [**SNS**].

Register an account

Facebook

- 1 | Touch [**Facebook**].
- 2 | Touch [Sign in].
- 3 | Input the Email address/Phone and Password.



- 4 | Touch [Log in].

Twitter

- 1 | Touch [Twitter].
- 2 | Touch [Sign in].
- 3 | Input the Username/email and Password.

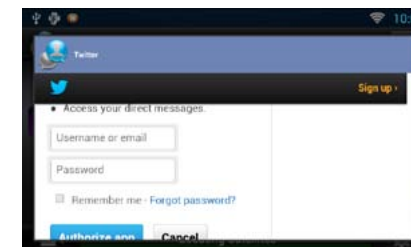

- 4 | Touch [Authorize app].

Gmail

- 1 | Touch [Gmail].
- 2 | Touch [Sign in].
- 3 | Touch [Gmail].
- 4 | Input the Email and Password.





- 5 | Touch [Next].

NOTE

- You can register Email (IMAP). Select [Other] in step 3, and enter necessary data according to the displayed messages.

SNS Operation

- 1 | Press the <HOME> button.
- 2 | Touch [] in the Network contents panel.
- 3 | Touch [ SNS].
- 4 | Perform desired operation as follows.



1 Buttons

- : Create a new article.
- : Posting the current place.
- : Reads out all articles by voice.
- : Terminates the application.

2 Category

Select a category to display.

3 Article list

Displays an article or message.

Touching this displays details.

While the latest information is displayed at the top, sliding the list down updates the information.

- : Reads out the article by voice.

5 | Detailed article or message view.

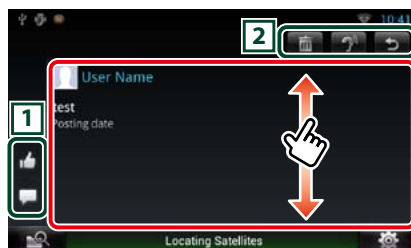

Facebook



1 Buttons

- : Votes as "Like".
- : Posts a comment.



2 Buttons

- : Deletes an article. When the confirmation screen appears, touch "Ok".
- : Reads the content of the comment by voice.

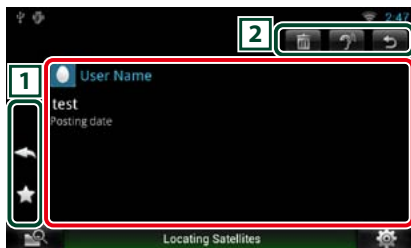

Twitter



1 Buttons

- : Create a reply.
- : Create a ReTweet.
- : Adds to Favorites.



2 Buttons

- : Delete the Tweet.
- : Reads the content of the comment by voice.

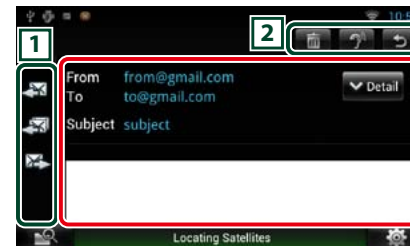

Gmail



1 Buttons

- : Creates a reply mail.
- : Creates a reply mail for all.
- : Creates a forwarded mail.

2 Buttons

- : Deletes an article. When the confirmation screen appears, touch "Ok".
- : Reads the content of the comment by voice.

Menu

- 1 | Press the <MENU> button.

Article list view

Setting

Set an update interval.

Sign out (Facebook, Twitter)

Logs out from the current account.

Account (Gmail)

Select the account and label to be displayed.

- ① Select an account.
- ② Select a label.

Add account (Gmail)

Register a new account.

Delete account (Gmail)

Delete a registered account.

Select the account to delete by putting a checkmark, and then touch [OK].

Add to post

Create an article to be posted to the SNS service of the selected category.

- 1 | Touch [] in the RSS application.
- 2 | Create an article to post.

Facebook

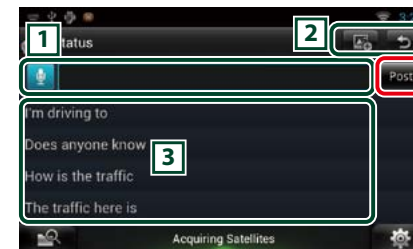

1

Enter an article to post.

- : Enter a comment using the voice recognition function. When "Speak now" appears, speak the comment.

[Post]: Posts the article.

2 Buttons

- : Post photo.

3

Select a fixed phrase.

Twitter



1

Enter an article to post.

: Enter a comment using the voice recognition function. When “Speak now” appears, speak the comment.

[Post]: Posts the article.

2 **Buttons**

: Post current location.

3

Select a fixed phrase.

Gmail

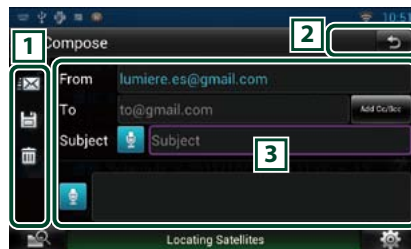

1 **Buttons**

- : Sends the mail.
- : Stores the mail temporarily.
- : Deletes the mail.

3

Create a mail message to send.

: Enter a comment using the voice recognition function. When “Speak now” appears, speak the comment.

[Add Cc/Bcc]: Displays cc and Bcc.

RSS Application

Displays an RSS feed.

Preparation

- You must have a connection with the internet using Wi-Fi. See [Wi-Fi Setup \(P.28\)](#).
- You can use a user account when you have logged in the Owner or User.

- 1 | Press the <HOME> button.
- 2 | Touch [] in the Network contents panel.
- 3 | Touch [] (RSS).
- 4 | Perform desired operation as follows.



1 **Buttons**

- : Adds an RSS feed. See [Add RSS feed \(P.47\)](#)
- : Reads out all articles by voice.
- : Terminates the application.

2 **Category**

Select the RSS feed to be displayed.

3 **Article list**

- Display the article.
- Touching this displays details.
- While the latest information is displayed at the top, sliding the list down updates the information.
- : Reads out the article by voice.

5 | Detailed article view.

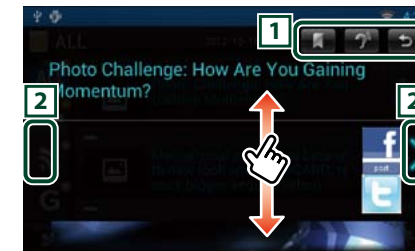

1 **Buttons**

: Registers the RSS feed in the bookmark. Deletes the RSS feed if it has already been registered.

: Reads the content by voice.

2

Moves to the previous or next article.

Menu

- 1 | Press the <MENU> button.
- Article list view

Delete

Delete an RSS feed. See [Delete RSS feed \(P.48\)](#)

Setting

Set the update interval. See [RSS setup \(P.48\)](#)

Add RSS feed

Add an RSS feed.

- 1 | Touch [] in the RSS application.
- 2 | Select a category.

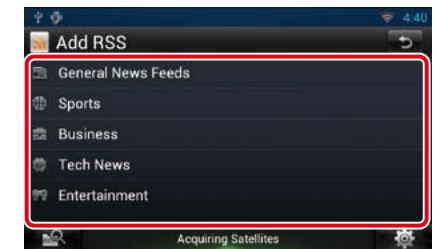

- 3 | Touch [Add].



Note

- In order to add an selectable RSS feed, you need to edit it in the Route Collector site. See www.route-collector.com/

Delete RSS feed

Delete an RSS feed.

1 | Press the <MENU> button.

2 | Touch [Delete].



3 | Touch [Yes] to confirm.

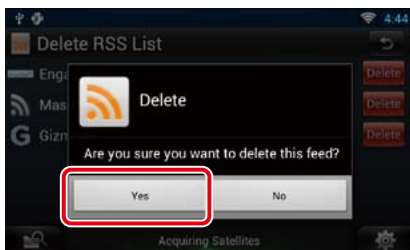

RSS setup

Performs setup when using RSS Application.

1 | Press the <MENU> button.

2 | Touch [Setting] in the Menu.

3 | Select an option as follows.

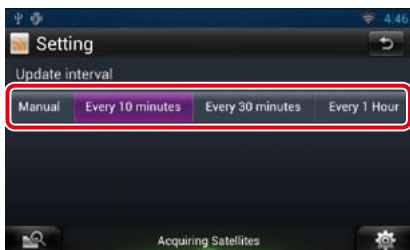

Update interval

Set the information update interval.

Now playing Widget

Displays the information about the song or station you are listening to, and allows you to perform simple operations.

1 | Press the <HOME> button.

2 | Select the Media panel.

Media source such as CD or USB

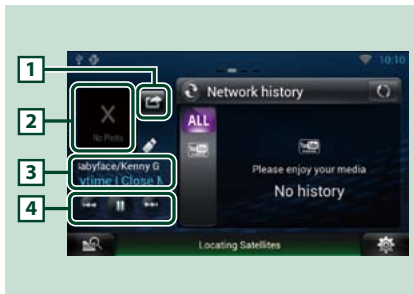

1 | [I'm listening]

You can post the information about the song you are listening to, on twitter, Facebook. See [Posting the information about the song you are listening to \(P.49\)](#).

2 | Album art

Touching Album art displays the Source control screen.

3 | Information display

Displays the information (title, etc.) about the song being played.

4 | Buttons

Allow you to stop playback temporarily and select songs.

Radio source such as Radio

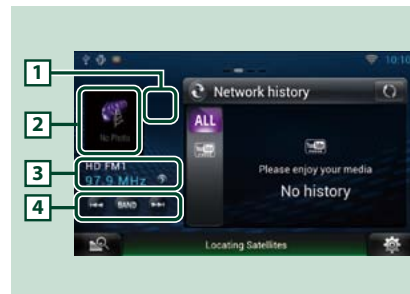

1 | [I'm listening]

You can post the information about the song you are listening to, on twitter, Facebook. See [Posting the information about the song you are listening to \(P.49\)](#).

2 | Artwork

Touching artwork displays the Source control screen.

3 | Information display

Displays the band, frequency, etc.

Touching this displays the Preset list screen. See [Preset select \(P.50\)](#).

4 | Buttons

Allows you to select a band and a station.

Posting the information about the song you are listening to

You can post the information about the song you are listening to, on Twitter, Facebook, or Route Collector site.

1 | Touch [I'm listening].

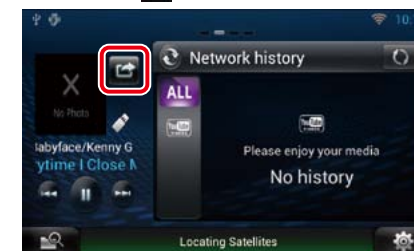

2 | Create the information you want to post.

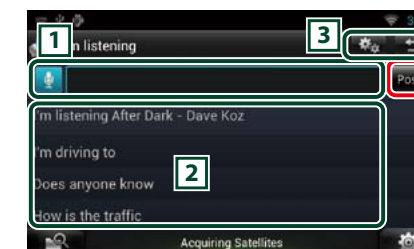

1

Enter the information you want to post.

[Voice icon] : Enter a comment using the voice recognition function. When "Speak now" is displayed, pronounce the comment.

[Post] : Posts the information.

2 | Fixed phrase

Select the information about the song you are listening to and a fixed phrase.

3 | [Settings icon]

Select the service on which you want to post the information.

Select the service, and then touch [OK].

Preset select

1 | Touch illustrated area.



2 | Select a station or channel from the list.

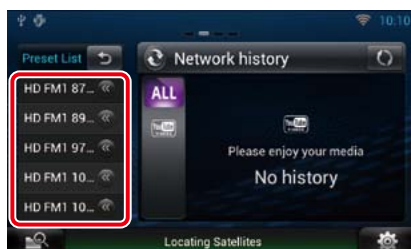

Network Media History Widget

You can select a song from the history of the songs played on YouTube, and listen to it again.

Preparation

- You must have a connection with the internet using Wi-Fi. See [Wi-Fi Setup \(P.28\)](#).
- You can use a user account when you have logged in the Owner or User.
- When the Trip log function is turned on, information about the played content is displayed.

- 1 | Press the <HOME> button.
- 2 | Select the Media panel.
- 3 | Touch [🔄].
- 4 | Select the Network media history Widget.
- 5 | Touch desired item.



1 Buttons

Update the history information.

🔄: Switches to Photo frame.

2 Category

Select the service category.

- 6 | Again, touch desired item.
Playback starts.

Photo Frame Widget

You can display the photos stored in the USB memory or SD card as a slide show.

- 1 | Press the <HOME> button.
- 2 | Select the Media panel.
- 3 | Touch [🖼️].
- 4 | Select the Photo Frame Widget.

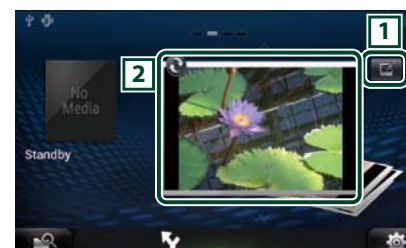

1 Edit

Edit the photo to be displayed.

2 Picture

Sliding the photo vertically scrolls through photos.

🖼️: Switches to Network media history.

Select the photo you want to display.

1 | Touch [🖼️].

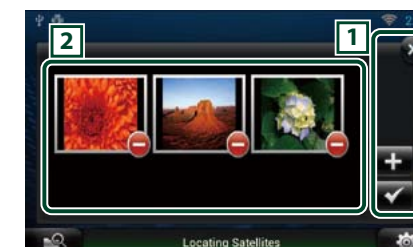

1 Buttons

⊕: Displays the screen for selecting the photo to be added.

✓: Ends editing, and returns to the Photo frame screen.

✕: Ends editing, and returns to the Photo frame screen

2 Thumbnail

Touch and hold the photo. When the photo shaking, drag the photo to change the order.

🗑️: Deletes the photo from the list.

2 | Touch [⊕].

3 | Select a picture.



4 | Touch [✓].

Mixed Media Search

You can search for a song in USB, SD, iPod, Kenwood Wireless Link, and Cloud Storage by entering an artist name or album name, and play the song irrespective of the media type.

1 | Touch [].

2 | Input the Artist or Album.

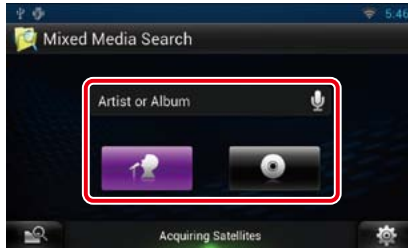

Enter the keyword using the voice recognition function. When "Speak now" is displayed, pronounce the keyword.

*You can use a user account when you have logged in the Owner or User.

Category

Determine whether to search for the song by artist name or album name.

3 | Select a song from the list.

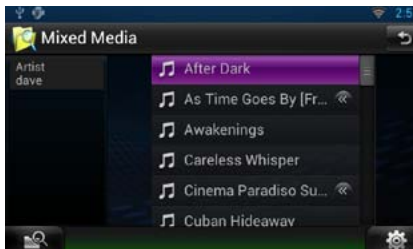

Playback starts.

Plays screen



Plays or pauses.



Searches the previous/next file.



Searches file.



Repeats the current file. Each time you touch the key, repeat mode switches on or off.

DVD/Video CD (VCD) Operation

DVD/VCD Basic Operation

Most functions can be controlled from the source control screen and playback screen.

NOTE

- Set the remote controller mode switch to DVD mode before starting operation, see [Switching the operation mode \(P.129\)](#).
- The screen shot below is for DVD. It may be different from the one for VCD.

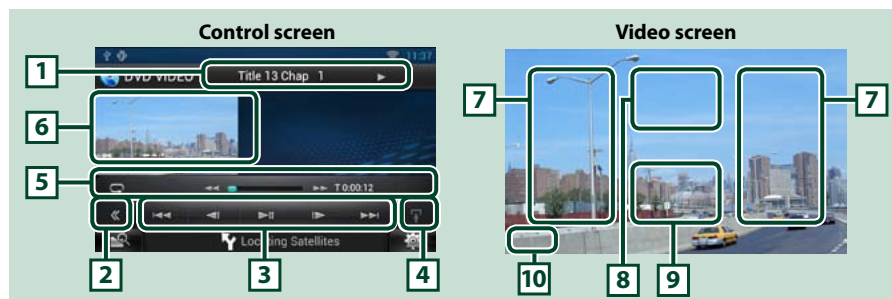

1 Information display

Displays the following information.

- Title #, Chap #:** DVD title and chapter number display
- Track #/Scene #:** VCD track or scene number display
*Scene # is displayed only when PBC is on.
- ▶, ▶▶, ▶▶▶, ■, etc.:** Current play mode display
The meanings of each icon are as follows; ▶ (play), ▶▶ (fast forward), ◀◀ (fast backward), ▶▶▶ (search up), ◀◀◀ (search down), ■ (stop), ■R (resume stop), || (pause), ▶ (slow playback), ◀ (slow reverse playback).

Touch this area to display the disc label name.

2 Multi function key

Touch to switch the multi function menu. For details on the menu, see [Multi function menu \(P.56\)](#).

3 Multi function menu

Various functions can be operated using keys in this menu. For details on the keys, see [Multi function menu \(P.56\)](#).

4 Control switching key

Unavailable in DVD/VCD source.

5 Sub function menu

The following functions can be performed by using keys in this area.

- Repeats the current content:** Touch [⏮]. Each time you touch the key, repeat mode switches in the following sequence:
 DVD: "title repeat" [🔁], "chapter repeat" [📄], "function off"
 VCD (PBC On): Does not repeat
 VCD (PBC Off): "track repeat" [🔁], "function off"
- Fast forward or fast backward:** Touch [⏮] or [⏭]. Each time you touch the key, the speed changes; standard, 2 times, 3 times.
- For confirmation of play time:** See ###.##.
 DVD: You can switch the time display between title play time, chapter play time, and title remaining time. Each time you touch, the display switches between "T ###.##" (title play time display), "C ###.##" (chapter play time display), and "R ###.##" (title remaining time display).
 As well as the time display, the bar indicating current location appears.
 VCD (PBC off): You can also confirm disc remaining time by touching time display. Each time you touch, the display switches between "P ###.##" (play time display) and "R ###.##" (disc remaining time).
- For confirmation of current playing position:**
 See the bar in center (DVD only). The bar does not appear while the remaining time is being displayed.

6 Movie display area

Touch to display Video screen.

7 Searching area

Touch to search the next/previous content.

Scrolling from center of display to left or right performs fast backward or fast forward. Each time you touch each area, the speed changes; standard, 2 times, 3 times. To stop fast backward/forward, touch center of the display.

8 Menu display area

This area functions differently depending on the current status.

- During DVD playback:** Displays the Movie control screen. During the menu display, displays the highlight control screen.
- During VCD playback:** Displays the Movie control screen. See [Zoom Control for DVD and VCD \(P.58\)](#).

9 Key display area

Touch to display the last control screen.

10 Screen setup display area

Touch and hold to display the screen control screen. See [Monitor Screen Setup \(P.108\)](#).

NOTE

- If you use a remote controller, you can jump directly to the desired video scene by entering the chapter number, scene number, play time, etc. [Direct search mode \(P.129\)](#).

Multi function menu

DVD



VCD



The functions of each key are as follows.

[<<] [>>]

Searches the previous/next content.

[▶||]

Plays or pauses.

[<|] or [|>] (DVD only)

Plays in slow motion forward or backward.

[■]

Stops playback. When touched twice, the disc is played from the beginning when you play it the next time.

[PBC] (VCD only)

Turn PBC on or off.

DVD Disc Menu Operation

You can set up some items in the DVD-VIDEO disc menu.

1 | Touch illustrated area during playback.



Movie control screen appears.

2 | Touch [Disc CTRL].



Menu Control screen appears.

3 | Perform desired operation as follows.



Displays the top menu

Touch [Top].*

Displays the menu

Touch [Menu].*

Displays the previous menu

Touch [Return].*

Enters selected item

Touch [Enter].

Enables direct operation

Touch [Highlight] to enter the highlight control mode. See [Highlight control \(P.57\)](#).

Moves the cursor

Touch [▲], [▼], [◀], [▶].

* These keys may not function depending on the disc.

Highlight control

Highlight control lets you control the DVD menu by touching the menu key directly on the screen.

1 | Touch [Highlight] in the Menu Control screen.

2 | Touch desired item on the screen.



NOTE

- The highlight control is cleared automatically if you do not operate for a constant time.

DVD Play Mode Setting

You can select DVD play mode.

- 1 | Touch [Next] in the Menu Control screen.



Menu Control 2 screen appears.

- 2 | Touch the key which corresponds to desired setting item.



Switches the subtitle language

Touch [Subtitle]. Each time you touch this key, language is switched.

Switches the audio language

Touch [Audio]. Each time you touch this key, language is switched.

Controls zoom ratio

Touch [Zoom]. For details, see [step 2 in Zoom Control for DVD and VCD \(P.58\)](#).

Switches the picture angle

Touch [Angle]. Each time you touch this key, picture angle is switched.

Exits menu control

Touch [Exit].

Displays the Menu Control 1 screen

Touch [Previous].

Zoom Control for DVD and VCD

You can enlarge Playback screen for DVD and VCD.

- 1 | For VCD, touch illustrated area during playback.



Movie control screen appears.

- 2 | Touch [Disc CTRL].



Zoom Control screen appears.

NOTE

- For DVD, please refer to [DVD Play Mode Setting \(P.58\)](#) to display the Zoom Control screen.

- 3 | Perform desired operation as follows.



Switches zoom ratio

Touch [Zoom].

For DVD, changes the zoom ratio at 4 levels; Off, 2 times, 3 times, 4 times.

For VCD, changes the zoom ratio at 2 levels; Off, 2 times.

Scrolls the screen

Touch [▲], [▼], [◀], or [▶] to scroll the screen in the direction you touch.

Exits menu control

Touch [Exit].

Displays the previous menu*

Touch [Return].

*This function may not be performed depending on the disc.

NOTE

- You cannot touch the menu keys directly on the screen when zooming.

DVD Setup

You can set up the DVD playback functions.

- 1 | Touch [Settings].

Quick menu appears.

- 2 | Touch [SETUP].

SETUP Menu screen appears.

- 3 | Touch [Source].



Source SETUP Menu screen appears.

- 4 | Touch [DVD SETUP] in the list.

DVD SETUP screen appears.

5 | Set each item as follows.



Menu/Subtitle/Audio Language*

See [Language setup \(P.60\)](#).

Dynamic Range Control*

Set the dynamic range.

Wide: The dynamic range is wide.

Normal: The dynamic range is normal.

Dialog (Default): Makes the total sound volume larger than other modes. This is effective only when you are using Dolby Digital software.

Angle Mark

Set an angle mark display.

ON (Default): An angle mark appears.

OFF: An angle mark does not appear.

Screen Ratio*

Set the screen display mode.

16:9 (Default): Displays wide pictures.

4:3 LB: Displays wide pictures in the Letter Box format (having black stripes at the top and bottom of screen).

4:3 PS: Displays wide pictures in the Pan & Scan format (showing pictures cut at the right and left ends).

Parental Level*

See [Parental level \(P.61\)](#).

DISC SETUP

See [Disc setup \(P.61\)](#).

Stream Information

Displays the present source information.
The stream (Dolby Digital, dts, Linear PCM, MPEG, WMA or AAC) appears.

*These items are disabled when a DVD is being played.

Language setup

This setting is for the language used in the menu, subtitle, and voice. You cannot setup these items during DVD playback.

- 1 | **Touch [SET] of the desired item; [Menu Language], [Subtitle Language], [Audio Language].**
Language Set screen appears.
- 2 | **Enter the desired language code and touch [Enter].**



Sets the entered language and returns to the DVD SETUP screen.

See [DVD Language Codes \(P.142\)](#).

NOTE

- To cancel the setup and return to the previous screen, touch [Cancel].
- To clear the entered code, touch [Clear].
- To set the DVD's original language for audio language, touch [Original].

Parental level

Set a parental lock level to prohibit children to watch video. You cannot set a parental lock level during DVD playback.

- 1 | **Touch [SET] of [Parental Level].**
Parental Pass screen appears.
- 2 | **Enter the parental code and touch [Enter].**
Parental Level screen appears.

NOTE

- To cancel the setup and return to the previous screen, touch [Cancel].
- To clear the entered code, touch [Clear].
- Current parental lock level appears as [Level#].

- 3 | **Touch [◀] or [▶] to select a parental lock level.**

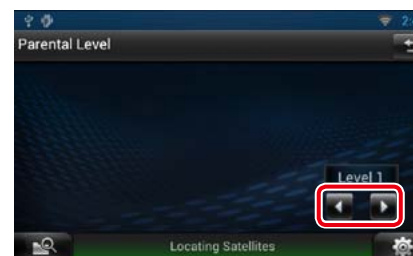

NOTE

- If a disc has higher parental lock level, you need to enter the code number.
- The parental lock level varies depending on a loaded disc.
- If a disc has no parental lock, anybody can play it even though you have set the parental lock.

Disc setup

Performs setup when using disc media.

- 1 | **Touch [SET] of [DISC SETUP].**
DISC SETUP screen appears.
- 2 | **Select an option as follows.**



CD Read

Set how this navigation system plays a music CD.

- 1 (Default): Automatically recognizes and plays an audio file on disc, a DVD or a music CD.
- 2: Forcibly plays a disc as a music CD. Select [2] if you wish to play a music CD having a special format or if you cannot play a disc with the option [1] set.

On Screen DVD

Set how this navigation system displays information on-screen.

Auto: When updated, information appears for 5 seconds.

OFF (Default): Information does not appear.

NOTE

- [CD Read] is disabled when a disc is already in the navigation system.
- You cannot play an audio file/VCD disc with the option [2] set. Also, you may not play some music CDs with the option [2] set.

CD/Audio and Visual Files/iPod Operation

Music/Video Basic Operation

Most functions can be controlled from the source control screen and playback screen.

NOTE

- Set the remote controller mode switch to AUD mode before starting operation, see [Switching the operation mode \(P.129\)](#).
- To connect iPod to this unit, optional accessory KCA-iP202 or KCA-iP102 is necessary. When iPod is connected using the KCA-iP202, you can listen to audio and watch video. When iPod is connected using the KCA-iP102, you can only listen to audio.

See the following sections for each source operation.

- **Music CD** [\(P.64\)](#)
- **Disc media** [\(P.62\)](#)
- **USB device** [\(P.64\)](#)
- **SD Card** [\(P.64\)](#)
- **iPod** [\(P.64\)](#)

Music CD and disc media

NOTE

- In this manual, "Music CD" will be referred to as the general CDs which include music tracks in. "Disc media" will be referred to as CD/DVD disc which includes audio, picture or video files.
- The screen shot below is for CD. It may be different from the one for disc media.



1 Information display

Displays the following information.

- **Track #:** Each time you touch this area, display switches between current track number, text, etc.
- **▶, ▶▶, ▶▶▶, ■, etc.:** Current play mode display
 The meanings of each icon are as follows; ▶ (play), ▶▶ (fast forward), ◀◀ (fast backward), ▶▶▶ (search up), ◀◀◀ (search down), ■ (stop), ■■ (resume stop), || (pause).

2 Movie display area/Control switching area

Touch to switch between the Simple Control and List Control screen. (Only for Music file)
 Touch to display Video screen. (Only for Video file)

3 Multi function key

Touch to switch the multi function menu. For details on the menu, see [Multi function menu \(P.66\)](#).

4 Multi function menu

Various functions can be performed by using keys in this area. For details on the menu, see [Multi function menu \(P.66\)](#).

5 Sub function key

Touch to display "Sub function menu" (7 in this table).

6 Track information

Displays the information of the current track.

For music CD and disc media, you can switch the current track information and the current folder list by touching the list switching key (8 in this table).

7 Sub function menu

Various functions can be performed by using keys in this area. For details on the keys, see [Sub function menu \(P.67\)](#).

8 Sub function/ List switching key

Touch to display "Sub function menu" (7 in this table).

Touch and hold to switch between the track list and the CD-TEXT display (CD)/ID3 tag information (disc media only).

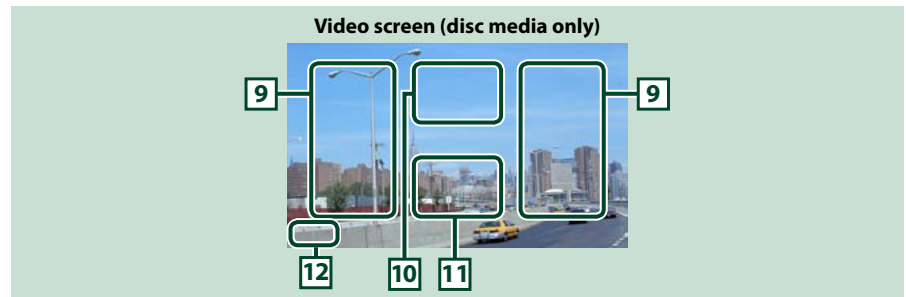

9 Searching file area (disc media only)

Touch to search the next/previous file.

Scrolling from center of display to left or right performs fast backward or fast forward. Each time you touch each area, the speed changes; standard, 2 times, 3 times. To stop fast backward/forward, touch center of the display.

10 Menu display area (disc media only)

Touch to display the Control screen. For details, see [Movie Control \(P.72\)](#).

11 Key display area (disc media only)

Touch to display the last control screen.

12 Screen setup display area

Touch and hold to display the screen control screen. See [Monitor Screen Setup \(P.108\)](#).

USB device, SD card and iPod

NOTE

- The screen shot below is for USB device. It may be different from the one for iPod and SD card.

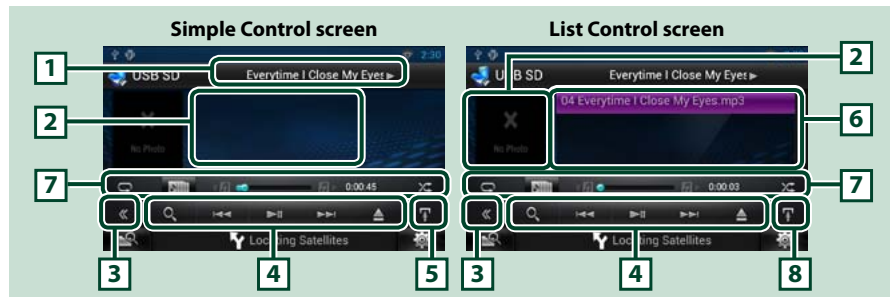

1 Information display

Displays the following information.

- Current file name:** Each time you touch this area, display switches between file number/folder number and file name.
- ▶, ▶▶, etc.: Current play mode display
 The meanings of each icon are as follows; ▶ (play, searching), || (pause), ▶▶ (forward manual search), ◀◀ (reverse manual search).

2 Artwork/Control switching area

Touch to switch between the Simple Control and List Control screen. (Only for Music file)
 Touch to display Video screen. (Only for Video file)

3 Multi function key

Touch to switch the multi function menu. For details on the menu, see [Multi function menu \(P.66\)](#).

4 Multi function menu

Various functions can be performed by using keys in this area. For details on the keys, see [Multi function menu \(P.66\)](#).

5 Sub function key

Touch to display "Sub function menu" (7 in this table).

6 Content list

Displays the list and content. The content of the list differ depending on the playback status and source.

7 Sub function menu

Various functions can be performed by using keys in this area. For details on the keys, see [Sub function menu \(P.67\)](#).

8 Sub function/ List switching key

Touch to display "Sub function menu" (7 in this table).
 Touch and hold to switch between the file list and the current file information.

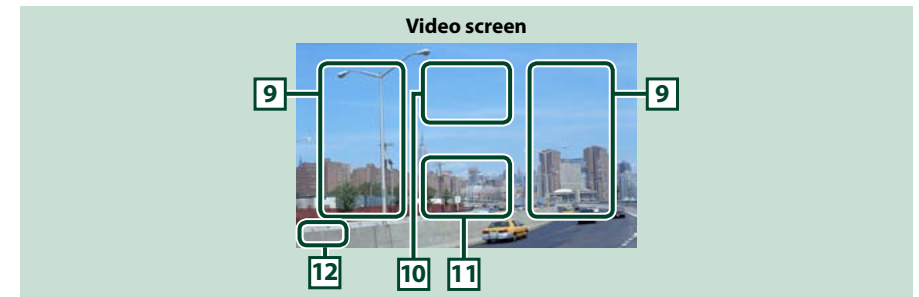

9 Searching file area (Video file only)

- Touch to search the next/previous file.
- During slide show in USB mode, touching each area searches the next/previous music file.
- Scrolling from center of display to left or right performs fast backward or fast forward. To stop fast backward/forward, touch center of the display. This function is not available when there is no music file in the current folder.

10 Movie control display area

Touch to display the Movie control screen. For details, see [Movie Control \(P.72\)](#).

11 Key display area (Video file only)

Touch to display the last control screen.

12 Screen setup display area

Touch and hold to display the screen control screen. See [Monitor Screen Setup \(P.108\)](#).

Multi function menu

Music CD



iPod



Disc media



USB device and SD card



The following functions can be performed by using keys in this area.

[] (Only for disc media, iPod, USB device, and SD card)

Searches track/file. For details on search operation, see [Search Operation \(P.68\)](#).

[] []

Searches the previous/next track/file.

[] [] (iPod only) / [] []

Plays or pauses.

[] (Only for music CD and disc media)

Stops playback.





[] (Only for iPod, USB device, and SD card)

Touch to disconnect the device. For details, see [How to Play Media \(P.18\)](#).

[] (Only for iPod)

Touch to switch among the App mode and Normal mode cyclically.

App mode: The navigation system outputs the audio and video sent from the application running on your iPod touch or iPhone.

In the App mode, you can control only the [] (play), [] (pause), [] (search down), and [] (search up) functions from this navigation system.

[] [] (Only for disc media, USB device, and SD card)

Searches previous/next folder.

Sub function menu

Music CD



iPod



Disc media



USB device and SD card



The following functions can be performed by using keys in this area.

[]

Repeats the current track/folder. Each time you touch the key, repeat mode switches in the following sequence;

CD, iPod: "track repeat"  "repeat off"

Disc media, USB device, SD card: "file repeat"  "folder repeat"  "repeat off"

[] (Only for iPod, USB device, and SD card)

Searches track from the album artwork list. For details on search operation, see [Search from album artwork \(P.70\)](#).

[] [] (Only for music CD and disc media)

Fast forward or fast backward.

[] [] (Only for iPod, USB device, and SD card)

Plays the previous or next album in [Favorite list \(P.71\)](#).

#:##:## or ##:##

For confirmation of play time.

During music CD playback, you can also confirm disc remaining time by touching time display.

Each time you touch, the display switches between "P #:##:##" (track play time display) and "R #:##:##" (disc remaining time).

[]

Randomly plays all tracks in current folder/disc or in current playlist in the connected iPod.

Each time you touch the key, random mode switches in the following sequence;

CD: "track random"  "random off"

Disc media, USB device, SD card: "file random"  "random off"

iPod: "track random"  "album random"  "random off"

Status bar in center (Only for iPod, USB device, and SD card)

For confirmation of current playing position.

During USB device and iPod playback, you can drag the circle left or right to change the playing position.

Search Operation

You can search music or video files by the following operations.

NOTE

- If you use a remote controller, you can jump directly to the desired track/file with entering the track/folder/file number, play time, etc. For details, see [Direct search mode \(P.129\)](#).

List search

You can search tracks, folders, and files according to hierarchy.

1 | Touch illustrated area.

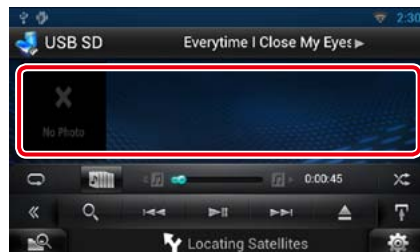

List Control screen appears.

2 | Touch desired track/file.



Playback starts.

NOTE

- For disc media, you can switch the file list and folder list by touching [Q].
- For disc media, you cannot display the list during random play and stop.

Other search

There are other search methods in order to narrow search for a song. This function is not available when music CD is the current source.

1 | Touch [Q] in the control screen.

The search type screen appears.

2 | Touch desired search method.

USB device and SD card

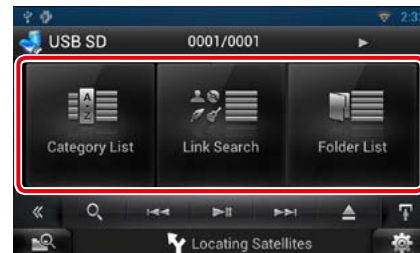

iPod

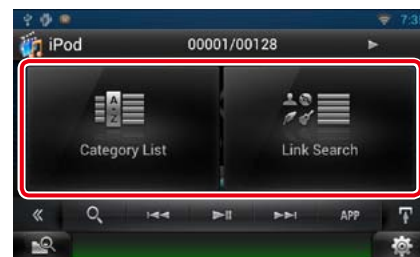

The list sorted in the way you selected appears.

See the following sections for each operation.

- [Category List]: You can search a file by selecting category [\(P.69\)](#).
- [Link Search]: You can search a file of same artist/album/genre/composer as the current track [\(P.69\)](#).
- [Folder List]: You can search a file according to hierarchy [\(P.70\)](#).

NOTE

- For disc media, you can display the folder list directly by touching [Q].

Category search (Only for iPod, USB device, and SD card)

1 | Touch the desired category from the left part of the screen.

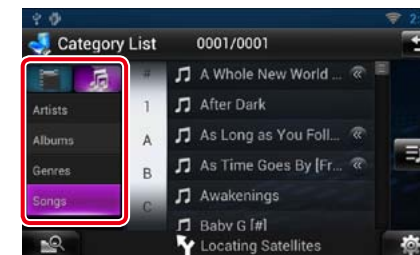

2 | The list is sorted by selected category.

3 | Touch desired song.

Playback starts.

NOTE

- To narrow the search you can select a letter from the alphabet list in the center of the display.
- For operations in the list screen, see [Common Operation \(P.24\)](#).

Link search (Only for iPod, USB device, and SD card)

1 | Touch the desired link from the left part of the screen. You can select from artist, album, genre and composer.

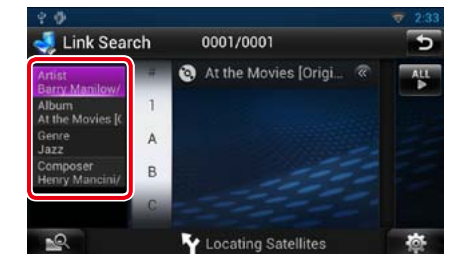

The link list corresponding to your selection appears.

NOTE

- The list is sorted by the way you selected.
 - Artist: Displays the album list of the artist.
 - Album: Displays all tunes of the current album.
 - Genre: Displays the artists list in which artists belong to the same genre.
 - Composer: Displays the album list of the composer of the current file.

2 | Touch to select desired item in the list. Repeat this step until you find the desired file.

NOTE

- To narrow the search you can select a letter from the alphabet list in the center of the display.
- For operations in the list screen, see [Common Operation \(P.24\)](#).

Folder search (Only for disc media, USB device, and SD card)

1 | Touch the desired folder.



Content of the folder are displayed in the right area of the screen.

2 | Touch desired item from the content list.

Playback starts.

NOTE

- For operations in the list screen, see [Common Operation \(P.24\)](#).

Search from album artwork (Only for iPod, USB device, and SD card)

You can search music files by selecting the album artwork.

1 | Touch [].

Sub function menu appears.

2 | Touch [].

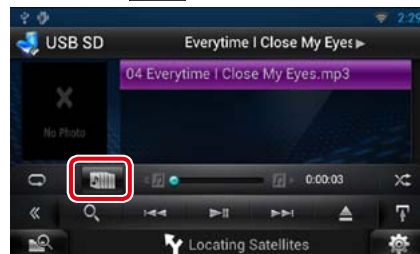

Favorite screen appears.

3 | Touch desired artwork in the upper line.



NOTE

- The key in the upper side of the screen functions differently depending on the status.
 - When [Load Albums] appears:
You have not yet loaded any artwork. Touch the key to start loading.
 - When [Load More Albums] appears:
Some artwork are not loaded. Touch the key to load all artwork. If you touch the key, the track being played may stop and another track may start playback.
 - When the key does not available:
All artwork are already loaded.

4 | Touch [] on the selected artwork.

The first song in the album is played.

In addition, you can create your original playlist from this screen. For details, see [Favorite list \(P.71\)](#).

NOTE

- After all tracks in the album are played, the same album is played again from the first track.
- The albums with no photo are not displayed.

Favorite list

You can create an original playlist of your favorite 10 albums by selecting album artworks.

1 | Touch and drag the desired album artwork in the upper line to the lower line.

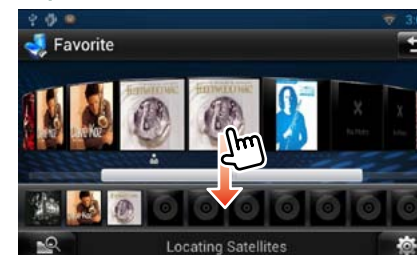

Selected album is registered to the favorite list.

NOTE

- The added album is placed on farthest right.
- You cannot register the same album already registered to the favorite list.
- Up to 10 albums can be registered to the list.

2 | Touch the desired artwork in the favorite list.



The selected album is played and the control screen appears.

NOTE

- The favorite list is played to the right starting with the selected album.
- To delete the album from the favorite list, touch and drag it to the upper line.
- You can change the playing order of the favorite list by dragging the artwork in the list.
- The favorite list mode is canceled in the following situations.
 - Playing another album from other list (folder list, category list, etc.)
 - Playing another album by touching the artwork in the upper line in the artwork list screen.
- The favorite list mode resumes after disconnecting/connecting the device or turning on/off. File being played, playing time code, favorite list content, favorite list order, etc. resumes if file configuration of the device is not changed.

Movie Control

You can adjust the movie playback.

- 1 | In the playback screen, touch illustrated area.



Movie control screen appears.

- 2 | Touch [DISC CTRL]. (Disc media only)



Movie Control screen appears.

- 3 | Perform desired operation as follows.



Changes subtitle language

Touch [Subtitles].

Changes audio language

Touch [Audio].

Exits the menu

Touch [Exit].

USB/SD/iPod/DivX Setup

You can perform setup when using USB/SD/iPod/DivX.

- 1 | Touch [Settings].
Quick menu appears.

- 2 | Touch [SETUP].
SETUP Menu screen appears.

- 3 | Touch [Source].



Source SETUP Menu screen appears.

- 4 | Touch [USB], [iPod] or [DivX] in the list.

Each setup screen appears.

See the following section for each setting.

- [USB SD setup \(P.73\)](#)
- [iPod setup \(P.73\)](#)
- [DivX® VOD \(P.73\)](#)

USB SD setup

- 1 | Set each item as follows.



On Screen USB SD

Set how information from a USB device or SD is displayed.

Auto (Default): Information appears for 5 seconds when updated.

OFF: Does not display any information.

iPod setup

- 1 | Set each item as follows.

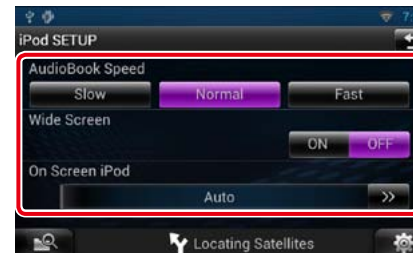

AudioBook Speed

Set the audio book playback speed. Select from [Slow], [Normal] (default), and [Fast].

Wide Screen*

Set Wide Screen. Set [ON] (default) or [OFF].

On Screen iPod

Set how to display the information of the iPod.

Auto (Default): Information appears for 5 seconds when updated.

OFF: Does not display any information.

* This setting is not available when an iPod is connected.

DivX® VOD

- 1 | Set each item as follows.



DivX(R) Registration Code

Checks the registration code. This code is needed when making a disc which has DRM (Digital Rights Management).

DivX(R) Deactivation

Deregisters the unit which is already registered. After you touch the key, a confirmation message appears. Follow the message and complete the operation.

NOTE

- [DivX(R) Registration Code] is disabled when a DVD is being played.
- When downloading a DivX VOD file controlled by DRM, register the code appeared on the screen. Otherwise the file may not be able to play with this navigation system. Remaining number of viewing is displayed when playing a DivX VOD file with the viewing restriction. When the remaining number of viewing reached 0, a warning message appears and the file cannot be played.

Cloud Storage Operation

Starting procedure

Make preparations for allowing this unit to play the music files uploaded to Dropbox.

Preparation

- You must have a connection with the internet using Wi-Fi. See [Wi-Fi Setup \(P.28\)](#).
- You can use a user account when you have logged in the Owner or User.
- To use this service, a Dropbox account is required.

1 | Upload music files to Dropbox.

2 | In the Route Collector site, create a folder and playlist of the files to be played.

For how to set the folder and playlist of the files to be played, refer to the website.

<http://www.route-collector.com/>

Available content

Content that can be delivered or played by this unit are as follows:

- Audio file: MP3 (.mp3), AAC-LC (.m4a/ .aac), WMA (.wma), WAV (.wav)
- Copyrighted content cannot be played.

Music Basic Operation

The music files uploaded to Dropbox can be played.

Preparation

- To play the files uploaded to Dropbox, setting is required. See [Starting procedure \(P.74\)](#).

1 | Press the <HOME> button.

2 | Touch [] in the Source launcher panel.

3 | Touch [Storage].

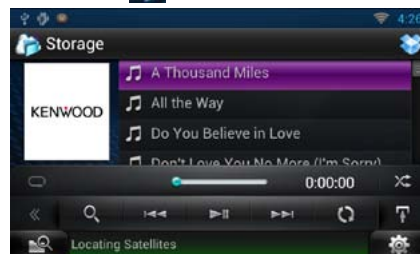

Plays or pauses.



Searches the previous/next file.



Searches file. For details on search operation, see [Category search \(P.75\)](#).



Repeats the current file. Each time you touch the key, repeat mode switches on or off.



Randomly plays all files in current folder or in current playlist.

Each time you touch the key, random mode switches in the following sequence;

"file random" , "random off"



For confirmation of play time.

Status bar in center

For confirmation of current playing position. You can drag the circle left or right to change the playing position.

Category search

You can search music files by the following operations.

1 | Touch [] in the control screen.

The search type screen appears.

2 | Touch the desired category from the left part of the screen.

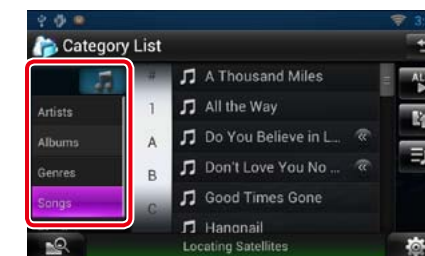

3 | The list is sorted by selected category.

4 | Touch desired music file.

Playback starts.

NOTE

- To narrow the search you can select a letter from the alphabet list in the center of the display.
- For operations in the list screen, see [Common Operation \(P.24\)](#).

Kenwood Wireless Link Operation

Starting procedure

By using the Wi-Fi function, media files can be shared with another media server device or client (player) device.

Preparation

- Turn on the function of Wi-Fi connection to a media server device or client device. See [Wi-Fi Setup \(P.28\)](#).

Media Server function

Plays the content stored in the USB memory or SD card connected to this unit via another network media player (client device).

- We confirmed normal operation using the following network media players (software):
- Windows Media Player 12

Media Player function

Plays the content stored in another media server device via this unit.

- We confirmed normal operation using the following media servers (software):
- Windows Media Player 12

Media Controller function

Allows you to handle the content stored in another media server device via this unit and play them on another network media player (client device).

Media Renderer function

Plays the content being operated on another media controller through this unit.



Available content

Content that can be delivered or played by this unit are as follows:

- Audio file: MP3 (.mp3), AAC-LC (.m4a/ .aac), WMA (.wma), WAV (.wav)
- Video file: MPEG-1/2 (.mpg/ .mpeg/ .m2p), MPEG-4 (.mp4/ .m4v), WMV (.wmv/ .m2ts)
- Copyrighted content cannot be played.

Media Server function

Plays the content stored in the USB memory or SD card connected to this unit via another network media player (client device).

- 1 | Press the <HOME> button.
- 2 | Touch [] in the Source launcher panel.
- 3 | Touch [ Wireless Link].
- 4 | Touch [DMS].

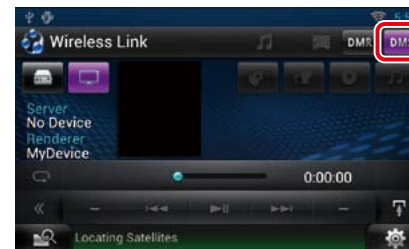



The server function is turned on.

- 5 | Connect from the client device.
Operate the client device to connect to the server.
Server name: DNN9230DAB.

Media Player function

Plays the content stored in another media server device via this unit.

- 1 | Press the <HOME> button.
- 2 | Touch [] in the Source launcher panel.
- 3 | Touch [ Wireless Link].
- 4 | Connect to the media server.

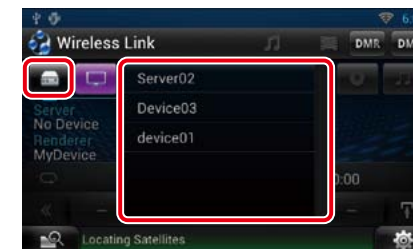

A list of detected media servers is displayed.

Touch the server name of the server to connect.

- 5 | Select the content to play.

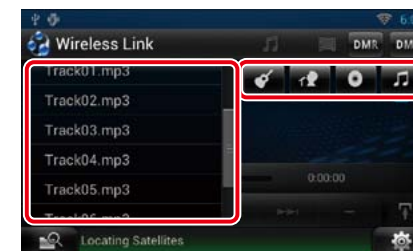

Select the category of the content to play.
A list of detected content is displayed.

Plays screen



[▶||]

Plays or pauses.

[◀◀▶▶]

Searches the previous/next file.

[🔄]

Repeats the current file. Each time you touch the key, repeat mode switches on or off.

[🎵📺]

Switches between music and video files.

##:##:## or ##:##

For confirmation of play time.

Status bar in center

For confirmation of current playing position. You can drag the circle left or right to change the playing position.

Media Controller function

Allows you to handle the content stored in another media server device via this unit and play them on another network media player (client device).

- 1 | Press the <HOME> button.
- 2 | Touch [📺] in the Source launcher panel.
- 3 | Touch [🌐 Wireless Link].
- 4 | Connect to the media server.



A list of detected media servers is displayed.

Touch the server name of the server to connect.

- 5 | Select a network media player to be used for playback.

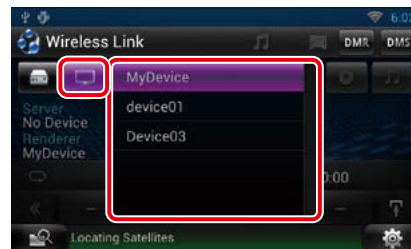

A list of detected network media players is displayed.

Touch the name of the network media player to be used for playback.

Media Renderer function

Plays the content being operated on another media controller through this unit.

- 1 | Press the <HOME> button.
- 2 | Touch [📺] in the Source launcher panel.
- 3 | Touch [🌐 Wireless Link].
- 4 | Touch [DMR].



The Rendering function is turned on.

- 5 | Establish connection from the media controller.
 Operate the media controller to connect to this unit.
 This unit: DNN9230DAB.

Radio Operation

Radio Basic Operation

Most functions can be controlled from the source control screen.

NOTE

- Set the remote controller mode switch to AUD mode before starting operation, see [Switching the operation mode \(P.129\)](#).

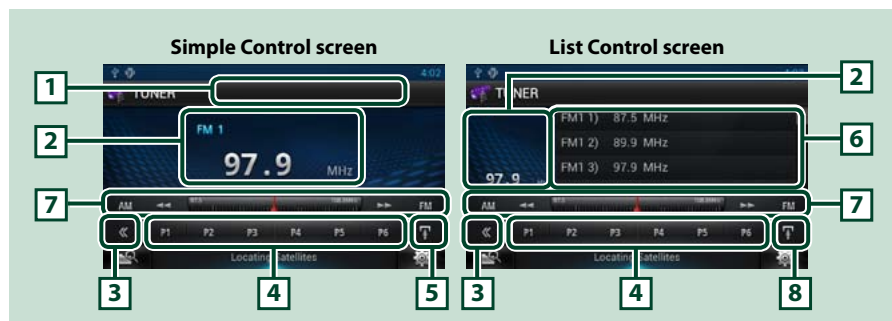

1 PS/Station name display

Displays the PS name.

2 Information display/Control switching area

Displays the following information.

- [FM1] etc.: Band display
- MHz/kHz: Frequency display
- Preset #: Preset number

Touch to switch between the Simple Control and List Control screen.

3 Multi function key

Touch to switch the multi function menu. For details on the menu, see [Multi function menu \(P.81\)](#).

4 Preset key/Multi function menu

Recalls the memorized station or channel. When touched for 2 seconds, stores the current receiving station or channel in memory.

When switched, various functions can be performed by using keys in this area.

For details on the menu, see [Multi function menu \(P.81\)](#).

5 Sub function key

Touch to display "Sub function menu" (7 in this table).

6 Preset list

Displays the list of preset stations and the information.

7 Sub function menu

The following functions can be performed by using keys in this area.

- Switches the band: Touch [AM] or [FM].
- Tunes in a station: Touch [◀◀] [▶▶]. The method of frequency switching can be changed. See Seek mode.
- The bar in center (tuner only) shows the current frequency location.

8 Sub function/ List switching key

Touch to display "Sub function menu" (7 in this table).

Touch and hold to switch between the preset list and the information list.

In tuner mode, tuned program information will be displayed.

Multi function menu

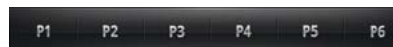

The functions of each key are as follows.

[P1] - [P6]

Select the preset station. Touch for 2 seconds to store the current station into the preset memory.

[Q]

Displays the list of preset stations or services. For details, see [Selecting Operation \(P.84\)](#).

[TI] (FM Tuner only)

Sets the traffic information mode on. For details, see [Traffic Information \(P.86\)](#).

[SEEK]

Switches the seek mode in the following sequence; [AUTO1], [AUTO2], [MANUAL].

- AUTO1: Tunes in a station with good reception automatically.
- AUTO2: Tunes in stations in memory one after another.
- MANUAL: Switches to the next frequency manually.

[AME]

Selects the auto memory mode. For details, see [Auto memory \(P.84\)](#).

[PTY] (FM Tuner only)

Searches a program by setting program type. For details, see [Search by program type \(P.85\)](#).

[MONO] (FM Tuner only)

Select the Monaural reception.

[LO.S] (FM Tuner only)

Turns the Local Seek function on or off.

Digital Radio Basic Operation

Most functions can be controlled from the source control screen.

NOTE

- Set the remote controller mode switch to AUD mode before starting operation, see [Switching the operation mode \(P.129\)](#).

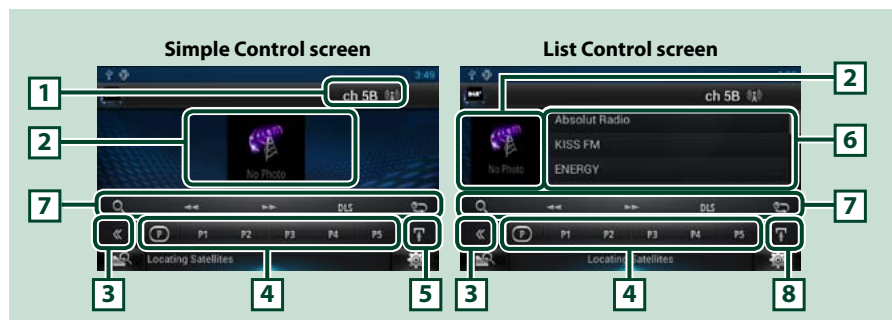

1 Signal Strength indication/Channel display

Displays the received signal strength of the Digital Radio station.
Displays the received channel number display.

2 Artwork/Control switching area

The picture data is displayed if available from current content.
Touch to switch between the Simple Control and List Control screen.

3 Multi function key

Touch to switch the multi function menu. For details on the menu, see [Multi function menu \(P.83\)](#).

4 Preset key/Multi function menu

Recalls the memorized station or channel. When touched for 2 seconds, stores the current receiving station or channel in memory.
When switched, various functions can be performed by using keys in this area.
For details on the menu, see [Multi function menu \(P.83\)](#).

5 Sub function key

Touch to display "Sub function menu" (7 in this table).

6 Information list

Displays information about the current music being played: Channel Name, Artist Name, Song Title, Content Info, Category Name, Channel Description, Similar Channels

7 Sub function menu

The following functions can be performed by using keys in this area.

- Display the list type screen: Touch [Q]. See [Selecting Operation \(P.84\)](#).
- Tunes in a ensemble, service, and component:
Touch [◀▶]. The method of ensemble, service, and component switching can be changed. See [Replay \(P.86\)](#).
- Display the Dynamic Label Segment screen: Touch [DLS].
- Change the Replay mode: Touch [C].

8 Sub function/ List switching key

Touch to display "Sub function menu" (7 in this table).
Touch and hold to switch between the preset list and the information list.

Multi function menu

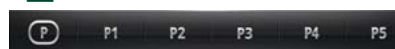

The functions of each key are as follows.

[P]

Switches the preset number.

[P1] - [P5]/ [P6] - [P10]/ [P11] - [P15]

Select the preset channel. Touch for 2 seconds to store the current station into the preset memory.

[SEEK]

Switches the seek mode in the following sequence; [AUTO1], [AUTO2], [MANUAL].

- AUTO1: Tunes in a ensemble with good reception automatically.
- AUTO2: Tunes in ensemble in memory one after another.
- MANUAL: Switches to the next ensemble manually.

[TI]

Sets the traffic information mode on. For details, see [Traffic Information \(P.86\)](#).

[PTY]

Searches a program by setting program type. For details, see [Search by program type \(P.85\)](#).

Memory Operation

Auto memory



You can automatically store stations with good reception to memory. This function is for radio only.

NOTE

- Auto memory terminates when 6 stations are stored or when all stations are tuned in.
- Auto memory ends automatically if you do not operate within 10 seconds.

- 1 | Touch [].
Sub function menu appears.
- 2 | Touch desired band key.



- 3 | Touch [] in the control screen.
The multi function menu appears.
- 4 | Touch [AME] in the multi function menu.
- 5 | Touch [] or [] in the sub function menu.
Auto memory starts.

Manual memory

You can store the current receiving station or channel in memory.

- 1 | Select a station or channel you wish to store in memory.
- 2 | Touch [P#] (#:1-6, 1-15) in which you want to store the station for 2 seconds until a beep sounds.

Selecting Operation

Preset select

You can list and select memorized station or channel.

Selecting from the multi function menu

- 1 | Touch the desired number from P1 to P6/ P15.
The navigation system will tune to the selected station or channel.

Selecting from the preset list

- 1 | Touch illustrated area.



List Control screen appears.

- 2 | Touch and hold [].
Preset list appears.
- 3 | Select a station or channel from the list.



NOTE

- Touching [] and then [Preset List] displays the preset channel list. You can also select your desired channel from the list.

Search by program type

You can tune to a station with a specific program type when listening to FM or DAB.



- 1 | Touch [] in the control screen.
The multi function menu appears.
- 2 | Touch [PTY] in the multi function menu.
PTY Mode screen appears.
- 3 | Select a program type from the list.
- 4 | Touch [Search].



You can search a station of the selected program type.

List select

You can select an ensemble from a list of memorized ensembles or select a service from a list of all services received.

- 1 | Touch [] in the control screen.
The multi function menu appears.
- 2 | Touch [] in the multi function menu.
The list type screen appears.
- 3 | Touch [Preset List] or [Service List].



List screen appears.

- 4 | Select the desired content from the list.

Traffic Information

You can listen and watch the traffic information automatically when a traffic bulletin starts.

However, this feature requires a Radio Broadcast Data System that includes the TI information.

- 1 | Touch [] in the control screen.
The multi function menu appears.
- 2 | Touch [TI] in the multi function menu.
Traffic information mode is set.

When the traffic bulletin starts

The Traffic Information screen appears automatically.



NOTE

- It is necessary to have Traffic Information function set to on in order to have the Traffic Information screen appear automatically.
- The volume setting during reception of traffic information is automatically stored. The next time the traffic information is received, this unit recalls the volume setting automatically.

Replay (Digital Radio only)

You can replay the last 30 minutes of current station.

- 1 | Touch [] in the sub function menu.



Multi function menu

- [▶||] Plays or pauses.
- [◀◀] [▶▶] Forward/backward 15 seconds when touch it.
- [◀◀] [▶▶] Fast forward/fast backward when keep on touching.

Sub function menu

Replay time bar

Confirms the current location.

- [] Change the Live mode

NOTE

- PTY Watch starts operating and Replay function cannot be used while receiving a program.
- While replaying the current station, you can not store the station by [Auto memory \(P.84\)](#) and [Manual memory \(P.84\)](#).

Tuner Setup

You can set tuner related parameters.

- 1 | Touch [].
Quick menu appears.
- 2 | Touch [SETUP].
SETUP Menu screen appears.
- 3 | Touch [Source].



Source SETUP Menu screen appears.

- 4 | Touch [TUNER SETUP] in the list.
TUNER SETUP screen appears.
- 5 | Set each item as follows.



NEWS

Sets a news bulletin interrupt time. Default is "OFF".

AF

When station reception is poor, automatically switches to the station that is broadcasting the same program over the same Radio Data System network. Default is "ON".

Regional

Sets whether to switch to the station only in the specific region using the "AF" control. Default is "ON".

Auto TP Seek

When traffic information station reception is poor, automatically searches for a station that can be received better. Default is "ON".

Language Select

Selects a display language for the PTY function.

DAB Setup

You can set Digital Radio related parameters.

- 1 | Touch [].
Quick menu appears.
- 2 | Touch [SETUP].
SETUP Menu screen appears.
- 3 | Touch [Source].



Source SETUP Menu screen appears.

- 4 | Touch [DAB SETUP] in the list.
DAB SETUP screen appears.
- 5 | Set each item as follows.



Priority

If the same service is provided by Digital Radio during Radio Data System reception, automatically switches to Digital Radio. If the same service is provided by Radio Data System when reception of the service being provided by Digital Radio becomes poor, automatically switches to Radio Data System.

PTY Watch

If the service of the set program type begins with the ensemble being received, switches from any source to Digital Radio for service reception.

Announcement Select

Switches to the set Announcement service. For details, see [Announcement setup \(P.89\)](#).

Seamless Band

Prevents audio break when switching from Digital Radio to Analog Radio. Default is "ON".

Antenna Power*

Sets power supply to the Digital Radio antenna. Set to "ON" when the Digital Radio antenna in use is equipped with a booster. Default is "ON".

L-Band Tuning*

Sets L-band reception. When set to "ON", also receives L-band ensembles.

* This item can be set when in STANDBY source.

Announcement setup

When the service for which ON is selected starts, switches from any source to Announcement to receive it.

- 1 | Touch [SET] of [Announcement Select] in the DAB SETUP screen.
The Announcement Select screen appears.
- 2 | Touch each Announcement list and set on or off.



NOTE

- The volume setting during reception of Announcement service is automatically stored. The next time the Announcement service is received, this unit recalls the volume setting automatically.

Streaming Service Application

Streaming Video Application

You can play videos uploaded to YouTube.

Preparation

- You need to connect to Internet using Wi-Fi. See [Wi-Fi Setup \(P.28\)](#).

- 1 | Press the <HOME> button.
- 2 | Touch [] in the Network contents panel.
- 3 | Touch [ Streaming Video].

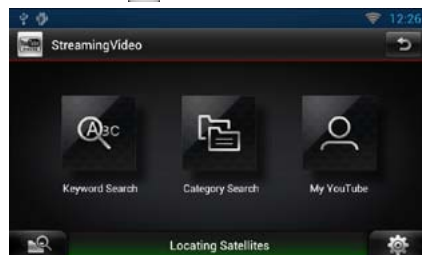

[Keyword Search]

Searches for videos associated by the keyword.

[Category Search]

Searches for videos by the category.

[My YouTube]

When you log in to YouTube, you can use the following:

My Favorites, My-Video, Registered Channels, Playlist

Video screen

- 1 | In the playback screen, touch illustrated area.



Control screen appears.

- 2 | Perform desired operation as follows.

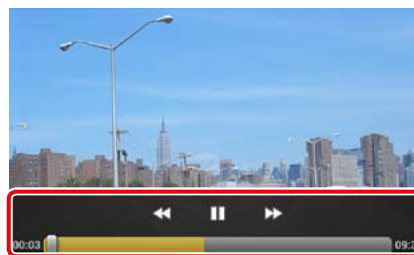

[<<] [>>]

Fast forward or fast backward.

[||] [▶]

Plays or pauses.

Status bar

For confirmation of current playing position. You can drag the circle left or right to change the playing position.

Keyword Search

- 1 | Touch [Keyword Search].
- 2 | Perform desired operation as follows.

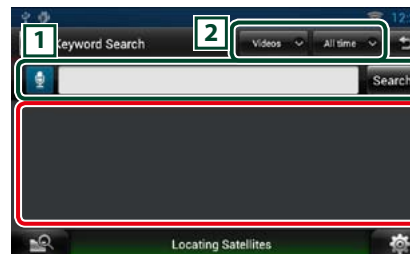

1

Enter a Keyword for search.

 : Enter a keyword using the voice recognition function. When "Speak now" is displayed, pronounce the keyword.

[Search] : Begins search.

2

Specify the search range.

Menu

- 1 | Press the <MENU> button.

[Sign in]

Log into the YouTube service.

Now you can use My YouTube.

[Sign out]

Log out from the current account.

My YouTube

By logging into YouTube, you can use My Favorites and My-Videos.

- 1 | Press the <MENU> button.
- 2 | Touch [Sign in].
- 3 | Input the Email address and Password.



- 4 | Touch [Sign in].

- 5 | Touch [Grant access].

- 6 | Touch [My YouTube].

- 7 | Select a category.

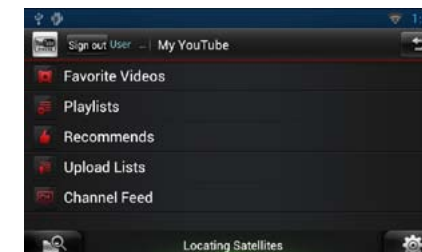



AUPEO! Application

You can listen to music on the online radio AUPEO!.

Preparation

- You need to connect to Internet using Wi-Fi. See [Wi-Fi Setup \(P.28\)](#).

- 1 | Press the <HOME> button.
- 2 | Touch [] in the Network contents panel.
- 3 | Touch [ Aupeo!].
- 4 | Select a genre.

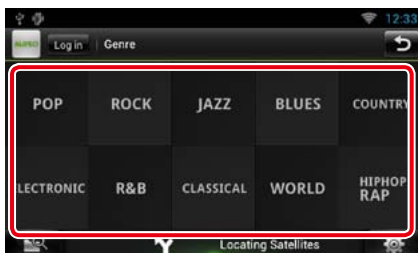

Log in

By registering an account, you can listen to your favorite songs.

- 1 | Touch [Log in].
- 2 | Input the User Name and Password.

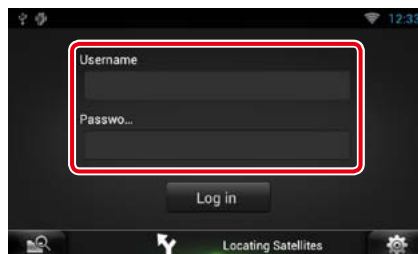

- 3 | Touch [Log in].

Play screen

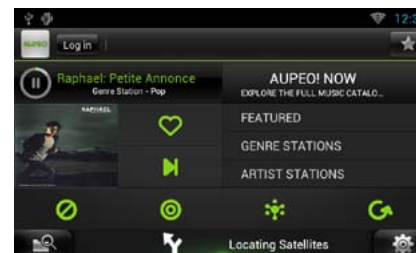

Plays or pauses.



I like this song.



Play the next song.



I do not like this song.



Select a sub genre.



Music matching your mood.



Select a new genre.



Select a Featured Stations



Select a Genre Stations



Create a station of your type by searching stations by the artist name.

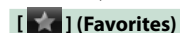

Edit the titles registered in Loves and Bans. You can use this button only when you have logged in to this service.

Editing Favorites

You can edit the titles registered in Loves and Bans.

Preparation

- You can only use this function when you have logged in this service.

- 1 | Touch [].



Switches between Love and Ban.



Deletes this title.



Registers this artist as Ban.

Bluetooth Control

Using the Bluetooth function, various functions can be used: listening to the audio file, making/receiving a call.

About the Smartphone/cell-phone and Bluetooth audio player

This navigation system conforms to the following Bluetooth specifications:

Version

Bluetooth Ver4.0 Certified

Profile

Smartphone/cell-phone:

HFP (Hands Free Profile)

OPP (Object Push Profile)

PBAP (Phonebook Access Profile)

SPP (Serial Port Profile)

Audio player:

A2DP (Advanced Audio Distribution Profile)

AVRCP (Audio/Video Remote Control Profile)

NOTE

- For the smartphones/cell-phones verified for compatibility, access the following URL: <http://www.kenwood.com/cs/ce/bt/>.
- The navigation systems supporting the Bluetooth function have been certified for conformity with the Bluetooth Standard following the procedure prescribed by Bluetooth SIG. However, it may be impossible for such navigation systems to communicate with your smartphone/cell-phone depending on its type.

Registering and Connecting Bluetooth Unit

It is necessary to register the Bluetooth audio player or smartphone/cell-phone to this unit before using the Bluetooth function.

You can register up to 5 Bluetooth units.

1 | Press and hold the < > button.



Hands Free screen appears.

2 | Touch [Settings].

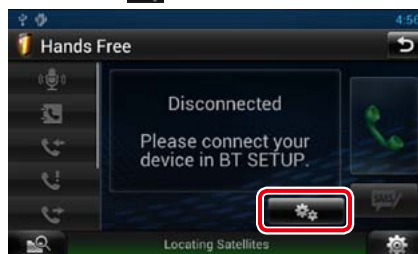

Bluetooth SETUP screen appears.

See the following section for each setting.

- **Registering the Bluetooth Unit** (P.95)
- **Connecting the Bluetooth unit** (P.96)

Registering the Bluetooth Unit

1 | Touch [Search].

Searched Device List screen appears.

NOTE

- A new device cannot be registered if there are 5 registered Bluetooth units. Delete unnecessary registration. See [Connecting the Bluetooth unit](#) (P.96).
- The Searched Device List screen cannot be displayed, when the receiving source is Pandora internet radio or Bluetooth Audio.
- This navigation system is compatible with the Apple Easy Pairing function. When an iPod touch or iPhone is connected to this navigation system using Dock Connector to USB Cable, an authentication dialog appears. Performing operation for authentication on this navigation system or iOS smartphone registers the smartphone as a Bluetooth device.

2 | Touch [PIN Code Set].

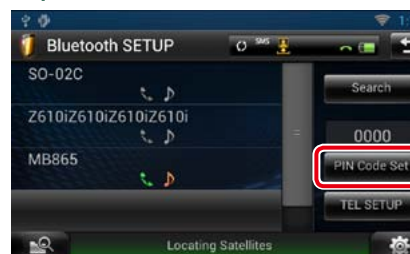

PIN Code Set screen appears.

NOTE

- If the Bluetooth unit cannot be searched in step 1, you can search it again by touching [Search] in above screen.
- Touch [Cancel] to cancel searching for the Bluetooth unit.

3 | Enter PIN code and touch [Enter].

The entered code is recognized and Searched Device List screen appears again.

NOTE

- If you want to cancel the registration, touch [Cancel].
- If you want to clear the entered number, touch [Clear].

4 | Select the Bluetooth unit to register from the list.

The Connection Device List screen appears.

NOTE

- You can also register the Bluetooth unit such as smartphone by operating it. In this operation, entering the PIN code is necessary. See step 2 to 3.

Connecting the Bluetooth unit

- 1 | **Touch the name of device to connect.**
 Profile select screen appears.

NOTE

- If the icon of selected Bluetooth unit is lit, it indicates that the navigation system will use that Bluetooth unit.

- 2 | **Set each profile as follows.**

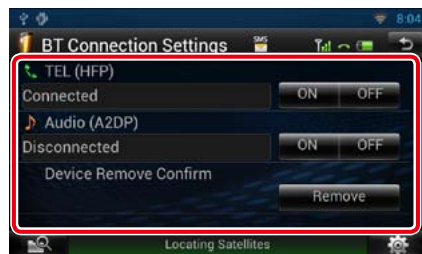

TEL (HFP)

Means that the Bluetooth unit is a smartphone/cell-phone.

Audio (A2DP)

Means that the Bluetooth unit is an audio player or smartphone/cell-phone with audio player.

NOTE

- TEL (HFP) setting for the previously connected Bluetooth phone is automatically OFF when you connect another Bluetooth phone. However it is not automatically OFF for some Bluetooth phone and you cannot connect a newly connected Bluetooth phone even you set ON for TEL (HFP). In this case, set TEL (HFP) OFF manually for the previously connected Bluetooth phone.
- Touching [Remove] of [Device Remove Confirm] removes registration information. After you touch the key, a confirmation message appears. Follow the message and complete the operation.

Playing Bluetooth Audio Device

Bluetooth basic operation

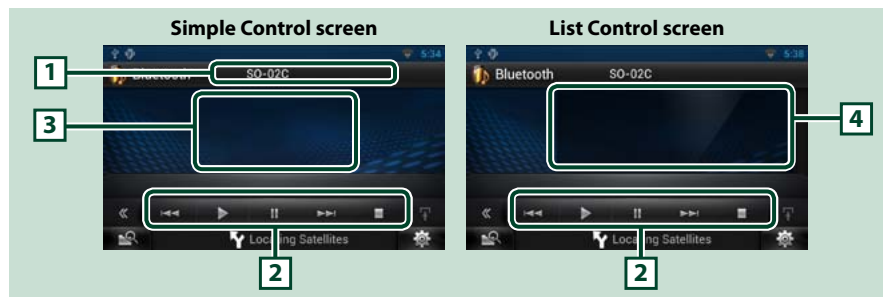

1 Information display

Displays the name of the track information. If the information is not available, Bluetooth unit name is displayed.

2 Multi function menu

The functions of each key are as follows.

- [◀◀] [▶▶]: Searches the previous/next content.*
- [▶]: Plays.*
- [⏸]: Pauses.*
- [■]: Stops playback.

3 Control switching area

Touch to switch between the Simple Control and List Control screen.

4 File information

Displays the information of the current file.

***These items appear only when the audio player which supports AVRCP profile is connected.**

NOTE

- If the operation keys do not appear, operate from the player.
- Depending on your smartphone/cell-phone or audio player, audio may be heard and controlled but text information may not appear.
- If the volume is too low, raise it on your smartphone/cell-phone or audio player.
- Speakers from which audio is output change depending on the Bluetooth setting "Bluetooth HF/Audio". The default is Front only. See [Hands-Free Setup \(P.102\)](#).

Using Hands-Free Feature

You can make or answer a call with Hand-Free by connecting a smartphone/cell-phone with built-in Bluetooth connected to this navigation system.

Downloading the phonebook

If you want to use your phonebook data, download the data from your smartphone/cell-phone to this navigation system in advance.

- 1 Operate your smartphone/cell-phone to send the phonebook data to this navigation system.
- 2 Operate the cell-phone to start the hands-free connection.

NOTE

- If your cell-phone supports auto-download of phonebook but not downloaded automatically, follow the procedure above to download manually.
- See the instruction manual of your cell-phone for the operation.
- Up to 600 phone numbers can be registered for each registered cell-phone.
- Up to 32 digits can be registered for each phone number along with up to 50 characters representing a name. (50 is the number of alphabetical characters. Fewer characters can be input depending on the type of characters.)
- Depending on the type of your cell-phone, the following restrictions are placed;
 - The phonebook data cannot be downloaded normally.
 - Characters in the phonebook are garbled.
- To cancel downloading the phonebook data, operate the cell-phone.

Making a call

- 1 Press and hold the < > button.



Hands Free screen appears.

- 2 Select a dialing method.

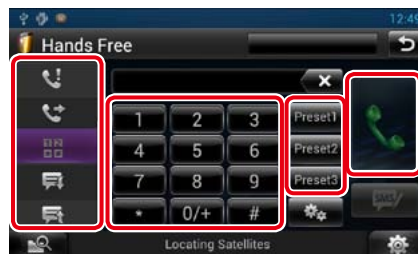

See the following table for each method.

Call by entering a phone number

- 1 Touch [].
- 2 Enter a phone number with number keys.
- 3 Touch [].

Call using call records

- 1 Touch [] (Incoming Calls), [] (Outgoing Calls), or [] (Missed Calls).
- 2 Select the phone number from the list.
- 3 Touch [].

Call using the phonebook

- 1 Touch [].
- 2 Select the name from the list.*1*2
- 3 Select the number from the list.
- 4 Touch [].

Call using the preset number

- 1 Touch [Preset #] to start calling the corresponding phone number.

Voice Recognition

You can access the voice recognition function of the smartphone/cell-phone connected to this navigation system.

You can search a phone number in the smartphone/cell-phone phonebook by pronouncing a name. (The functionality depends on the cell-phone.)

- 1 Touch [] to Voice Recognition screen appears.
- 2 Pronounce a name.

*1 You can sort the list to begin with touched character.



- Characters with no corresponding name will not appear.
- During search, a non-accent character such as "u" is searched for instead of an accent character such as "ü".

*2 You can set the list to arrange in the order of last name or first name. For details, see [Hands-Free Setup \(P.102\)](#).

NOTE

- While your car is moving, some functions are disabled for safety reasons. The keys associated with the disabled functions become ineffective if touched.
- The status icons such as battery and antenna displayed may differ from those displayed on the cell-phone.
- Setting the cell-phone in the private mode can disable the hands-free function.

Voice Recognition

You can access the voice recognition function of the smartphone/cell-phone connected to this navigation system.

You can search a phone number in the smartphone/cell-phone phonebook by pronouncing a name. (The functionality depends on the cell-phone.)

1 | Press the <MENU> button.

NOTE

- This function is not displayed in the menu when you are operating an application. Press the <HOME> button to use this function.

2 | Touch [Voice].

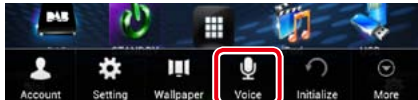

Voice Recognition screen appears.

3 | Pronounce a name.

Answering a call

1 | Touch [] to answer a call or [] to reject a call.



NOTE

- While monitoring the camera view, this screen does not appear even if a call comes in. To display this screen, press the <TEL> button or return the shift knob of car to the driver position.

Operation during a call

Adjust the receiver volume

Press the <▼> or <▲> button.

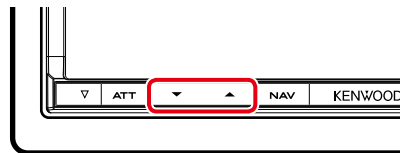

Switch the voice output

Touch [] to switch the voice output between phone and speaker.

Sending DTMF tone signal

Touch [DTMF] to display the tone input screen. You can send tones by touching desired keys on the screen.

Call waiting

You can answer a second call while talking with the first caller by placing the first call on hold and

switching to the second call. You can switch back and forth between first and second caller as well.

To answer the second call

Touch []. The first call is placed on hold and answers the second waiting call.

To switch back and forth between the first and second caller

Touch [] again.

Each time you touch [], the caller is switched.

To terminate the first call

Touch [].

The caller switches to the second caller.

Phone number preset

You can register frequently used phone numbers to this unit.

1 | Enter the number you want to register in Hands Free screen.



2 | Touch [Preset 1], [Preset 2], or [Preset 3] for 2 seconds in the Hands Free screen.

Hands-Free Setup

You can perform various setup about hands-free function.

1 | Touch [] on any screen.

2 | Touch [SETUP].
 SETUP Menu screen appears.

3 | Touch [Bluetooth].

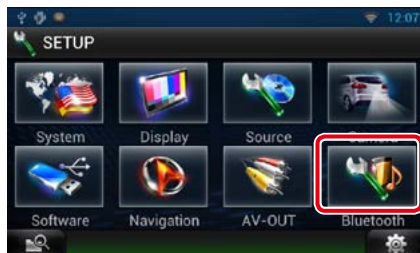

Bluetooth SETUP screen appears.

4 | Touch [TEL SETUP].

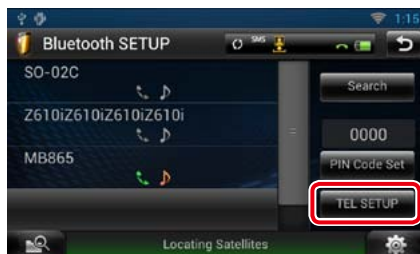

Hands-free SETUP screen appears.

5 | Set each item as follows.



Bluetooth HF/Audio

Select the speakers to output the sound from cell-phone (such as phone call voice and ringing tone) and Bluetooth audio player.

Front Only (Default): Outputs from the front speakers.

All: Outputs from all speakers.

Auto Response*1

Set the ringing time interval until the system automatically answers a call.

OFF (Default): Automatic response is not available.

0-99: Set ringing time interval (second).

Auto Pairing

When set to "ON", the Apple Auto Pairing function is turned on to automatically register the iPod touch or iPhone connected to this unit.

ON (Default): Uses Apple Auto Pairing function.

OFF: Not uses Apple Auto Pairing function.

Call Beep

Select whether or not to beep upon receiving a call.

ON (Default): Beeps.

OFF: Not beeps.

SMS Receive Beep

Select whether or not to beep upon receiving SMS message.

ON (Default): Beeps.

OFF: Not beeps.

Phone Information Use

Set whether to download phonebook for outgoing, incoming and missed calls list.

ON (Default): Yes.

OFF: No.

SMS Use

Select whether to use SMS.

ON (Default): Uses SMS.

OFF: Not uses SMS.

Sort Order

Set how to arrange the cell-phone phonebook.

First: Arranges in the order of first name.

Last (Default): Arranges in the order of last name.

Echo Cancel Level

Adjust the level of echo cancellation.

Default is "0".

Microphone Level

Adjust the sensitivity of the telephone microphone.

Default is "20".

Noise Reduction Level

Reduces the noises generated by surrounding environment without changing the microphone volume. Use this setting when the voice of caller is not clear. Default is "0".

[Restore]

Resets the settings to the default settings.

***1 Either the time interval for automatic answer set on this navigation system or the time interval set on your smartphone/cell-phone, whichever is shorter takes effect.**

SMS (Short Message Service)

You can send or receive a short message using SMS function on this navigation system.

- 1 | **Press and hold the < > button.**
Hands Free screen appears.
- 2 | **Touch [SMS] or [SMS] in the Hands Free screen.**



- 3 | **Select a SMS message to read from the Received or Sent SMS messages list.**

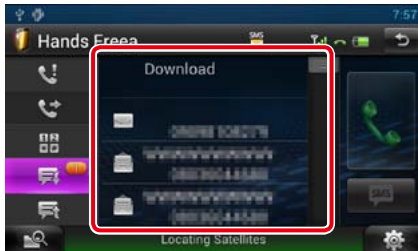

The selected SMS message appears.



Indicates the number of unread SMS messages.



Indicates the number of read SMS messages.

NOTE

- When there is an unread SMS message(s), unread SMS message is indicated in [SMS] (number)..

Creating an SMS (Short Message Service)

- 1 | **Touch [SMS], [SMS], [SMS], [SMS], [SMS], or [SMS] in the Hands Free screen.**
The phone numbers list appears.
- 2 | **From the phone numbers list, select a phone number to send a SMS.**

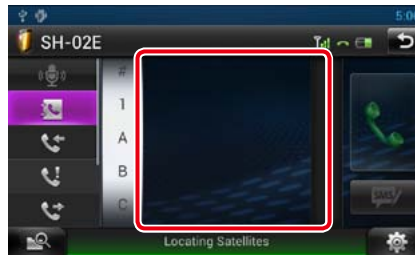

- 3 | **Touch [SMS].**

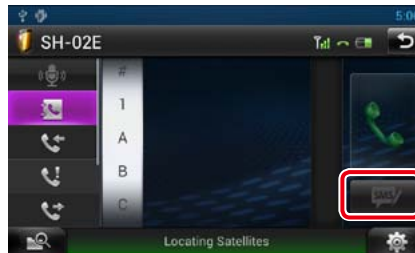

SMS Create Menu screen appears.

- 4 | **Touch [SET] of [Message] in the SMS Create Menu screen.**

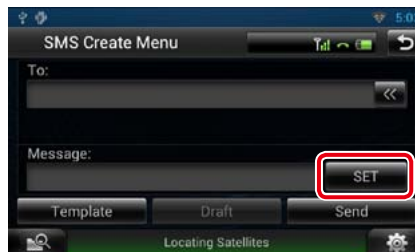

Create SMS Message screen appears.

[Template]

Displays the template list.

[Draft]

Displays the newest draft message. This key becomes active when any message has been created after turning power on.

- 5 | **Enter a message using keys and touch [Done].**

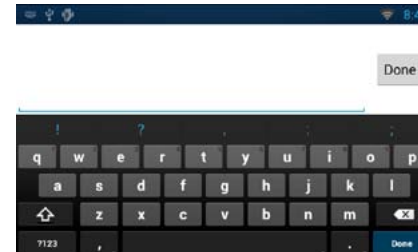

- 6 | **Touch [Send].**

The message is sent.

NOTE

- You can create a SMS message by directly entering a phone number and a short message on the Hands Free screen.
- [Delete] appears only when a draft message is being edited. Touching [Delete] deletes the message. After you touch [Delete], a confirmation message appears. Follow the message and complete the operation.

Using templates

You can create a message easily by selecting the desired sentence from the template list.

- 1 | **Touch [SMS] in the Hands Free screen.**
SMS Create Menu screen appears.
- 2 | **Touch [Template].**

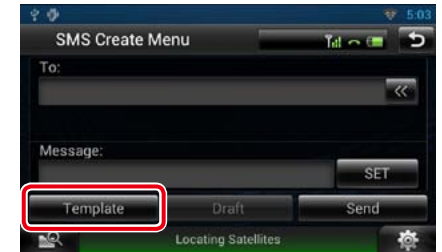

Template list screen appears.

- 3 | **Touch the desired template.**

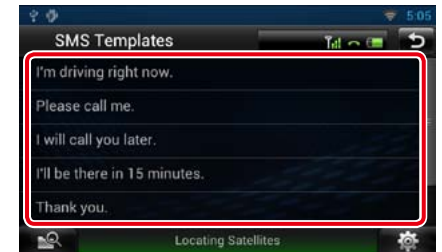

Selected template is entered.

Voice Control

The navigation system is equipped with Advanced Voice Recognition function which allows you to operate it with your voice. The supported languages are US English, UK English, French, German, Dutch, Italian, and Spanish. For information on the voice commands, refer to <Voice command table> (separate volume).

NOTE

- ASR on the Language Setting screen should be set to "Enabled". See [Language setup \(P.110\)](#).

Voice Control

- 1 | Press the Push-To-Talk switch to enter the Voice control mode.



The buttons enclosed in a green square support the voice control.

- 2 | Speak the command. (Ex: Speak "TUNER")

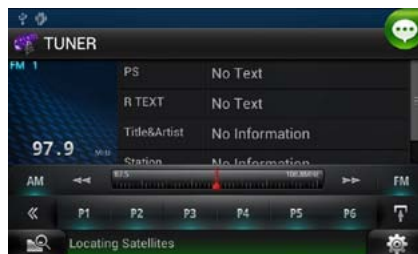

The screen has changed to the TUNER Control screen.

You will hear a beep again.

- 3 | Repeat the same procedure as step 2. For information on the voice commands, refer to <Voice command table> (separate volume).
- 4 | Press the Push-To-Talk switch to end the voice control mode.

Displaying Voice Commands

To display the list of operable voice commands.

- 1 | Press and hold the Push-To-Talk switch.



The list of operable voice commands appears. Pronounce a command.

NOTE

- To cancel the commands list display, press Push-To-Talk switch or touch the screen.

Camera Control

When a CMOS-310/CMOS-300 (optional accessory) is connected, the camera can be controlled from this navigation system.

Camera Control

You can adjust the camera angle of the camera system and display of the guideline.

- 1 | Press the <NAV> button for 1 second.

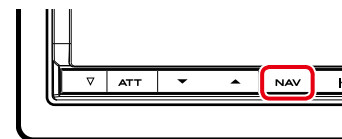

Camera view screen appears.

- 2 | Adjust each item as follows.

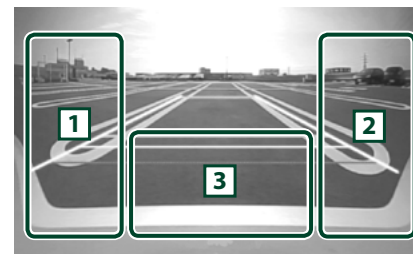

1 | Guideline

Pressing each time turns on or off the guideline display alternately.

2 | ANGLE

Pressing each time changes camera angles in the following order:

Super wide view/ Wide view/ Overhead view/ Wide view + Top view/ Corner view

3

Clearing the Camera View display.

Switching the View Camera

Switching between the front view camera and the rear view camera.

- 1 | Press the <NAV> button for 1 second.

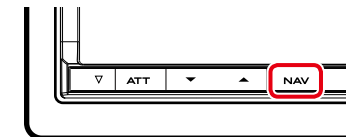

Camera view screen appears.

- 2 | Touch illustrated area during Camera view screen.

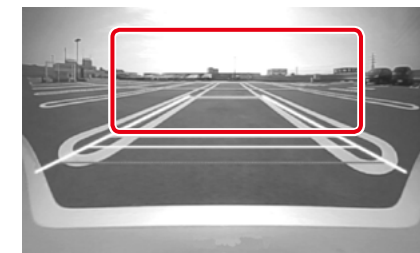

Switches between the front view camera and rear view camera each time you touch the illustrated area.

Setting Up

Monitor Screen Setup

You can adjust image quality of iPod video, picture file, menu screen, etc.

- 1 | Touch and hold the lower left area of any screen.

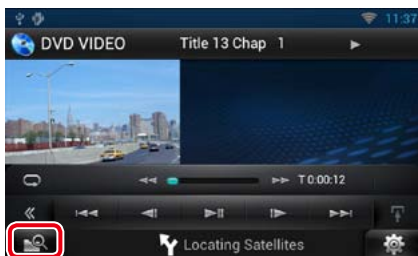

Screen Control screen appears.

- 2 | Adjust each item as follows.



Bright / Tint / Color / Contrast / Black / Sharpness

Adjusts each item.

Dimmer

Select dimmer mode.

ON: The display and buttons dim.

OFF: The display and buttons do not dim.

SYNC (Default): Turns the dimmer function on or off when the vehicle light control switch is turned on or off.

NAV-SYNC: Turns the dimmer function on or off according to the Navigation Day/Night display setting.

Mode (Playback screen only)

Select screen mode.

Full: Full picture mode

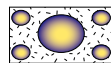

Just: Justify picture mode

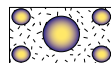

Zoom: Zoom picture mode

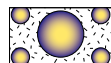

Normal: Normal picture mode

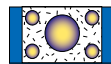

NOTE

- Adjusting items are different depending on the current source.
- You can perform this function only when you have applied the parking brake.
- The image quality can be set for each source.

System Setup

NOTE

- Each operation in this section can be started from the multi function menu.

- 1 | Touch [] on any screen.

Quick Menu screen appears.

- 2 | Touch [SETUP].

- 3 | Touch [System].

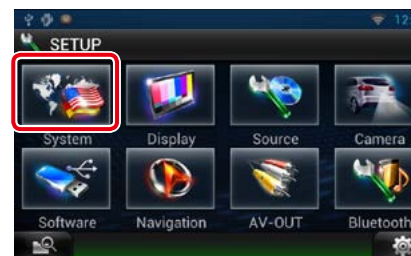

System screen appears.

See the following section for each setting.

- Set up the user interface ([P.109](#))
- Adjust touch panel ([P.110](#))
- Set up security ([P.110](#))
- Set up memory ([P.111](#))

User interface

You can setup user interface parameters.

- 1 | Touch [User Interface] in the list.

User Interface screen appears.

- 2 | Set each item as follows.

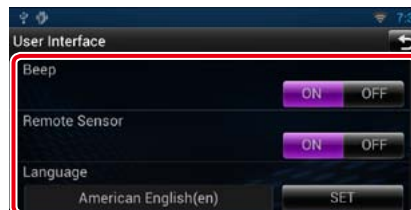

Beep

Turns the key touch tone on or off. Default is "ON".

Remote Sensor

This set item is not available.

Language

Select the language used for the control screen and setting items. See [Language setup \(P.110\)](#).

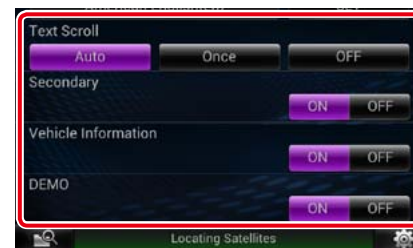

Text Scroll

Allows scrolling of text display on the source control screen. Select from "Auto"/"Once"/"OFF".

Auto (Default): Scrolls the text automatically.

Once: Allows you to scroll the text only once automatically when updated.

OFF: Does not scroll the text automatically.

Secondary

Set whether to display the navigation information in the audio screen or vice versa. Default is "ON".

Vehicle Information

Displays the vehicle information.

This function requires a commercial adaptor. Consult your Kenwood dealer for details.

Demo mode

Set the demonstration mode. Default is "ON".

Language setup

1 | Touch [SET] of [Language] in the User Interface screen.

Language Setting screen appears.

2 | Set each item as follows.

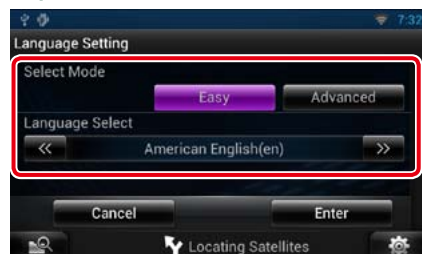

Select Mode

Select the mode to select a language.

Easy (Default): Selects a language easily.

Advanced: Allows you to select languages for respective items.*

Language Select

Select a language.

* If you select [Advanced] for Select Mode, the following screen appears.



GUI Language Select:

Select the language used for the GUI and input methods.

ASR:

Select the language used for voice control function.

Navigation Language Select:

Select the language used for navigation.

STT:

Select the language used for Speech to Text (STT).

TTS:

Select the language used for Text to Speech (TTS).

3 | Touch [Enter].

NOTE

- To cancel the language setup, touch [Cancel].

Touch panel adjustment

1 | Touch [Touch] in the System Menu screen.

Touch Panel Adjustment screen appears.

2 | Follow the instruction on the screen and touch the center of each .

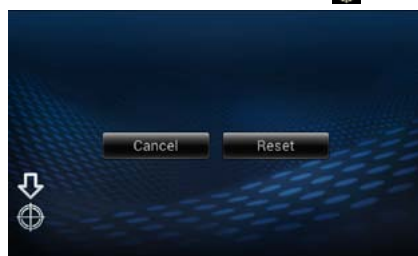

NOTE

- To cancel the touch panel adjustment, touch [Cancel].
- To reset to the initial status, touch [Reset].

Security setup

A red indicator will blink on the unit after the ACC is set to OFF, warning potential thieves.

If turned to "ON" (default), the security indicator on the front panel flashes when the vehicle ignition is off.

1 | Touch [Security] in the System Menu screen.

Security screen appears.

2 | Touch [ON] or [OFF] of [SI].

Setup memory

Audio Control, AV-IN SETUP, Camera, and Audio SETUP settings can be memorized. The memorized settings can be recalled at any time. For example, even when the settings are cleared due to replacement of the battery, the settings can be restored.

1 | Touch [SETUP Memory] in the System Menu screen.

SETUP Memory screen appears.

2 | Follow the instruction on the screen.



[Lock] / [Unlock]*

Locks or unlocks the AV-IN SETUP, and Audio SETUP settings.

Yes

Memorizes or recalls the settings.

No

Cancels the function or memorization. The SETUP Menu screen appears again.

* When [Lock] is selected, you cannot change the AV-IN SETUP, and Audio SETUP settings. Also, the locked key mark is displayed under each setting icon in the setup menu.

3 | Follow the instruction on the screen.



Recall

Recalls the memorized settings.

Memory

Memorizes the current settings.

Clear

Clears the currently memorized settings.

Cancel

Cancels memorization/recalling of settings.

Display Setup

- 1 | Touch [] on any screen.
- 2 | Touch [SETUP].
SETUP Menu screen appears.
- 3 | Touch [Display].



Display screen appears.

See the following section for each setting.

- **Control monitor angle** ([P.112](#))
- **Adjust panel color** ([P.113](#))

Monitor angle control

You can adjust the angle of the monitor.

- 1 | Touch [Angle] in the Display Menu screen.
Angle setup screen appears.
- 2 | Select a number below an angle that will best suit your monitor viewing.



Default is "0".

NOTE

- You can store the current monitor angle as the angle during power off. Touch [Memory] when the desired angle is selected.

Panel color coordinate

You can set the button illumination color.

The selectable items differ depending on the unit.

- 1 | Touch [Color] in the Display Menu screen.
Color screen appears.
- 2 | Touch [SET] of [Panel Color Coordinate].

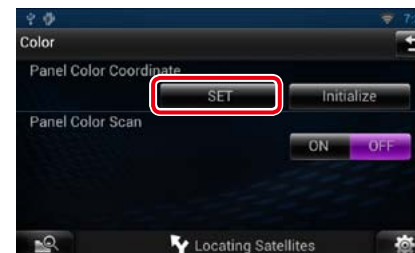

Panel Color Coordinate screen appears.

NOTE

- You can touch [SET] or [Initialize] when [Panel Color Scan] is set to off.
- Touch [Initialize] to reset the settings to the default settings.

- 3 | Touch the desired color.



Registering original color

You can register your original color.

- 1 | Touch [Adjust] in the Panel Color Coordinate screen.
Panel Color RGB Coordinate screen appears.
- 2 | Use [◀] and [▶] to adjust each color value.



- 3 | Touch the desired preset key for 2 seconds.

Panel color scan

You can set the panel color to continuously scan through the color spectrum.

- 1 | Touch [ON] of [Panel Color Scan] in the Color screen.

Panel Color Scan is set to on.

Navigation Setup

You can set navigation parameters.

- 1 | Touch [] on any screen.
- 2 | Touch [SETUP].
 SETUP Menu screen appears.
- 3 | Touch [Navigation].



Navigation SETUP screen appears.

- 4 | Set each item as follows.

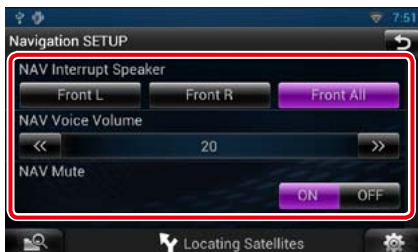

NAV Interrupt Speaker

Select speaker(s) used for voice guidance of the navigation system.

Front L: Uses the front left side speaker for voice guidance.

Front R: Uses the front right side speaker for voice guidance.

Front All (Default): Uses both front speakers for voice guidance.

NAV Voice Volume

Adjust the volume for voice guidance of the navigation system. Default is "20".

NAV Mute

Mutes the volume of rear speakers during voice guidance of the navigation system. Default is "ON".

Camera Setup

You can set camera parameters.

- 1 | Touch [] on any screen.
- 2 | Touch [SETUP].
 SETUP Menu screen appears.
- 3 | Touch [Camera].

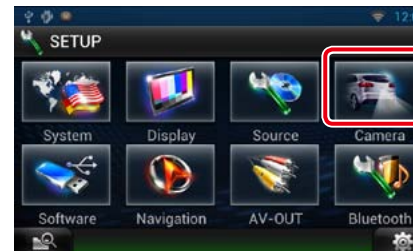

Camera SETUP screen appears.

- 4 | Set each item as follows.



Rear Camera*1

Select the type of rear camera to use.

CMOS-310: When the CMOS-310/CMOS-300 series with ID 1 set is connected.

Other (Default): When the other camera is connected.

R-CAM Interruption

Set a method for switching the display. Setting values are ON and OFF.

ON: Switches to the rear view camera video display when shifting to reverse or pressing the <NAV> button for 1 second.

OFF (Default): Switches to the rear view camera video display when pressing the <NAV> button for 1 second.

R-CAM Settings*2

Adjust the CMOS-310/CMOS-300 series with ID 1 set. For details, see the instruction manual of your camera.

Front Camera*1

Turn this setting on when the CMOS-310/CMOS-300 series with ID 2 set is connected. Setting values are ON and OFF. Default is "OFF".

F-CAM Settings*3

Adjust the CMOS-310/CMOS-300 series with ID 2 set. For details, see the instruction manual of your camera.

*1 These settings become settable only when the parking brake is on.

*2 This setting becomes settable only when the parking brake is on and the CMOS-310/CMOS-300 series is selected.

*3 This setting becomes settable only when the parking brake is on and "Front Camera" is set to [ON].

Software Information

Check the software version of this unit.

- 1 | Touch [] on any screen.
- 2 | Touch [SETUP].
 SETUP Menu screen appears.
- 3 | Touch [Software].

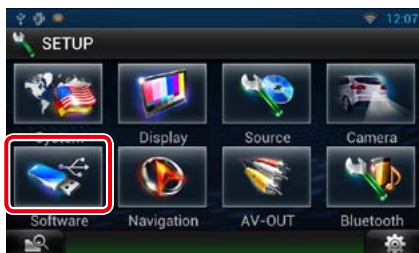

Software Information screen appears.

- 4 | Confirm the software version. Touch [Update] as necessary.

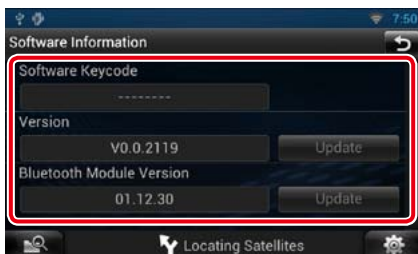

NOTE

- For how to update the software, see the relevant update procedure manual which comes with the software.

AV Input Setup

You can set AV input parameters.

- 1 | Touch [] on any screen.
- 2 | Touch [SETUP].
 SETUP Menu screen appears.
- 3 | Touch [Source].

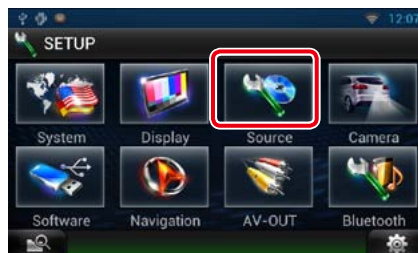

- 4 | Touch [AV-IN SETUP] in the list.
 AV-IN SETUP screen appears.

- 5 | Set each item as follows.



iPod AV Interface Use*1

Set the terminal which iPod is connected.

Setting values are iPod and AV-IN2.

iPod (Default): You can listen to audio or watch video in your iPod as iPod source.

AV-IN2: You can listen to audio in your iPod as iPod source. You can also listen to audio or watch video output from a AV device as AV-IN2 source.

AV-IN1 Name / AV-IN2 Name*2

Set a name to be displayed when you select a system that is connected via the AV INPUT port. Default is "VIDEO".

*1 This item can be set when in STANDBY source and also the iPod is disconnected.

*2 [AV-IN2 Name] becomes settable when "AV-IN2" is selected in [iPod AV Interface Use].

AV Output Interface Setup

You can select an AV source to be output at the AV OUTPUT port. Default is "VIDEO1".

- 1 | Touch [] on any screen.
- 2 | Touch [SETUP].
 SETUP Menu screen appears.
- 3 | Touch [AV-OUT].



AV-OUT Interface screen appears.

- 4 | Touch [◀] or [▶] to set [AV-OUT] to VIDEO, DISC, iPod, or OFF.

Controlling Audio

NOTE

- Each operation in this section can be started from the multi function menu.

You can adjust the various settings such as audio balance or subwoofer level.

1 | Touch [] on any screen.

2 | Touch [Audio].

Audio screen appears.

See the following section for each setting.

- Setting audio [\(P.118\)](#)
- Controlling audio [\(P.121\)](#)
- Controlling equalizer [\(P.122\)](#)
- Controlling sound effect [\(P.123\)](#)
- Performing zone control [\(P.125\)](#)
- Set listening position [\(P.126\)](#)

Setting Audio

1 | Touch [Audio SETUP].

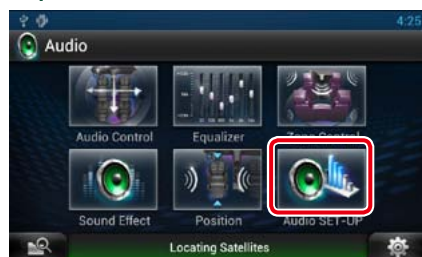

Audio SETUP screen appears.

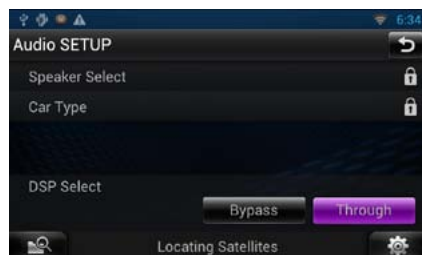

See the following section for each setting.

- Set up speakers [\(P.118\)](#)
- Set up your car type [\(P.120\)](#)
- Select DSP [\(P.121\)](#)

Speaker setup

You can select a speaker type and its size to get the best sound effects.

When the speaker type and size are set, the speaker crossover network is set automatically.

1 | Touch [Speaker Select] in the Audio SETUP screen.

Speaker Select screen appears.



2 | Touch the speaker you wish to adjust and set each item as follows.

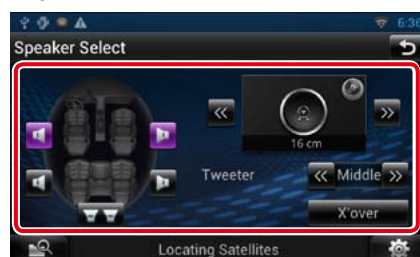

Tweeter

You can set the tweeter when you are selecting front speakers.

None, Small, Middle, Large

X'over

Displays the speaker crossover setup screen.

You can adjust the crossover setup that was set automatically when you selected the speaker type.

For details, see [Crossover network setup \(P.119\)](#)

3 | Select a speaker size using [◀] and [▶]. The speaker size is different depending on the speaker type and the navigation system.

Front

OEM, 8 cm, 10 cm, 12 cm, 13 cm, 16 cm, 17 cm, 18 cm, 4x6, 5x7, 6x8, 6x9, 7x10

Rear

None, OEM, 8 cm, 10 cm, 12 cm, 13 cm, 16 cm, 17 cm, 18 cm, 4x6, 5x7, 6x8, 6x9, 7x10

Subwoofer

None, 16 cm, 20 cm, 25 cm, 30 cm, 38 cm over

NOTE

- Select "None" if you have no speakers.

Crossover network setup

You can set a crossover frequency of speakers.

1 | Touch the speaker to set the crossover in the Speaker Select screen.

2 | Touch [X'over].

X'over screen appears.

3 | Set each item as follows.

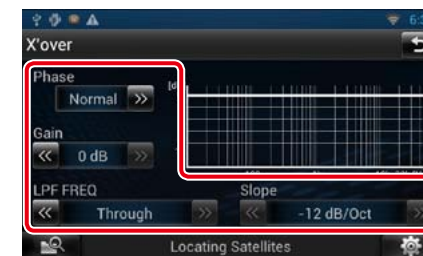

TW (Tweeter) Gain *1

Adjust the tweeter level. (When front is selected on Speaker Select screen)

Gain

Adjust the front speaker, rear speaker, or subwoofer level.

Phase *2

Set the phase of subwoofer output.

The phase is reversed 180 degrees when set to "Reverse". (When subwoofer is selected on Speaker Select screen)

HPF FREQ

High Pass Filter adjustment. (When front or rear speaker is selected on Speaker Select screen)

LPF FREQ

Low Pass Filter adjustment. (When subwoofer is selected on Speaker Select screen)

Slope *3

Set a crossover slope.

*1 Only when "Tweeter" is set to "Small", "Middle", "Large" in <Speaker Setup>.

*2 Only when "Subwoofer" is set to a mode other than "None" in <Speaker Setup>.

*3 Only when "LPF FREQ"/"HPF FREQ" is set to a mode other than "Through" in <X'over>.

Car type setup

You can setup the car type and speaker network, etc.

1 | Touch [Car Type] in the Audio SETUP screen.

Car Type screen appears.

2 | Select your car type from the list.

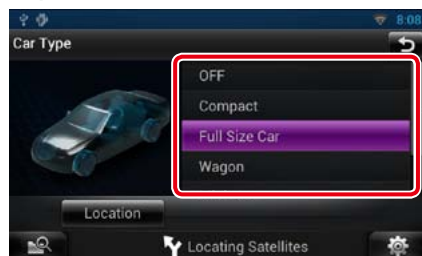

NOTE

- If your car type is selected, the Delay Time Alignment is set automatically (for timing adjustment of sound output for each channel) to have the highest surround effects.

Speaker location setup

1 | In the Car Type screen, touch [Location].

Speaker Location screen appears.

2 | Select the speaker locations using [▶].



Front Speaker

Select the location from "Door"/"On Dash"/"Under Dash".

Rear Speaker

Select the location from "Door"/"Rear Deck", "2nd Row"/"3rd Row" (Minivan, Passenger Van).

DSP select

You can select whether using DSP (Digital Signal Processor) System.

1 | Touch [Bypass] or [Through] of [DSP Select] in the Audio SETUP screen.

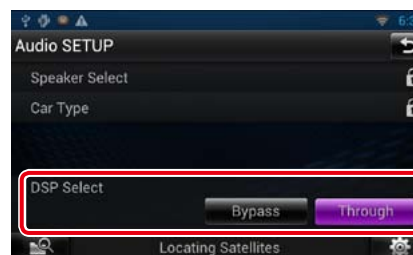

Bypass

There is no effect by DSP.

Through

There is an effect by DSP.

NOTE

- When the mode is set to [Bypass], DSP System cannot be adjusted.

Controlling General Audio

1 | Touch [Audio Control].

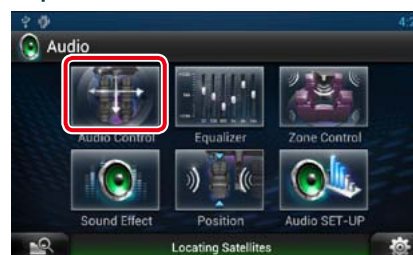

2 | Set each item as follows.



Fader # / Balance

Adjust the volume balance around the touched area.

[◀] and [▶] adjust the right and left volume balance.

[▲] and [▼] adjust the front and rear volume balance.

Volume Offset*

Finely adjust the volume of the current source to minimize the difference in volume between different sources.

Subwoofer Level

Adjust the subwoofer volume. This setting is not available when subwoofer is set to "None". See [Speaker setup \(P.118\)](#).

Bass Boost

Set the amount of bass boost among "OFF"/"Level1"/"Level2"/"Level3".

* If you have increased the volume first, then reduced the volume using the "Volume Offset", the sound generated if you suddenly switch to another source may be extremely loud.

Equalizer Control

You can adjust equalizer by selecting the optimized setting for each category.

1 | Touch [Equalizer].

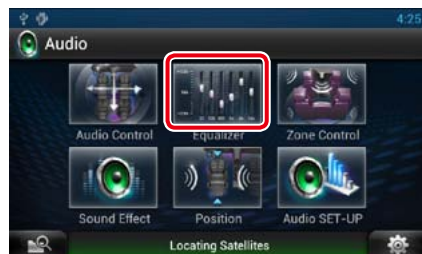

Equalizer screen appears.

Controlling EQ curves

1 | Select EQ curve from [Natural], [Rock], [Pops], [Easy], [Top40], [Jazz], [Powerful], [iPod], and [User].



NOTE

- [iPod] is available only during iPod source.

Controlling equalizer manually

The Graphic Equalizer cannot be set when you select [iPod] in the Equalizer screen.

- 1 | Touch [EQ] in the Equalizer screen.
- 2 | Touch the screen and set the Graphic Equalizer as desired.



Gain level (light green boxed area)

Adjust the gain level by touching the each frequency bar.

Touching [◀], [▶], [▲] and [▼] can also adjust the level. Use [◀] and [▶] to select a frequency, and [▲] and [▼] to set the level.

EQ INIT

Returns to the previous level which the gain level is adjusted.

Flat

Tone curve becomes flat.

Bass EXT (Bass Extend Settings)

When turned on, the frequency lower than 62.5 Hz is set to the same gain level as 62.5 Hz.

Loudness

Set the amounts of boost of low and high tones. "OFF", "Low", "High"

SW Level

Adjust the subwoofer volume. This setting is not available when subwoofer is set to "None". See [Speaker setup \(P.118\)](#).

Sound Effect

You can set sound effects.

1 | Touch [Sound Effect].



Sound Effect screen appears.



See the following section for each setting.

- Set space enhancer [\(P.123\)](#)
- Set highway sound [\(P.124\)](#)
- Set up elevation [\(P.124\)](#)
- Set up realizer or supreme [\(P.124\)](#)

Space Enhancer

1 | Touch [Space Enhancer] in the Sound Effect screen.



Space Enhancer screen appears.

2 | Touch [Small], [Large], or [OFF].

Each setting value indicates the soundscape level.

Highway sound setting

You can boost a certain range of sound that becomes hard to hear due to road noise.

- 1 | Touch **[Highway Sound]** in the **Sound Effect** screen.

Highway Sound screen appears.

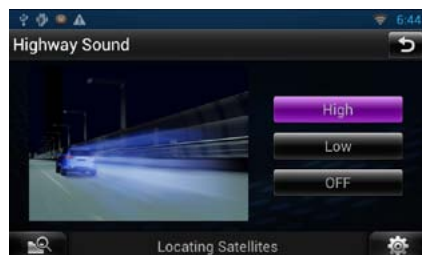

- 2 | Select the boost level from among **[High]**, **[Low]**, and **[OFF]**.

Elevation

You can raise the sound position heard from the speakers virtually.

- 1 | Touch **[Elevation]** in the **Sound Effect** screen.



Elevation screen appears.

- 2 | Select **Elevation** level from **[High]**, **[Low]**, and **[OFF]**.

Realizer and Supreme

You can restore the sound lost due to audio compression to a realistic sound.

- 1 | Touch the screen in the **Sound Effect** screen.



Realizer

Realizer is sound enhancement and boosting low frequencies (bass boost).

Select the level from "OFF"/"Level1"/"Level2"/"Level3".

Supreme

Turns ON/OFF the Supreme function.

Technology to extrapolate and supplement with proprietary algorithm, the high-frequency range that is cut off when encoding.

This function works on DVD MEDIA, USB, SD and iPod sources.

Zone Control

You can select different sources for both front and rear positions in the vehicle.

- 1 | Touch **[Zone Control]**.

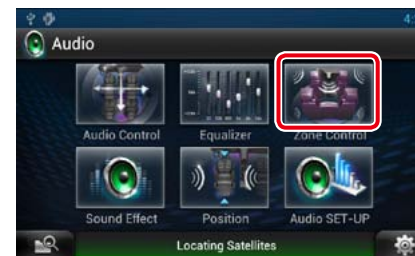

Zone Control screen appears.

- 2 | Touch **[Dual Zone]**.



- 3 | Set each source as follows.



[▶] (Front Source, Rear Source)

Select the audio source for each.

[▼], [▲] (Rear VOL.)

Adjust the rear channel volume.

[Single Zone]

Touch to turn off the dual zone function.

NOTE

- When the rear speaker sound is switched, the audio source that is output at the AV OUTPUT terminal is also switched to the same source.
- When the dual zone function is set to on, the following functions are not available.
 - Output from the subwoofer
 - Subwoofer Level/Bass Boost ([P.121](#))
 - Equalizer Control/Sound Effect/Listening Position ([P.122, 123, 126](#))
 - DSP Bypass Control/Speaker Setup/Car Type Setup ([P.121, 118, 120](#))

Listening Position

You can adjust the sound effects according to your listening position.

1 | Touch [Position].

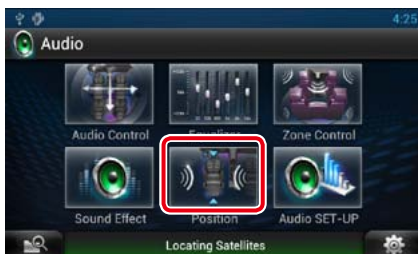

Position screen appears.

2 | Select listening position from [Front R] (Right front), [Front L] (Left front), [Front All] (All front), and [All] using [◀] and [▶].

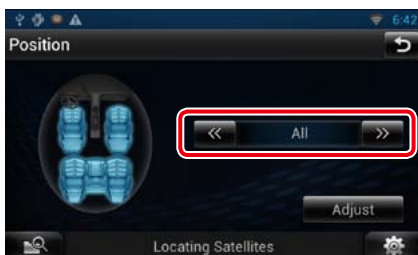

Position DTA Control

You can fine-adjust your listening position.

- 1 | In Position screen, touch [Adjust].
- 2 | Select the speaker you wish to adjust by touching speaker icon.



3 | Set DTA as follows.



[◀], [▶]

Adjust the settings of the DTA position.

Gain

Touch to adjust the gain of each speaker.

Initialize

Initializes the setting values.

NOTE

- Make fine adjustment of the delay time of the speaker output specified here to have a more suitable environment for your vehicle.
- If you specify the distance from the center of the currently set listening position to every speaker, the delay time will be automatically computed and set.
 - ① Determine the center of the currently set listening position as the reference point.
 - ② Measure the distances from the reference point to the speakers.
 - ③ Calculate the differences between the distance of the furthest speaker and other speakers.
 - ④ Input the differences calculated in step 3 for individual speakers.
 - ⑤ Adjust gain for individual speakers. A sound image will be shifted to the speaker with increased gain.

Example: When [Front All] is selected as the listening position

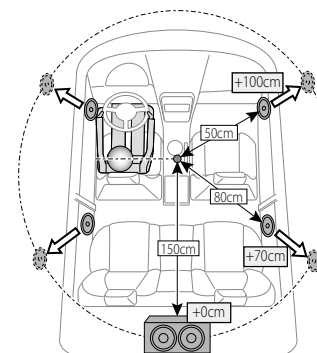

Remote Control

This navigation system can be operated using the remote controller.

CAUTION

- Put the remote controller in a place where it will not move during braking or other operations. A dangerous situation could result, if the remote controller falls down and gets wedged under the pedals while driving.
- Do not leave the battery near fire or under direct sunlight. A fire, explosion or excessive heat generation may result.
- Do not recharge, short, break up or heat the battery or place it in an open fire. Such actions may cause the battery to leak fluid. If spilled fluid comes in contact with your eyes or on clothing, immediately rinse with water and consult a physician.
- Place the battery out of reach of children. In the unlikely event that a child swallows the battery, immediately consult a physician.

Battery Installation

If the remote controller operates only over shorter distances or does not operate at all, it is possible that the batteries are depleted.

In such instances, replace the both batteries with new ones.

- Insert two "AAA"/"R03"-size batteries with the \oplus and \ominus poles aligned properly, following the illustration inside the case.

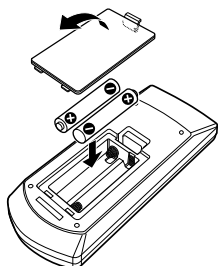

Functions of the Remote Control Buttons

Switching the operation mode

The functions operated from the remote controller differ depending on the position of the mode switch.

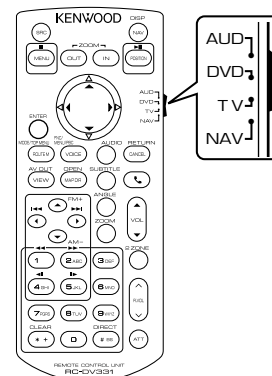

AUD mode

Switch to this mode when controlling a selected source or tuner source, etc.

DVD mode

Switch to this mode when playing a disc media including DVD, VCD, and CD.

NAV mode

Switch to this mode when controlling navigation function.

NOTE

- When controlling a player that is not integrated in the unit, select "AUD" mode.

Direct search mode

Using the remote controller, you can jump directly to the desired file, track chapter, etc. with entering the number corresponding to the content.

NOTE

- This operation cannot be performed for USB device and iPod.

- Press the **<#BS>** button several times until the desired content appears.

The available content are different depending on the source.

DVD

Title number/Chapter number/Play time/Item number*

* You may not be able to use this function with some discs or scenes.

VCD 1.X and 2.X (PBC OFF)

Track number

VCD 2.X (PBC ON)

Scene number/number

Music CD

Track number/Play time

Audio files

Folder number/File number

Radio

Frequency value

- Enter the number of the content you want to play using the numeric keypad.

- For DVD or VCD, press the **<ENTER>** button.
For music CD or audio files, press the **<POSITION>** button.
For radio, press the **<<>** or **<>>** button.

The content you entered is played.

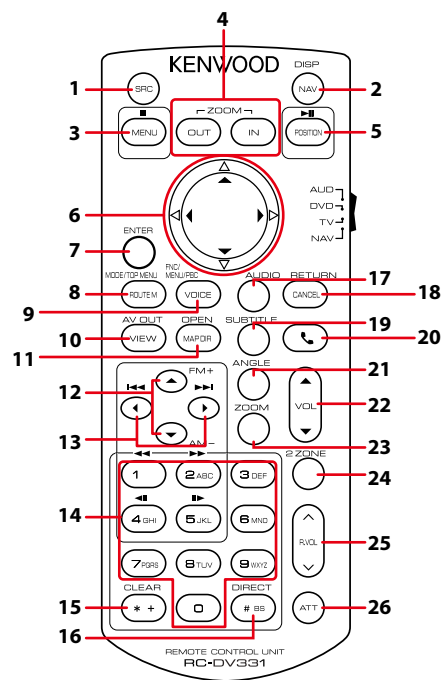

Key Name	Location of the mode switch	Function
1 SRC	—	Switches to the source to be played. In hands-free mode, hangs up the phone.
2 NAV	—	Switches between the navigation and the source screens.
3 MENU	DVD	Stops playing and memorizes the last point where the disc stopped. The last point is deleted by pressing twice.
	NAV	Displays Main menu.
4 OUT, IN	NAV	Zooms in or out the navigation map.
5 POSITION	AUD, DVD	Pauses the track or file, and resumes playing by pressing twice. During radio source in AUD mode, switches the seek mode.
	NAV	Displays the current position.
6 Cursor Key	DVD	Moves the cursor in the DVD menu.
	NAV	Moves the cursor or scrolls the map.
7 ENTER	AUD, DVD	Performs the selected function.
	NAV	<ul style="list-style-type: none"> Registers the selected position. Performs the selected function.
8 ROUTE M	AUD	Screen mode changes each time you press this key during video playback.
	DVD	Returns to the DVD top menu.
	NAV	Displays Route Option menu.

Key Name	Location of the mode switch	Function
9 VOICE	AUD	Switches navigation display on/off.
	DVD	Displays the DVD menu. Turns the playback control on or off while playing VCD.
	NAV	Speaks the voice guidance.
10 VIEW	AUD, DVD	Switches the AV source to be output.
	NAV	Switches between 2D and 3D map displays.
11 MAP DIR	AUD, DVD	Switches the display angle each time it is pressed.
	NAV	Switches between the heading up navigation and north up navigation map displays.
12 ▲/▼	AUD, DVD	Selects the folder to be played. During radio source in AUD mode, switches the bands to be received.
13 ◀▶	AUD, DVD	Selects the track or file to be played. During radio source in AUD mode, switches to broadcast stations received by the unit.
14 Numeric Keypad	AUD	Specifies the number to search in direct search. For details on the direct search mode, see Direct search mode (P.129) .
	DVD	<ul style="list-style-type: none"> Press [1] [2] to fast forward/backward. Switches the fast forward/backward speed each time you press this key.* Press [4] [5] to slow forward/backward. Switches the slow playback speed each time you press this key.* *DVD only
15 * +	DVD	Clears the number.
16 # BS	AUD, DVD	Switches to the direct search mode. For details on the direct search mode, see Direct search mode (P.129) .
17 AUDIO	DVD	Switches the voice language each time you press this key.
18 CANCEL	DVD	Displays previous screen.
	NAV	Cancels the operations.
19 SUBTITLE	DVD	Switches the subtitle language.
20 ☎	—	When a call comes in, answers the call.
21 ANGLE	DVD	Switches the picture angle each time you press this key.
22 Vol ▲▼	—	Adjusts the volume.
23 ZOOM	DVD	Switches the zoom ratio (1, 2, 3, Off) each time you press this key.
24 2 ZONE	AUD, DVD	Switches the Dual Zone function on and off.
25 R.VOL	—	Adjusts volume at rear when the Dual Zone function is on.
26 ATT	—	Lowens the volume by pressing the key once. Restores the previous volume by pressing the key twice.

Troubleshooting

Problems and Solutions

If any trouble occurs, first check the following table for possible problems.

- Some functions of this unit may be disabled by some settings made on this unit.
- What might seem to be a malfunction in your unit may just be the result of slight misoperation or miswiring.

About settings

Problem	Reason	Solution
<ul style="list-style-type: none"> • Cannot set up the subwoofer. • Cannot set up subwoofer phase. 	Subwoofer is not set to on.	Set the subwoofer to on. See Speaker setup (P.118) .
<ul style="list-style-type: none"> • No output from the subwoofer. • Cannot set up the low pass filter. • Cannot set up the high pass filter. 	The dual zone function is enabled.	Set the dual zone function to off. See Zone Control (P.125) .
<ul style="list-style-type: none"> • Cannot select the output destination of the subsource in the dual zone. 	The dual zone function is disabled.	Set the dual zone function to on. See Zone Control (P.125) .
<ul style="list-style-type: none"> • Cannot adjust the volume of the rear speakers. 	The dual zone function is disabled.	Set the dual zone function to on. See Zone Control (P.125) .
<ul style="list-style-type: none"> • Cannot set up the equalizer. • Cannot set up the crossover network. 	The dual zone function is enabled.	Set the dual zone function to off. See Zone Control (P.125) .
	"DSP Select" is set to "Bypass".	Set "DSP Select" to "Through". See DSP select (P.121) .

About audio operations

Problem	Reason	Solution
Radio reception is poor.	The car antenna is not extended.	Pull out the antenna all the way.
	The antenna control wire is not connected.	Connect the wire correctly. See "Connection" in the Quick Start Guide.
Cannot play audio files stored in a disc.	"CD Read" is set to "2".	Set "CD Read" to "1". See Disc setup (P.61) .
Cannot select a folder.	The random play function is enabled.	Turn off the random function.
Cannot perform repeat play during VCD playback.	The PBC function is enabled.	Turn off the PBC function.
The specified disc does not play, but another one plays instead.	The disc is quite dirty.	Clean the disc. See Precautions on handling discs (P.4) .
	The disc is severely scratched.	Try another disc instead.

Problem	Reason	Solution
The sound skips when an audio file is being played.	The disc is scratched or dirty.	Clean the disc. See Precautions on handling discs (P.4) .
	The recording condition is bad.	Record the file again or use another disc.

Other

Problem	Reason	Solution
The Touch Sensor Tone doesn't sound.	The preout jack is being used.	The Touch Sensor Tone cannot be output from the preout jack.

Error Messages

When you fail to operate the unit correctly, the cause of the failure appears as the message on the screen.

Error Message	Cause	Solution
Protect	Protective circuit has been activated because a speaker cord has shorted or it has come in contact with the car chassis.	Wire or insulate the speaker cord as appropriate and then press the <Reset> button (P.135) .
Hot Error	When the internal temperature of this unit rises to 60°C or more, the protection circuit is activated and you may not be able to operate the unit.	Use the unit again after reducing the temperature of the unit.
Mecha Error	The disc player is malfunctioning.	Eject the disc and try inserting it again. Contact the Kenwood dealer if this indicator continues blinking or the disc cannot be ejected.
Disc Error	An unplayable disc is inserted.	Change the disc. See Playable Media and Files (P.136) .
Read Error	The disc is quite dirty.	Clean the disc. See Precautions on handling discs (P.4) .
	Disc is upside down.	Load the disc with the labeled side up.
Region Code Error	The disc you wanted to play has a region code that cannot be played with this unit.	See Region Codes in the World (P.141) or try another disc.
Parental Level Error	The disc you wanted to play has a higher level than the parental level you set.	Set the parental level. See Parental level (P.61) .
Error 07-67	The unit is not operating correctly due to some reason or other.	Push the unit's Reset button. If the "Error 07-67" message does not disappear, see your nearest Kenwood dealer.
No Device (USB device)	The USB device is selected as a source although no USB device is connected.	Change the source to any source other than USB/iPod. Connect a USB device, and change the source to USB again.

Error Message	Cause	Solution
Disconnected (iPod, Bluetooth audio player)	The iPod/Bluetooth audio player is selected as a source although no iPod/Bluetooth audio player is connected.	Change the source to any source other than iPod/Bluetooth. Connect an iPod/Bluetooth audio player, and change the source to iPod/Bluetooth again.
No Media file	The connected USB device contains no playable audio file. Media was played that doesn't have data recorded that the unit can play.	See Playable Media and Files (P.136) and try another USB device.
USB Device Error!!	The connected USB device is rated a current capacity higher than the allowable limit.	Check the USB device. Some trouble may have occurred to the connected USB device. Change the source to any source other than USB. Remove the USB device.
Authorization Error	Connection to the iPod has failed.	<ul style="list-style-type: none"> Remove the iPod and then reconnect it. The unit does not support the iPod. See Connectable iPod/iPhone (P.138).
Update your iPod	The iPod's software is an older version which the unit can not support.	The unit may not support the connected iPod model. Confirm that the software for the iPod is the latest version. See Connectable iPod/iPhone (P.138) .
Navigation Error. Please turn on power again later.	The communication error has occurred due to severely cold temperature.	Turn on power again after warming your car interior.
Network is disconnected	Not connected to Wi-Fi.	Connect to Wi-Fi.
Account Error	Logged in using Guest or Administrator account.	To link to the Route Collector site, log in using Owner or User account and then use the Storage application.
Your Dropbox and Kenwood accounts are not linked.	Dropbox account information is not registered to the logged in Owner or User account.	Log in Route Collector site and register the Dropbox account

Resetting the Navigation System

If the navigation system or the connected device fails to operate properly, reset the navigation system.

1 Press the <Reset> button.

The unit returns to factory settings.

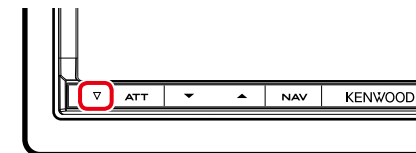

NOTE

- Disconnect the USB device before pressing the <Reset> button. Pressing the <Reset> button with the USB device connected can damage the data stored in the USB device. For how to disconnect the USB device, see [How to Play Media \(P.18\)](#).
- When the navigation system is turned on after resetting, the Initial SETUP screen appears. See [Initial setup \(P.14\)](#).

Appendix

Playable Media and Files

You can play various kinds of media and files on this navigation system.

List of playable discs

Disc types	Standard	Support	Remark
DVD	DVD Video	○	
	DVD Audio	×	
	DVD-VR	×	
	DVD-R*1	○	• MP3/WMA/AAC/MPEG1/MPEG2/DivX playback • Multi-border/Multisession playback (Playback depends on authoring conditions)
	DVD-RW	○	
	DVD+R	○	
	DVD+RW	○	
	DVD-R DL (Dual layer)	○	Only video format
	DVD+R DL (Double layer)	○	
DVD-RAM	×		
CD	Music CD*1	○	CD-TEXT
	CD-ROM	○	• MP3/WMA/AAC/MPEG1/MPEG2/DivX playback
	CD-R	○	• Multisession is supported.
	CD-RW	○	• Packet write is not supported.
	DTS-CD	○	
	Video CD (VCD)	○	
	Super video CD	×	
	Photo CD	×	
	CD-EXTRA	△	Only music CD session can be played.
	HDCD	○	
	CCCD	×	
Others	Dualdisc	×	
	Super audio CD	△	Only CD layer can be played.

*1 Incompatible with 8 cm (3 inch) discs.

○ : Playback is possible.

△ : Playback is partly possible.

×

 : Playback is impossible.

NOTE

- When buying DRM enabled content, check the Registration Code in the [DivX® VOD \(P.73\)](#). Each time a file with the displayed code is played and protected against copying, the code changes.
- DivX can be played only from a DVD disc media.

● Use of DualDisc

When playing a "DualDisc" on this unit, the surface of the disc that is not played may be scratched while the disc is inserted or ejected. Since the music CD surface does not conform to the CD standard, playback may be impossible.

(A "DualDisc" is a disc with one surface containing DVD standard signals and the other surface containing music CD signals.)

● About disc format

The disc format should be the one of the following.

- ISO 9660 Level 1/2
- Joliet
- Romeo
- Long file name

● About files

The following audio, video, and picture files are supported.

● Audio files

- AAC-LC (.m4a)
- MP3 (.mp3)
- WMA (.wma)
- Linear PCM (WAVE) (.wav)
*Mass-storage-class USB device only

NOTE

- If music of normal CD and other playback systems are recorded in the same disc, only the playback system recorded at the first setout is played.
- WMA and AAC of which is covered with DRM cannot be played.
- Although the audio files are complied with the standards listed above, the play may be impossible depending on the types or conditions of media or device.
- An online manual about audio files is posted on the site, www.kenwood.com/cs/ce/audiofile/. On this online manual, detailed information and notes which are not written in this manual are provided. Make sure to read through the online manual as well.

● Video files

- MPEG1 (.mpg, .mpeg, .m1v)
- MPEG2 (.mpg, .mpeg, .m2v)
- DivX (.divx, .div, .avi)
*Only for DVD
- H.264/MPEG-4 AVC (.mp4, .m4v)
*Mass-storage-class USB device only
- WMV 9 (.wmv, .m2ts)
*Mass-storage-class USB device only

● Picture files

Only picture files in USB device can be displayed.

Files stored in disc media is not supported.

- JPEG (.jpg, .jpeg)
- PNG (.png)
- BMP (.bmp)

NOTE

- BMP and PNG can be set only as wallpaper.

● Playing order of files

In the example of folder/file tree shown below, the files are played in the order from ① to ⑩.

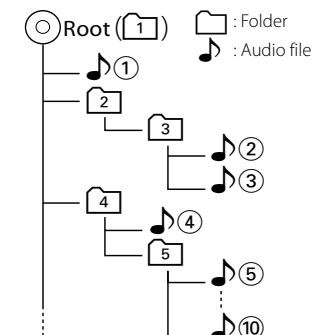

Connectable iPod/iPhone

The following models can be connected to this navigation system.

You can control an iPod/iPhone from this navigation system by connecting an iPod/iPhone (commercial product) with Dock connector using an optional accessory iPod connection cable (KCA-iP202 or KCA-iP102). The word "iPod" appearing in this manual indicates the iPod/iPhone connected with the KCA-iP202/KCA-iP102 (optional accessory) connector.

Made for

- iPod nano (6th generation)
- iPod nano (5th generation)
- iPod nano (4th generation)
- iPod nano (3rd generation)
- iPod with video
- iPod classic
- iPod touch (4th generation)
- iPod touch (3rd generation)
- iPod touch (2nd generation)
- iPod touch (1st generation)
- iPhone 4S
- iPhone 4
- iPhone 3GS
- iPhone 3G
- iPhone

NOTE

- For the conformity information on iPod/iPhone software, access www.kenwood.com/cs/ce/ipod/.
- By connecting your iPod/iPhone to this unit with an optional accessory iPod connection cable (KCA-iP202/ KCA-iP102), you can supply power to your iPod/iPhone as well as charge it while playing music. However, the power of this unit must be on.
- If you start playback after connecting the iPod, the music that has been played by the iPod is played first.
In this case, "Reading" is displayed without displaying a folder name, etc. Changing the browse item will display a correct title, etc.
- When the iPod is connected to this unit, "KENWOOD" or "✓" is displayed on the iPod to indicate that you cannot operate the iPod.

Usable USB device

You can use a mass-storage-class USB device on this navigation system.

The word "USB device" appearing in this manual indicates a flash memory device and digital audio players can be recognized as mass-storage.

● About file system

The file system should be the one of the following.

- FAT16
- FAT32

NOTE

- When the USB device is connected to this unit, it can be charged through the USB cable.
- Install the USB device in the place where it will not affect safe driving.
- You cannot connect a USB device via a USB hub and Multi Card Reader.
- Take backups of the audio files used with this unit. The files can be erased depending on the operating conditions of the USB device. We shall have no compensation for any damage arising from any erased data.
- No USB device comes with this unit. You need to purchase a commercially available USB device.
- When connecting the USB device, usage of the CA-U1EX (option) is recommended. (However, maximum supply current of CA-U1EX is 500mA.) Normal playback is not guaranteed when a cable other than the USB compatible cable is used.

Status Bar Indicator Items

Shown below is a list of indicators displayed on the status bar in the screen. Current status of this navigation system is displayed on the bar.

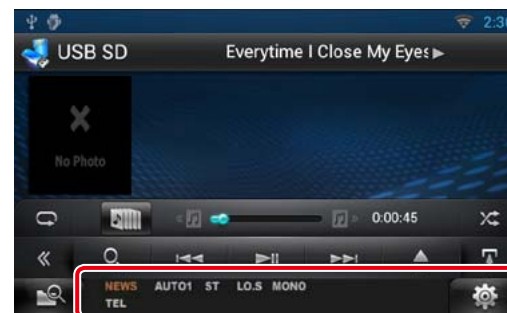

● General

ATT

The attenuator is active.

DUAL

The dual zone function is on.

TEL

Indicates the connection state of the Bluetooth hands-free unit.

- White: Connected
- Orange: Not connected

LOUD

The loudness control function is on.

● DVD/CD

FO-REP

Folder repeat function is on.

IN

A disc is inserted.

- White: A Disc is inside the unit.
- Orange: Error at the disc player

VIDEO

Identifies the video file.

MUSIC

Identifies the music file.

RDM

The random function is on.

REP

The repeat function is on.

C-REP

The chapter repeat function is on.

T-REP

The title repeat function is on.

● VCD

1chLL/2chLL

Identifies the left audio output of channel 1 or 2.

1chLR/2chLR

Identifies the monaural audio output of channel 1 or 2.

1chRR/2chRR

Identifies the right audio output of channel 1 or 2.

1chST/2chST

Identifies the stereo audio output of channel 1 or 2.

LL

Identifies the left audio output.

LR

Identifies the monaural audio output.

RR

Identifies the right audio output.

STEREO

Identifies the stereo audio output.

PBC

The PBC function is on.

SVCD

Identifies the Super Video CD.

VER1

The VCD version is 1.

VER2

The VCD version is 2.

REP

The repeat function is on.

● USB SD

FO-REP

The folder repeat function is on.

VIDEO

Identifies the video file.

MUSIC

Identifies the music file.

RDM

The random function is on.

REP

The repeat function is on.

PLST

The play list mode is selected now.

● iPod

MUSIC

Identifies the music file.

VIDEO

Identifies the video file.

RDM

The random function is on.

A-RDM

The album random function is on.

REP

The repeat function is on.

● Digital Radio

Digital Radio

Digital Radio is being received.

RDS

Radio Data System is being received.

AUTO1

Seek mode is set to AUTO1.

AUTO2

Seek mode is set to AUTO2.

MANUAL

Seek mode is set to MANUAL.

MC

Receiving service is displayed.

- White: Primary Component is received.
- Orange: Secondary Component is received.

● Tuner

AUTO1

Seek mode is set to AUTO1.

AUTO2

Seek mode is set to AUTO2.

MONO

The forced monaural function is on.

AF

The AF search function is on.

EON

The Radio Data System station is sending EON.

Lo.S

The Local Seek function is on.

NEWS

News bulletin interruption is in progress.

RDS

Indicates the state of the Radio Data System station when the AF function is on.

- White: Radio Data System is being received.
- Orange: Radio Data System is not being received.

MANUAL

Seek mode is set to MANUAL.

ST

A stereo broadcast is being received.

TI

Indicates the reception state of traffic information.

- White: TP is being received.
- Orange: TP is not being received.

Region Codes in the World

The DVD players are given a region code according to the country or area it is marketed, as shown in the following map.

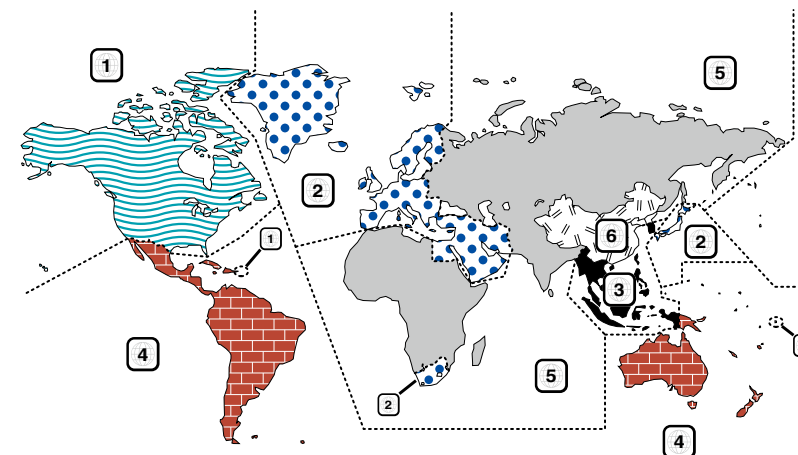

● DVD disc marks



Indicates a region number. The discs with this mark can be played with any DVD player.



Indicates the number of audio languages recorded. Up to 8 languages can be recorded in a movie. You can select a favorite language.



Indicates the number of subtitled languages recorded. Up to 32 languages can be recorded.



If a DVD disc has scenes shot from multiple angles, you can select a favorite angle.

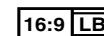

Indicates the type of screen for the image. The left mark indicates that a wide image picture (16:9) is displayed on a standard TV set screen (4:3) with a black band at both the top and bottom of the screen (letter box).

● Operation regulatory marks

With this DVD, some functions of this unit such as the play function may be restricted depending on the location where the DVD is playing. In this case, the following marks will appear on the screen. For more information, refer to the disc manual.



● Discs with limited period of use

Do not leave discs with a limited period of use in this unit. If you load an already expired disc, you may not be able to remove it from this unit.

DVD Language Codes

Code	Language
aa	Afar
ab	Abkhazian
af	Afrikaans
am	Amharic
ar	Arabic
as	Assamese
ay	Aymara
az	Azerbaijani
ba	Bashkir
be	Byelorussian
bg	Bulgarian
bh	Bihari
bi	Bislama
bn	Bengali, Bangla
bo	Tibetan
br	Breton
ca	Catalan
co	Corsican
cs	Czech
cy	Welsh
da	Danish
de	German
dz	Bhutani
el	Greek
en	English
eo	Esperanto
es	Spanish
et	Estonian
eu	Basque
fa	Persian
fi	Finnish
fj	Fiji
fo	Faroese
fr	French
fy	Frisian
ga	Irish
gd	Scots Gaelic
gl	Galician
gn	Guarani
gu	Gujarati
ha	Hausa
he	Hebrew
hi	Hindi
hr	Croatian
hu	Hungarian
hy	Armenian

Code	Language
ia	Interlingua
ie	Interlingue
ik	Inupiak
id	Indonesian
is	Icelandic
it	Italian
ja	Japanese
jav	Javanese
ka	Georgian
kk	Kazakh
kl	Greenlandic
km	Cambodian
kn	Kannada
ko	Korean
ks	Kashmiri
ku	Kurdish
ky	Kirghiz
la	Latin
lb	Luxembourgish
ln	Lingala
lo	Laotian
lt	Lithuanian
lv	Latvian, Lettish
mg	Malagasy
mi	Maori
mk	Macedonian
ml	Malayalam
mn	Mongolian
mo	Moldavian
mr	Marathi
ms	Malay
mt	Maltese
my	Burmese
na	Nauru
ne	Nepali
nl	Dutch
no	Norwegian
oc	Occitan
om	(Afan) Oromo
or	Oriya
pa	Punjabi
pl	Polish
ps	Pashto, Pushto
pt	Portuguese
qu	Quechua
rm	Rhaeto-Romance

Code	Language
rn	Kirundi
ro	Romanian
ru	Russian
rw	Kinyarwanda
sa	Sanskrit
sd	Sindhi
sg	Sangho
sh	Serbo-Croatian
si	Singhalese
sk	Slovak
sl	Slovenian
sm	Samoaan
sn	Shona
so	Somali
sq	Albanian
sr	Serbian
ss	Siswati
st	Sesotho
su	Sundanese
sv	Swedish
sw	Swahili
ta	Tamil
te	Telugu
tg	Tajik
th	Thai
ti	Tigrinya
tk	Turkmen
tl	Tagalog
tn	Setswana
to	Tongan
tr	Turkish
ts	Tsonga
tt	Tatar
tw	Twi
uk	Ukrainian
ur	Urdu
uz	Uzbek
vi	Vietnamese
vo	Volapuk
wo	Wolof
xh	Xhosa
yo	Yoruba
zh	Chinese
zu	Zulu

Specifications

● Monitor section

Picture Size
: 6.95 inches (diagonal) wide
: 156.6 mm (W) x 81.6 mm (H)

Display System
: Transparent TN LCD panel

Drive System
: TFT active matrix system

Number of Pixels
: 1,152,000 (800H x 480V x RGB)

Effective Pixels
: 99.99 %

Pixel Arrangement
: RGB striped arrangement

Back Lighting
: LED

● DVD player section

D/A Converter
: 24 bit

Audio Decoder
: Linear PCM/Dolby Digital/dts/MP3/WMA/AAC

Video Decoder
: MPEG1/ MPEG2/ DivX

Wow & Flutter
: Below Measurable Limit

Frequency Response
• 96 kHz : 20 – 20,000 Hz
• 48 kHz : 20 – 20,000 Hz
• 44.1 kHz : 20 – 20,000 Hz

Total Harmonic Distortion
: 0.008 % (1 kHz)

S/N Ratio (dB)
: 100 dB (DVD-Video 96 kHz)

Dynamic Range
: 100 dB (DVD-Video 96 kHz)

Disc Format
: DVD-Video/ VIDEO-CD/ CD-DA

Sampling Frequency
: 44.1/48/96 kHz

Quantifying Bit Number
: 16/20/24 bit

● USB interface section

USB Standard
: USB 2.0 High speed

File System
: FAT 16/ 32

Maximum Power Supply Current
iPod/iPhone: DC 5 V $\overline{\text{---}}$ 1 A
USB: DC 5 V $\overline{\text{---}}$ 500 mA

D/A Converter
: 24 Bit

Video Decoder
: MPEG1/MPEG2/MPEG4/WMV/H.264

Audio Decoder
: MP3/ WMA/ AAC/ WAV

● SD

SD Standard
: SD/ SD-HC

Compatible File System
: FAT 12/16/32

Capacity
: Maximum 32G Byte

Video Decoder
: MPEG1/MPEG2/MPEG4/WMV/H.264

Audio Decoder
: MP3/WMA/AAC/WAV

● Network section

uPnp
: Media Controller/Media Server/Media player/Media
Renderer

Video Decoder
: MPEG1/MPEG2/MPEG4/WMV/H.264

Audio Decoder
: MP3/WMA/AAC/WAV

● Wi-Fi section

IEEE Standard
: 802.11b/g/n

Security Support
: 64/128bit WEP / WPA & WPA2

Frequency Range
: 2.401 – 2.483 GHz

Transfer rates (MAX)
: 802.11n(150 Mbps) / 802.11g(54 Mbps) /
802.11b(11 Mbps)

Output Power
: 16 – 18dBm (CCK), 13 – 15dBm (OFDM)

● Bluetooth section

Technology
: Bluetooth Ver4.0 Certified

Frequency
: 2.402 – 2.480 GHz

Output Power
: +4dBm (MAX), 0dBm (AVE), Power Class2

Maximum Communication Range
: Line of sight approx. 10m (32.8 ft)

Profile

- HFP (Hands Free Profile)
- SPP (Serial Port Profile)
- A2DP (Advanced Audio Distribution Profile)
- AVRCP (Audio/Video Remote Control Profile)
- OPP (Object Push Profile)
- PBAP (Phonebook Access Profile)
- Multi Profile support

● DSP section

Graphics equalizer
Band: 13 Band
Frequency (BAND1 – 13)
: 62.5/100/160/250/400/630/1k/1.6k/2.5k/4k/6.3k/
10k/16k Hz

Gain
: -9/-8/-7/-6/-5/-4/-3/-2/-1/0/1/2/3/4/5/6/7/8/9 dB

X'over

Front/ Rear High pass filter
Frequency: Through, 30/ 40/ 50/ 60/ 70/ 80/ 90/ 100/
120/ 150 / 180/ 220/ 250 Hz

Slope: -6/-12/-18/-24 dB/Oct.
Subwoofer Low pass filter
Frequency: 30/ 40/ 50/ 60/ 70/ 80/ 90/ 100/ 120/
150/ 180/ 220/ 250 Hz, Through
Slope: -6/-12/-18/-24 dB/Oct.

Position

Front / Rear /Subwoofer Delay
: 0 – 610 cm (2 cm Step)

Gain
: -8 – 0 dB

Subwoofer level
: -50 – +10 dB

● FM tuner section

Frequency Range (step)
: 87.5 MHz – 108.0 MHz (50 kHz)

Usable Sensitivity (S/N : 26 dB)
: 0.63 μ V/75 Ω

Quieting Sensitivity (S/N : 46 dB)
: 15.2 dBf (1.6 μ V/75 Ω)

Frequency Response (\pm 3.0 dB)
: 30 Hz – 15 kHz

S/N Ratio (dB)
: 75 dB (MONO)

Selectivity (\pm 400 kHz)
: Over 80 dB

Stereo Separation
: 45 dB (1 kHz)

● AM tuner section

Frequency Range (step)
LW : 153 – 279 kHz (9 kHz)
MW : 531 – 1611 kHz (9 kHz)

Usable Sensitivity
MW : 25 μ V
LW : 45 μ V

● DAB section

Frequency Range
L-BAND: 1452.960 – 1490.624 (MHz)
BAND III: 174.928 – 239.200 (MHz)

Sensitivity
: -100 dBm

S/N Ratio (dB)
: 90 dB

● Digital Antenna Connector section

Connector type
: SMB

Output Voltage (11 – 16V)
: 14.4 V

Maximum Current
: < 100 mA

● Video section

Color System of External Video Input
: NTSC/PAL

External Video Input Level (RCA/mini jack)
: 1 Vp-p/ 75 Ω

External Audio Max Input Level (RCA/mini jack)
: 2 V/ 25 k Ω

Video Input Level (RCA jacks)
: 1 Vp-p/ 75 Ω

Video Output Level (RCA jacks)
: 1 Vp-p/ 75 Ω

Audio Output Level (Mini jack)
: 1.2 V/ 10 k Ω

● Audio section

Maximum Power (Front & Rear)
: 50 W x 4

Full Bandwidth Power (Front & Rear) (4 Ω , 14.4 V, 1
% THD)
: 22 W x 4

Preout Level (V)
: 5 V/ 10 k Ω

Preout Impedance
: \leq 80 Ω

Speaker Impedance
: 4 – 8 Ω

● Navigation section

Receiver

: High-sensitivity GPS receiver

Reception Frequency

: 1575.42 MHz (C/A code)

Acquisition Times

Cold : 26 seconds (typ)
(All satellites at -130 dBm Without aiding)

Update Rate

: 1/second, continuous

Accuracy

Position: <2.5 meters, CEP, at -130 dBm
Velocity: 0.1 meter/sec RMS

Position Method

: GPS

Antenna

: External GPS antenna

● General

Operating Voltage

: 14.4 V (10.5 – 16 V allowable)

Maximum Current Consumption

: 10 A

Installation Dimensions (W × H × D)

: 182 × 112 × 163 mm

Operational Temperature Range

: -10 °C – +60 °C

Weight

: 2.6 kg

NOTE

- Although the effective pixels for the liquid crystal panel is given as 99.99% or more, 0.01% of pixels may not light or may light incorrectly.

Specifications subject to change without notice.

Trademarks

- The Bluetooth word mark and logos are owned by the Bluetooth SIG, Inc. and any use of such marks by JVC KENWOOD Corporation is under license. Other trademarks and trade names are those of their respective owners.



- The "AAC" logo is a trademark of Dolby Laboratories.



- Microsoft and Windows Media are either registered trademarks or trademarks of Microsoft Corporation in the United States and/or other countries.



- "Made for iPod" and "Made for iPhone" mean that an electronic accessory has been designed to connect specifically to iPod or iPhone, respectively, and has been certified by the developer to meet Apple performance standards. Apple is not responsible for the operation of this device or its compliance with safety and regulatory standards. Please note that the use of this accessory with iPod or iPhone may affect wireless performance.



- iPhone, iPod, iPod classic, iPod nano, and iPod touch are trademarks of Apple Inc., registered in the U.S. and other countries.

- iTunes is a trademark of Apple Inc.

-  is a trademark of DVD Format/Logo Licensing Corporation registered in the U.S., Japan and other countries.



- This item incorporates copy protection technology that is protected by U.S. patents and other intellectual property rights of Rovi Corporation. Reverse engineering and disassembly are prohibited.

- Manufactured under license from Dolby Laboratories. Dolby and the double-D symbol are trademarks of Dolby Laboratories.



- Manufactured under license under U.S. Patent Nos: 5,956,674; 5,974,380; 6,487,535 & other U.S. and worldwide patents issued & pending. DTS, the Symbol, & DTS and the Symbol together are registered trademarks & DTS 2.0 Channel is a trademark of DTS, Inc. Product includes software. © DTS, Inc. All Rights Reserved.



- DAB+



- Wi-Fi is a registered trademark of the Wi-Fi Alliance.



- Google, the Google logo, Android, Gmail, and YouTube are trademarks of Google Inc.
- SDHC Logo is a trademark of SD-3C, LLC.



- Twitter is a registered trademark of Twitter, Inc.
- Facebook® is a registered trademark of Facebook Inc.
- INRIX is a registered trademark of INRIX, Inc.
- Nuance is a registered trademark of Nuance Communications, Inc.
- "aupeo" is a trade mark of Aupeo Ltd.
- Dropbox is a trademark of Dropbox Inc.

- ABOUT DIVX VIDEO: DivX® is a digital video format created by DivX, LLC, a subsidiary of Rovi Corporation. This is an official DivX Certified® device that plays DivX video. Visit divx.com for more information and software tools to convert your files into DivX videos.

- ABOUT DIVX VIDEO-ON-DEMAND: This DivX Certified® device must be registered in order to play purchased DivX Video-on-Demand (VOD) movies. To obtain your registration code, locate the DivX VOD section in your device setup menu. Go to vod.divx.com for more information on how to complete your registration.

- DivX®, DivX Certified® and associated logos are trademarks of Rovi Corporation or its subsidiaries and are used under license.



Safety precaution

● The marking of products using lasers

**CLASS 1
LASER PRODUCT**

The label is attached to the chassis/case and says that the component uses laser beams that have been classified as Class 1. It means that the unit is utilizing laser beams that are of a weaker class. There is no danger of hazardous radiation outside the unit.

● Information on Disposal of Old Electrical and Electronic Equipment and Batteries (applicable for EU countries that have adopted separate waste collection systems)

Products and batteries with the symbol (crossed-out wheeled bin) cannot be disposed as household waste. Old electrical and electronic equipment and batteries should be recycled at a facility capable of handling these items and their waste byproducts.

Contact your local authority for details in locating a recycle facility nearest to you.

Proper recycling and waste disposal will help conserve resources whilst preventing detrimental effects on our health and the environment.

Notice: The sign "Pb" below the symbol for batteries indicates that this battery contains lead.



● About W02-5617 (USB Wi-Fi® adapter)

The Wi-Fi Adapter is attached to this unit when shipped from the factory. When the adapter is removed, store it in a safe place.



Declaration of Conformity with regard to the EMC Directive 2004/108/EC
Declaration of Conformity with regard to the R&TTE Directive 1999/5/EC

Manufacturer:

JVC KENWOOD Corporation
3-12, Moriyacho, Kanagawa-ku, Yokohama-shi, Kanagawa 221-0022, JAPAN

EU Representative's:

Kenwood Electronics Europe BV
Amsterdamseweg 37, 1422 AC UITHOORN, The Netherlands

English

Hereby, JVC KENWOOD declares that this unit DNN9230DAB is in compliance with the essential requirements and other relevant provisions of Directive 1999/5/EC.

Français

Par la présente JVC KENWOOD déclare que l'appareil DNN9230DAB est conforme aux exigences essentielles et aux autres dispositions pertinentes de la directive 1999/5/CE.

Par la présente, JVC KENWOOD déclare que ce DNN9230DAB est conforme aux exigences essentielles et aux autres dispositions de la directive 1999/5/CE qui lui sont applicables.

Deutsch

Hiermit erklärt JVC KENWOOD, dass sich dieser DNN9230DAB in Übereinstimmung mit den grundlegenden Anforderungen und den anderen relevanten Vorschriften der Richtlinie 1999/5/EG befindet. (BMWf)

Hiermit erklärt JVC KENWOOD die Übereinstimmung des Gerätes DNN9230DAB mit den grundlegenden Anforderungen und den anderen relevanten Festlegungen der Richtlinie 1999/5/EG. (Wien)

Nederlands

Hierbij verklaart JVC KENWOOD dat het toestel DNN9230DAB in overeenstemming is met de essentiële eisen en de andere relevante bepalingen van richtlijn 1999/5/EG.

Bij deze verklaart JVC KENWOOD dat deze DNN9230DAB voldoet aan de essentiële eisen en aan de overige relevante bepalingen van Richtlijn 1999/5/EC.

Italiano

Con la presente JVC KENWOOD dichiara che questo DNN9230DAB è conforme ai requisiti essenziali ed alle altre disposizioni pertinenti stabilite dalla direttiva 1999/5/CE.

Español

Por medio de la presente JVC KENWOOD declara que el DNN9230DAB cumple con los requisitos esenciales y cualesquiera otras disposiciones aplicables o exigibles de la Directiva 1999/5/CE.

Português

JVC KENWOOD declara que este DNN9230DAB está conforme com os requisitos essenciais e outras disposições da Directiva 1999/5/CE.

Polska

JVC KENWOOD niniejszym oświadcza, że DNN9230DAB spełnia zasadnicze wymogi oraz inne istotne postanowienia dyrektywy 1999/5/EC.

Český

JVC KENWOOD tímto prohlašuje, že DNN9230DAB je ve shodě se základními požadavky a s dalšími příslušnými ustanoveními Nařízení vlády č. 426/2000 Sb.

Magyar

Alulírott, JVC KENWOOD, kijelenti, hogy a jelen DNN9230DAB megfelel az 1999/5/EC irányelvben meghatározott alapvető követelményeknek és egyéb vonatkozó előírásoknak.

Svenska

Härmed intygar JVC KENWOOD att denna DNN9230DAB står i överensstämmelse med de väsentliga egenskapskrav och övriga relevanta bestämmelser som framgår av direktiv 1999/5/EG.

Suomi

JVC KENWOOD vakuuttaa täten että DNN9230DAB tyyppinen laite on direktiivin 1999/5/EY oleellisten vaatimusten ja sitä koskevien direktiivin muiden ehtojen mukainen.

Slovensko

S tem JVC KENWOOD izjavlja, da je ta DNN9230DAB v skladu z osnovnimi zahtevami in ostalimi ustreznimi predpisi Direktive 1999/5/EC.

Slovensky

Spoločnosť JVC KENWOOD týmto vyhlasuje, že DNN9230DAB spĺňa základné požiadavky a ďalšie príslušné ustanovenia Direktívy 1999/5/EC.

Dansk

Undertegnede JVC KENWOOD erklærer herved, at følgende udstyr DNN9230DAB overholder de væsentlige krav og øvrige relevante krav i direktiv 1999/5/EF.

Ελληνικά

ΜΕ ΤΗΝ ΠΑΡΟΥΣΑ JVC KENWOOD ΔΗΛΩΝΕΙ ΟΤΙ ΔΝΝ9230DAB ΣΥΜΜΟΡΦΩΝΕΤΑΙ ΠΡΟΣ ΤΙΣ ΟΥΣΙΩΔΕΙΣ ΑΠΑΙΤΗΣΕΙΣ ΚΑΙ ΤΙΣ ΛΟΙΠΕΣ ΣΧΕΤΙΚΕΣ ΔΙΑΤΑΞΕΙΣ ΤΗΣ ΟΔΗΓΙΑΣ 1999/5/ΕΚ.

Eesti

Sellela kinnitab JVC KENWOOD, et see DNN9230DAB vastab direktiivi 1999/5/EC põhilistele nõudmistele ja muudele asjakohastele määrustele.

Latviešu

Ar šo, JVC KENWOOD, apstiprina, ka DNN9230DAB atbilst Direktīvas 1999/5/EK galvenajām prasībām un citiem tās nosacījumiem.

Lietuviškai

Šiuo, JVC KENWOOD, pareiškia, kad šis DNN9230DAB atitinka pagrindinius Direktyvos 1999/5/EB reikalavimus ir kitas svarbias nuostatas.

Malti

Hawnhekk, JVC KENWOOD, jiddikjara li dan DNN9230DAB jikkonforma mal-ftiġġiet essenzjali u ma provvedimenti oħrajn relevanti li hemm fid-Direttiva 1999/5/EC.

Українська

Компанія JVC KENWOOD заявляє, що цей виріб DNN9230DAB відповідає ключовим вимогам та іншим пов'язаним положенням Директиви 1999/5/EC.

Norsk

JVC KENWOOD erklærer herved at enheten DNN9230DAB oppfyller grunnleggende krav og andre bestemmelser i direktiv 1999/5/EF.

Türkçe

Bu vesileyle JVC KENWOOD, DNN9230DAB ünitesinin, 1999/5/EC Direktifinin başlıca gereksinimleri ve diğer ilgili hükümleri ile uyumlu olduğunu beyan eder.

DAB+
Digital Audio Broadcasting



KENWOOD