

KENWOOD

DNN9230DAB

CONNECTED NAVIGATION SYSTEM
Quick Start Guide

JVC KENWOOD Corporation

About The Quick Start Guide

This Quick Start Guide explains the basic functions of this unit. For functions not covered in this guide, refer to the Instruction Manual (PDF file) contained in the included CD-ROM "Instruction Manual".

To refer to the Instruction Manual contained in the CD-ROM, a PC loaded with Microsoft® Windows XP/ Vista/7 or Mac OS X® 10.4 or later is required in addition to Adobe® Reader™ 7.1 or Adobe® Acrobat® 7.1 or later.

The Instruction Manual is subject to change for modification of specifications and so forth. You can download the latest version of the Instruction Manual from <http://manual.kenwood.com/edition/im365>.

NOTE

- The panels shown in this guide are examples used to provide clear explanations of the operations. For this reason, they may be different from the actual panels.
- In operation procedures, bracket shape indicates the key or button you should control.
 < >: indicates the name of panel buttons.
 []: indicates the name of touch keys.

Contents

Precautions	3
▲WARNING _____	3
Cleaning The Unit _____	4
How To Reset Your Unit _____	4
Safety Precautions and Important Information	5
▲WARNINGS _____	5
▲CAUTIONS _____	5
IMPORTANT INFORMATION _____	5
Features of Navigation systems	6
First Step	7
Basic Operations	10
Functions of the Buttons on the Front Panel _____	10
Common Operation _____	12
Detaching The Front Panel _____	13
Login	14
Operation on the Home Screen	14
How to Use the Navigation System	16
Other Features _____	18
How to Play Music	19
How to Play Movie	21
How to Listen to the Radio	22
How to Make a Phone Call	23
Installation Procedure	25
Before Installation _____	25
Installation Procedure _____	26
Removing Procedure _____	29
Connection _____	30
About This Unit _____	34

Precautions

⚠ WARNING

To prevent injury or fire, take the following precautions:

- To prevent a short circuit, never put or leave any metallic objects (such as coins or metal tools) inside the unit.
- Do not watch or fix your eyes on the unit's display when you are driving for any extended period.
- If you experience problems during installation, consult your Kenwood dealer.

Precautions on using this unit

- When you purchase optional accessories, check with your Kenwood dealer to make sure that they work with your model and in your area.
- You can select language to display menus, audio file tags, etc. See **Language setup (P.110)** in the Instruction Manual.
- The Radio Data System or Radio Broadcast Data System feature won't work where the service is not supported by any broadcasting station.

Protecting the monitor

To protect the monitor from damage, do not operate the monitor using a ballpoint pen or similar tool with the sharp tip.

Lens fogging

When you turn on the car heater in cold weather, dew or condensation may form on the lens in the disc player of the unit. Called lens fogging, this condensation on the lens may not allow discs to play. In such a situation, remove the disc and wait for the condensation to evaporate. If the unit still does not operate normally after a while, consult your Kenwood dealer.

Precautions on handling discs

- Do not touch the recording surface of the disc.
- Do not stick tape etc. on the disc, or use a disc with tape stuck on it.
- Do not use disc type accessories.
- Clean from the center of the disc and move outward.
- When removing discs from this unit, pull them out horizontally.
- If the disc center hole or outside rim has burrs, use the disc only after removing the burrs with a ballpoint pen etc.
- Discs that are not round cannot be used.

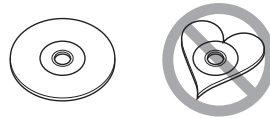

- 8-cm (3 inch) discs cannot be used.
- Discs with coloring on the recording surface or discs that are dirty cannot be used.
- This unit can only play the CDs with  This unit may not correctly play discs which do not have the mark.
- You cannot play a disc that has not been finalized. (For the finalization process see your writing software, and your recorder instruction manual.)

About the personal information stored in this unit

Before giving or selling this unit to others, be sure to delete the information (mail, search logs, etc.) stored in this unit by yourself and confirm that the data has been deleted.

We shall not be liable for any damage caused by leakage of undeleted data.

How to delete

1. Press the <HOME> button.
2. Press the <MENU> button.
3. Touch [Settings].
4. Touch [Backup & Reset].
5. Touch [Factory data reset].
6. Touch [Reset device].
7. Touch [Erase everything].

Acquiring GPS signal

The first time you turn on this unit, you must wait while the system acquires satellite signals for the first time. This process could take up to several minutes. Make sure your vehicle is outdoors in an open area away from tall buildings and trees for fastest acquisition. After the system acquires satellites for the first time, it will acquire satellites quickly each time thereafter.

About the front panel

When removing the product from the box or installing it, the front panel may be positioned at the angle shown in (Fig. 1). This is due to the characteristics of mechanism the product is equipped with.

When the product is first powered on works properly, the front panel will automatically move into the position (initial setting angle) shown in (Fig. 2).



(Fig. 1)

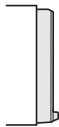

(Fig. 2)

Cleaning The Unit

If the faceplate of this unit is stained, wipe it with a dry soft cloth such as a silicon cloth. If the faceplate is stained badly, wipe the stain off with a cloth moistened with neutral cleaner, then wipe it again with a clean soft dry cloth.



- Applying spray cleaner directly to the unit may affect its mechanical parts. Wiping the faceplate with a hard cloth or using a volatile liquid such as thinner or alcohol may scratch the surface or erase screened print.

How To Reset Your Unit

If the unit or the connected unit fails to operate properly, reset the unit.

1 Press the <Reset> button.

The unit returns to factory settings.

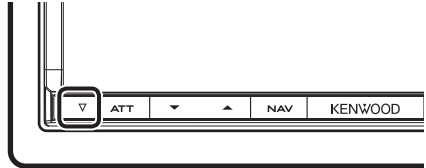

NOTE

- Disconnect the USB device before pressing the <Reset> button. Pressing the <Reset> button with the USB device connected can damage the data stored in the USB device. For how to disconnect the USB device, see **How to Play Music (P.19)**.
- When the unit is turned on after resetting, the Initial SETUP screen appears. See **First Step (P.7)**.

Safety Precautions and Important Information

Read this information carefully before starting to operate the Kenwood Car Navigation System and follow the instructions in this manual. Neither Kenwood nor Garmin shall be liable for problems or accidents resulting from failure to observe the instructions in this manual.

⚠️ WARNINGS

Failure to avoid the following potentially hazardous situations could result in an accident or collision resulting in death or serious injury.

When navigating, carefully compare information displayed on the navigation system to all available navigation sources, including information from street signs, visual sightings, and maps. For safety, always resolve any discrepancies or questions before continuing navigation.

Always operate the vehicle in a safe manner.

Do not become distracted by the navigation system while driving, and always be fully aware of all driving conditions. Minimize the amount of time spent viewing the screen of the navigation system while driving, and use voice prompts when possible.

Do not enter destinations, change settings, or access any functions requiring prolonged use of the navigation system controls while driving. Stop your vehicle in a safe and legal manner before attempting such operations.

Keep the system volume at a low enough level to be able to hear outside noises while driving. If you can no longer hear outside noises, you may be unable to react adequately to the traffic situation. This may cause accidents.

The navigation system will not display the correct current position of the vehicle the first time it is used after purchase, or if the vehicle battery is disconnected. GPS satellite signals will soon be received, however, and the correct position will be displayed.

Be careful of the ambient temperature. Using the navigation system at extreme temperatures can lead to malfunction or damage. Also note that the unit can be damaged by strong vibration, by metal objects, or by water getting inside the unit.

⚠️ CAUTIONS

Failure to avoid the following potentially hazardous situations may result in injury or property damage.

The navigation system is designed to provide you with route suggestions. It does not reflect road closures or road conditions, weather conditions, or other factors that may affect safety or timing while driving.

Use the navigation system only as a navigational aid. Do not attempt to use the navigation system for any purpose requiring precise measurement of direction, distance, location, or topography.

The Global Positioning System (GPS) is operated by the United States government, which is solely responsible for its accuracy and maintenance. The government system is subject to changes that could affect the accuracy and performance of all GPS equipment, including the navigation system. Although the navigation system is a precision navigation device, any navigation device can be misused or misinterpreted and, therefore, become unsafe.

IMPORTANT INFORMATION

Vehicle Battery Preservation

This navigation system can be used when the ignition key is turned to ON or ACC. To preserve the battery, however, it should be used with the engine running whenever possible. Using the navigation system for a long time with the engine switched off can cause the battery to run down.

Map Data Information

One of the goals of Garmin is to provide customers with the most complete and accurate cartography that is available to us at a reasonable cost. We use a combination of governmental and private data sources, which we identify in product literature and copyright messages displayed to the consumer. Virtually all data sources contain some inaccurate or incomplete data. In some countries, complete and accurate map information is either not available or is prohibitively expensive.

Features of Navigation systems

By connecting this navigation system to Internet, you can use various services.



Cooperation with Route Collector site

- Destinations and routes specified on the PC can be input to this navigation system.
- The routes you have traveled and the songs you have listened to can be logged.
- By uploading music files to Dropbox and creating a play list on Route Collector site, you can listen to music anywhere through streaming without music files on this navigation system.
- Speech to Text (STT) and Text to Speech (TTS).



Use of internet service

- Streaming service such as YouTube, Aupeol.
- Internet service such as email, Gmail, Google calendar, and social networking service such as Facebook and Twitter.
- Information (weather, traffic, RSS, etc.) service.

3G, LTE or EDGE

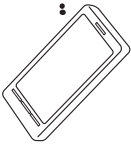

Wi-Fi access point

- Connect to Internet using the tethering function of your smartphone or an Internet device.



Wi-Fi (11n/g/b)



About the account

- To use internet services via this system, you need to create an account in the Route Collector site.
- In addition to the owner account, you can register up to four user accounts.
- You can use a guest account as well.
- By switching among accounts, you can secure the privacy when using the mail feature or social media.

Notes

You can use following feature for 2 years after registration of the owner account. To use it continuously, a usage fee is required. For details, see web site of Route Collector. <http://www.route-collector.com/>

- Weather (by INRIX)
- Traffic (by INRIX)
- Dynamic Parking (by INRIX)
- Fuel Prices (by INRIX)
- Real-Time Traffic Camera (by INRIX)
- Movie Show Times (by WWM)
- TTS (by Nuance)
- STT (by Nuance)

To use the following services, you need to register the corresponding free or paid accounts.

- Aupeol
- Facebook
- Twitter
- Gmail (by Google)
- Google calendar (by Google)
- Dropbox

First Step

Power on the unit and perform some setup steps before using.

Press the <⏻HOME> button.

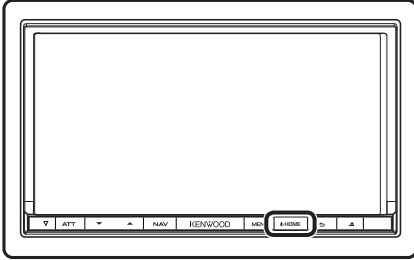

The navigation system is turned on.

● To turn off the navigation system:

Press the <⏻HOME> button for 1 second.

The "Initial setup" is only necessary when you use the navigation system for the first time after purchase, or when you reset the unit.

1 Touch the corresponding key and set the item.



Language Setup

Select the language used for the GUI and input methods. Default is "English (United States)".

① Touch [Language Setup].

② Select a language from the list.

After setting, press the <⏻> button twice.

WiFi Setup

Configure settings for connection to Wi-Fi.

① Touch [WiFi Setup].

② Slide Wi-Fi to ON.

③ Select the Wi-Fi access point to register from the list.

④ Input the Password.

⑤ Touch [Connect].

After setting, press the <⏻> button.

Date Setup

Set the date and time.

① Touch [Date Setup].

② Touch [Select time zone].

③ Select a time zone.

After setting, press the <⏻> button.

Account Setup

Set the information about the user of this navigation system.

① Touch [Account Setup].

See **Types of accounts, Create User Account** and **Set Owner Account**.

● Types of accounts

Administrator

As Administrator, you can create an owner account and perform initial setup.

You can log in to the system if you have not created an owner account.

Guest

An account for guests such as your friends.

The guest can operate this unit, but cannot use the functions related to mail, social media, and Route Collector site.

Owner

The account for the person who manages this unit.

The owner can use the functions related to mail, social media, and Route Collector site.

You can register users such as your family.

User

The account for the user of this unit.

The user can use the functions related to mail, social media, and Route Collector site.

You can register up to 4 user accounts.

● Create User Account

Preparation

- To register yourself in the Route Collector site as a user, you need a mail address.
- You can register yourself via the Web.
<http://www.route-collector.com/>
- This step may be skipped if you have already registered yourself in the Route Collector site.

- 1) Touch [Create Account].
- 2) Enter account information.
You cannot register an account which has already been used. Register another account name.
- 3) Touch [OK].
The account is temporarily registered in the Route Collector site.
- 4) Activate the account.
A confirmation mail is sent to the registered mail address. Open the indicated URL to complete account registration.

● Set Owner Account

- 1) Touch [Set Owner Account].
- 2) Enter account information.
Enter the information registered in the Route Collector site.
- 3) Touch [OK].

2 Touch [Next].

3 Touch the corresponding key and set the item.



Language

Select the language used for the control screen and setting items. Default is "American English (en)".

After setting, touch [Enter].

Angle

Adjust the position of the monitor. Default is "0".

After setting, touch [↩].

iPod AV Interface Use

Set the terminal which your iPod is connected to. Default is "iPod".

Color

Set the screen and button illumination color. You can select whether to perform color scan and adjust scanning color.

After setting, touch [↩].

Camera

Set the parameters for the camera.

After setting, touch [].

Demo mode

Set the demonstration mode. Default is "ON".

4 Touch [Finish].

NOTE

- For details on operations of each setting, refer to the Instruction Manual.

5 Touch [Administrator].

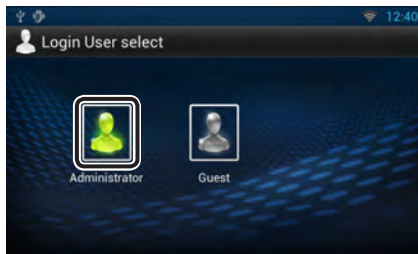

How to prepare the remote control

Insert two "AAA"/"R03"-size batteries with the ⊕ and ⊖ poles aligned properly, following the illustration inside the case.

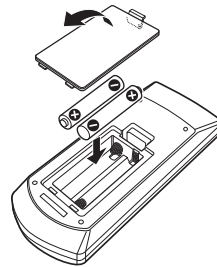
**⚠ CAUTION**

- Put the remote controller in a place where it will not move during braking or other operations. A dangerous situation could result, if the remote controller falls down and gets wedged under the pedals while driving.
- Do not leave the battery near fire or under direct sunlight. A fire, explosion or excessive heat generation may result.
- Do not recharge, short, break up or heat the battery or place it in an open fire. Such actions may cause the battery to leak fluid. If spilled fluid comes in contact with your eyes or on clothing, immediately rinse with water and consult a physician.
- Place the battery out of reach of children. In the unlikely event that a child swallows the battery, immediately consult a physician.

Basic Operations

Functions of the Buttons on the Front Panel

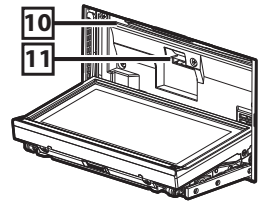
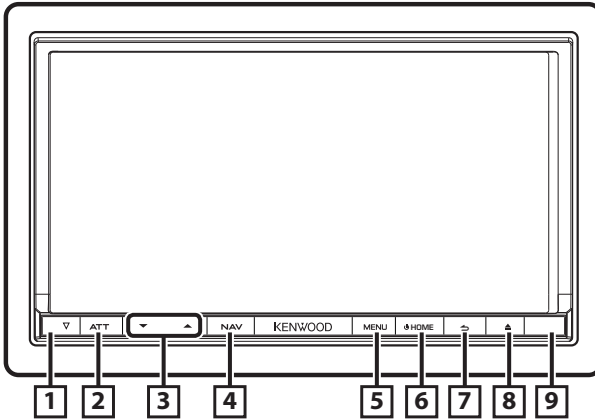

How to insert an SD card

- 1) Press **8** <▲> button for 1 second.
The panel fully opens.
- 2) Hold the SD card as the illustration in the right and insert it into the slot until it clicks.

● To eject the card:

Push the card until it clicks and then remove your finger from the card.
The card pops up so that you can pull it out with your fingers.

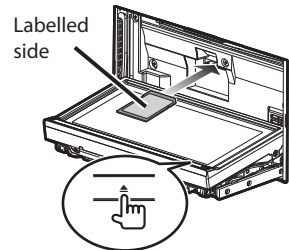

Number	Name	Motion
1	▽ (Reset)	<ul style="list-style-type: none"> • If the unit or the connected unit fails to operate properly, the unit returns to initial settings when this button is pressed (Instruction Manual P.135). • If the SI function is turned on, this indicator flashes when the vehicle ignition is off (Instruction Manual P.110).
2	ATT	<ul style="list-style-type: none"> • Switches attenuation of the volume on/off. • Pressing for 1 second turns the screen off.
3	▼, ▲ (Vol)	Adjusts volume.
4	NAV	<ul style="list-style-type: none"> • Displays the navigation screen. • Pressing for 1 second switches camera view display on/off.
5	MENU	<ul style="list-style-type: none"> • Displays the option menu screen. • Pressing for 1 second switches AV out sources.
6	HOME	<ul style="list-style-type: none"> • Displays the Home screen (P.14). • Pressing for 1 second turns the power off. • When the power off, turns the power on.
7	↶ (Back)	<ul style="list-style-type: none"> • Return to the previously viewed screen. • Pressing for 1 second displays the Hands Free screen (Instruction Manual P.98).
8	▲ (Eject)	<ul style="list-style-type: none"> • Ejects the disc. • When the panel is opened, pressing closes the panel and pressing for 1 second ejects the disc forcibly. • When the panel is closed, pressing for 1 second fully opens the panel to the location of the SD card slot.
9	Remote Sensor	Receives the remote control signal.
10	Disc insert slot	A slot to insert a disc media.
11	SD card slot	A slot to insert an SD card.

Common Operation

General

There are some functions which can be operated from most screens.

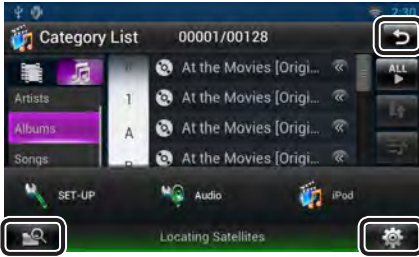

List screen

There are some common function keys in the list screens of most sources.

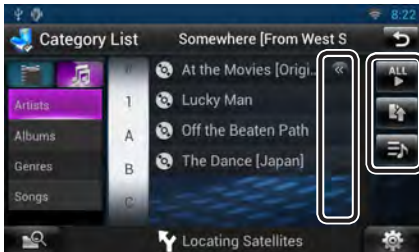

Flick scrolling

You can scroll the list screen by flicking the screen up/down or right/left.

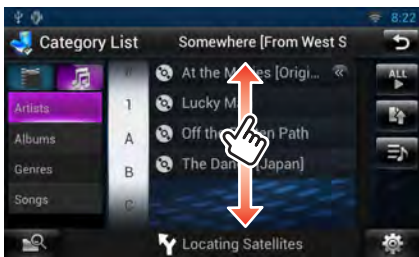

(Mixed Media Search)

Touch to display the Mixed Media Search screen.

(Quick menu)

Touch to display the quick menu. The content of the menu are as follows.

- : Displays the SETUP Menu screen.
- : Displays the Audio Control Menu screen.
- : Displays the control screen of current source. Icon feature differs depending on the source.

(RETURN)

Returns to previous screen.

(Scroll)

Touch to scroll through texts on the display.

ALL etc.

Touch keys with various functions are displayed here.

Displayed keys differ depending on the current audio source, status, etc.

For examples, see **List screen (P.24)** in the Instruction Manual.

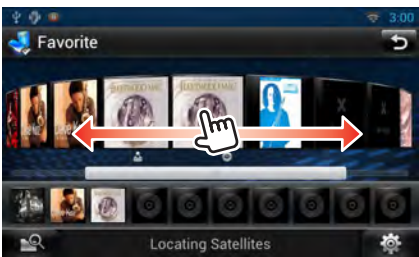

Detaching The Front Panel

You can detach the front panel to prevent theft.

Press the <▲> button for 1 second to open the front panel.

Then, detach the panel as the diagrams below.

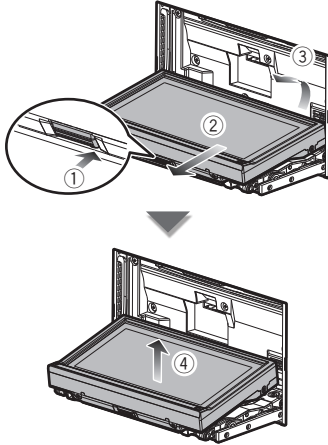

● After detaching

Put the panel in the protective bag supplied with the unit.

NOTE

- The attaching plate closes automatically in about 10 seconds after the front panel is released. Remove the panel before this happens. To prevent deterioration, do not touch the terminals of the unit and faceplate with your fingers.
- If the terminals on the unit or faceplate get dirty, wipe them with a clean soft dry cloth.
- For attaching the panel, see **Attaching the front panel (P.27)**.

Login

- 1 Press the <HOME> button to turn the power on.
- 2 Select the login user.
- 3 Enter the password.



(Password)

Enter the registered password.
If you selected Administrator or Guest, this screen is not displayed.

[Auto Login?]

Checking this checkbox allows you to log in to the system automatically from the next time.

[Login]

Log in to the system.

NOTE

- If you forgot your password, create your new password on the Route Collector site. <http://www.route-collector.com/>

Operation on the Home Screen

- 1 Press the <HOME> button to display the Home screen.
- 2 Select the Service panel, Media panel, Source launcher panel, or Network contents panel.

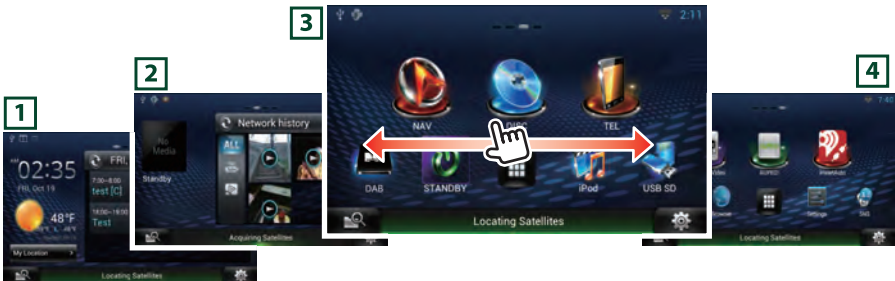

Panel	Description
1 Service panel	Weather widget: Displays the weather forecast for the selected region. Network widget: Displays the schedule, SNS, or RSS.
2 Media panel	Now playing: Displays the title of the song being played or the name of the station you are listening to, and allows you to perform simple operations. Media widget: Allows you to switch among Network media history for selecting a song from the history of the songs you listened to, Photo frame for displaying a photo, and Network search for searching for a song related to a keyword.

3] Source launcher panel	Allows you select a source.
4] Network contents panel	Allows you to select a network-related application.

Source launcher panel



● All source list



● Moving or deleting of an icon on the Source launcher panel

- 1) Touch and hold the icon.
- 2) Drag the icon to the desired position or Recycle Bin.



● Adding of a shortcut icon to Source launcher panel

- 1) Touch [] in Source launcher panel.
- 2) Touching the icon continuously to display the Source launcher panel screen.
- 3) Drag the icon to an empty space.

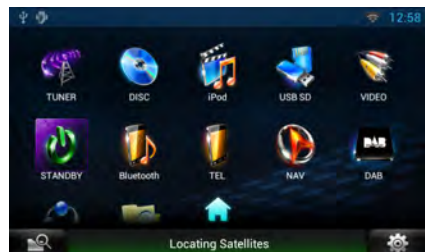

(Shortcut)

You can register sources you use frequently so that you can start them quickly.

(All source list)

Displays all sources.

(All source list)

You can scroll the list screen by flicking the screen up/down.

(Home)

Returns to the Source launcher panel.

How to Use the Navigation System

1 Press the <NAV> button to display the navigation screen.

2 Operate the desired function from the Main Menu screen.



1	GPS satellite strength.
2	Finds a destination.
3	Views the map.
4	Uses the Apps such as ecoRoute and Help.
5	Adjusts the settings.

NOTE

• You can get additional information about using the navigation system from Help. To display Help, touch [Apps] and then touch [Help].

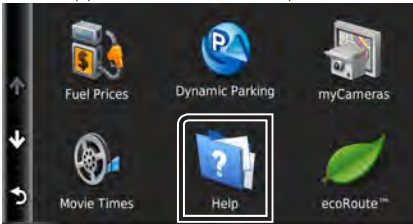

• For more information about your navigation system, download the latest version of the Owner's Manual from manual.kenwood.com/edition/im365

3 Enter your destination and start the guidance.

● **Finding points of interest**

- 1) Touch [Where To?].
- 2) Select a category and a subcategory.
- 3) Select a destination.
- 4) Touch [Go!].

NOTE

• To enter letters contained in the name, touch the Search bar and enter the letters.

4 Follow your route to the destination.

NOTICE

- The speed limit icon feature is for information only and does not replace the driver's responsibility to abide by all posted speed limit signs and to use safe driving judgment at all times. Garmin and JVC KENWOOD will not be responsible for any traffic fines or citations that you may receive for failing to follow all applicable traffic laws and signs.

Your route is marked with a magenta line. As you travel, your navigation system guides you to your destination with voice prompts, arrows on the map, and directions at the top of the map. If you depart from the original route, your navigation system recalculates the route.



1	Views the Next Turn page or the junction view page, when available.
2	Views the Turn List page.
3	Views the Where Am I? page.
4	Stops the current route.
5	Displays traffic information on the route.
6	Returns to the Main Menu.
7	Displays a different data field.
8	Views the Trip Computer.
9	Displays more options.



NOTE

- Touch and drag the map to view a different area of the map.
- A speed limit icon could appear as you travel on major roadways.

● Adding a stop

- 1) While navigating a route, touch [] and then touch [Where To?].
- 2) Search for the extra stop.
- 3) Touch [Go!].
- 4) Touch [Add to Active Route] to add this stop before your final destination.

● Taking a detour

- 1) While navigating a route, touch [].
- 2) Touch [].

Continued

Other Features

● Manually avoiding traffic on your route

- 1) From the map, touch the traffic icon.
- 2) Touch [Traffic On Route].
- 3) If necessary, touch the arrows to view other traffic delays on your route.
- 4) Touch [] > [Avoid].

● Viewing the traffic map

The traffic map shows color-coded traffic flow and delays on nearby.

● About traffic

NOTICE

- Traffic service is not available in some areas or countries.
- Garmin and JVC KENWOOD are not responsible for the accuracy or timeliness of the traffic information.
- Your navigation system can receive traffic information using the built-in traffic receiver or a subscription to INRIX Traffic Service. The traffic receiver must be in data range of a station transmitting traffic data to receive traffic information. The traffic subscription activates automatically after your navigation system acquires satellite signals while receiving traffic signals from the service provider. You can add other subscriptions at any time. For information about traffic receivers and coverage areas, go to www.garmin.com/kenwood.

● Updating the software

To update the navigation system software, you must have a USB mass storage device and an internet connection.

- 1) Go to www.garmin.com/Kenwood.
- 2) Find your model and select [Software Updates] > [Download].
- 3) Read and accept the terms of the Software License Agreement.
- 4) Follow the instructions on the Web site to complete the installation of the software update.

● Updating maps

You can purchase updated map data from Garmin or ask your Kenwood dealer or Kenwood service center for details.

- 1) Go to www.garmin.com/Kenwood.
- 2) Select [Order Map Updates] for your Kenwood unit.
- 3) Follow the Web site instructions to update your map.

How to Play Music

You can play audio files from music CD, disc media, USB storage device and iPod.

NOTE

• For details on playable file format, media format, iPod model, etc., refer to the Instruction Manual.

1 Connect the media you want to play as shown below.

Disc

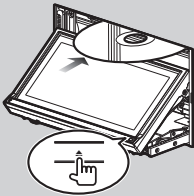

- 1) Press the <▲> button to open the front panel.
- 2) Insert the disc into the slot.

→ *The panel closes automatically and playback starts.*

● To eject the disc:

Press the <▲> button.

iPod, USB device

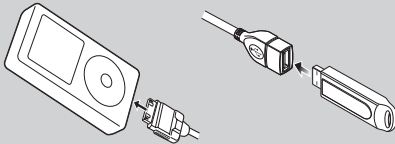

- 1) Connect the device with each cable.

→ *Playback starts.*

● To disconnect the device:

Touch [◀] on the screen and then touch [▲].

Disconnect the device from the cable.

SD card

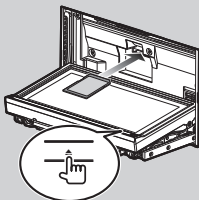

- 1) Press the <▲> button for 1 second to open the front panel.

- 2) Hold the SD card as the diagram below and insert it into the slot until it clicks.

→ *Playback starts.*

● To remove:

Push the card until it clicks and then remove your finger from the card.

The card pops up so that you can pull it out with your fingers.

2 Control the music you are listening to on the source control screen.

The following symbols indicate the keys on the screen.

The functions of the keys are the same despite the difference of the source you are listening to.

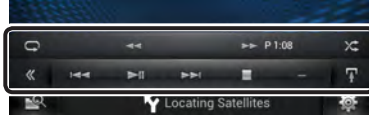

Basic operations from this screen

Plays or pauses:	▶▶
Stops playing:	■
Disconnects the device:	▲
Searches the previous/next content:	◀◀▶▶
Fast forwards or Fast backwards (Disc media, CD, USB device, SD card only):	◀◀▶▶ or move the cursor in the center bar
Repeats current content:	🔄
Plays all content in random order:	🎲

NOTE

- For other operations, refer to the Instruction Manual.
- If desired key is not displayed in the multi-function bar, touch the [◀] to switch the menu.

3 Search the track/file you want to listen to.

● List search

- 1) Touch center of the screen.

The content list of the media being played is displayed.

If the information of the current track only is displayed, touch and hold [⏮] to switch the list display.

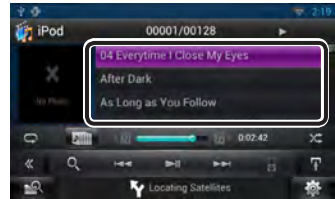

● Refined search

- 1) Touch [Q].
- 2) Touch the desired refinement method.
The list is refined by the item you selected.
- 3) Touch the desired item.

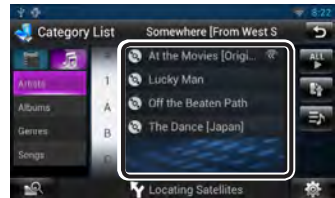

NOTE

- For details on searching operations, refer to **Search Operation (P.68)** in the Instruction Manual.

How to Play Movie

You can play DVD video, Video CD (VCD), movie files from disc media, iPod and USB storage device.

NOTE

- For details on playable file format, device format, etc., refer to the Instruction Manual.

1 Connect the media you want to play.

For the method of connecting, see **How to Play Music (P.19)**.

2 Control the movie by touching the screen.

Each area on the screen has a separate function.



1	2	3
Displays the movie control screen.	Displays the Source Control screen.	<ul style="list-style-type: none"> • Searches the next/previous content or file. • Scrolling from center of display to left or right performs fast backward or fast forward. To stop fast backward/forward, touch center of the display.*¹

*¹ For iPod/USB, this function may be unavailable depending on the playing file format.

NOTE

- For operations on the source control screen, see **How to Play Music (P.19)**. However, searching by category/link/album artwork is not available.

How to Listen to the Radio

1 Press the <HOME> button twice to the Source launcher panel.

2 Touch [] in the Source launcher panel.

3 Touch [TUNER].

The unit switches to the Radio tuner source.

4 Operate on the source control screen.

● **Station search**

1) Touch [].

Sub function menu appears.

2) Touch [AM] or [FM] to select the band.

3) Touch [◀◀] or [▶▶] to tune in the desired station.

● **Auto memory**

1) Touch [].

Sub function menu appears.

2) Touch [AM] or [FM] to select the band.

3) Touch [].

4) Touch [AME].

5) Touch [◀◀] or [▶▶] in the sub function menu.

Auto memory starts.

● **Recalling the preset station**

1) Touch [P#].

You can also display the preset list by touching the frequency display in the center.

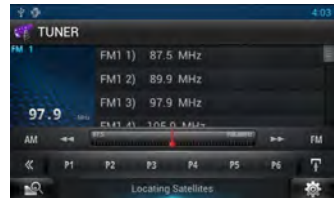

NOTE



• For other operations, see **Radio Basic Operation (P.80)** in the Instruction Manual.

How to Make a Phone Call

You can use your Bluetooth cell-phone when paired to this unit.

1 Register your cell-phone to the unit.

Follow as the procedures shown below. For detailed operation, see **Registering the Bluetooth Unit (P.95)** in the Instruction Manual.

- 1) Press and hold the <  > button.
- 2) Touch [].

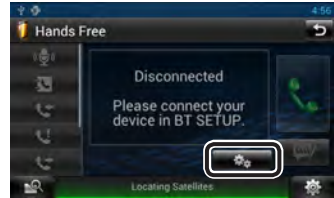

- 3) Touch [PIN Code Set] in the Searched Device List screen.
- 4) Enter PIN code and touch [Enter].
- 5) Select your cell-phone from the displayed list in the Searched Device List screen.

Registering is completed.

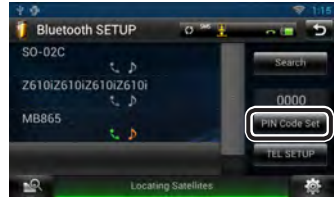

2 Connect your cell-phone to the unit.

- 1) Touch the desired device from the list and touch [TEL(HFP)].
The selected device is connected to the unit.



NOTE

- Touch [Audio(A2DP)] if you want to connect the device as an audio player.

3 Download your phonebook.

- 1) Operate the cell-phone to send the phonebook data to this unit.
- 2) Operate the cell-phone to start the hands-free connection.

NOTE

- See the instruction manual of your cell-phone for the operation.

4 Make or receive a phone call.

See the table below for each operation method.



Call by entering a phone number

- ① Touch [].
- ② Enter a phone number with number keys.
- ③ Touch [].

Call using call records

- ① Touch [] (Incoming Calls), [] (Outgoing Calls), or [] (Missed Calls).
- ② Select the phone number from the list.
- ③ Touch [].

Call using the phonebook

- ① Touch [].
- ② Select the name from the list.
- ③ Select the number from the list.
- ④ Touch [].

Call using the preset number

- ① Touch [Preset #] to start calling the corresponding phone number.

Call by voice

You can make a voice call using the voice recognition function of the cell-phone.

- ① Touch [].
- ② Pronounce the name registered in the cell-phone.

NOTE

- For detailed operation, see **Using Hands-Free Feature (P.98)** in the Instruction Manual.

Installation Procedure

Before Installation

Before installation of this unit, please note the following precautions.

⚠️ WARNINGS

- If you connect the ignition wire (red) and the battery wire (yellow) to the car chassis (ground), you may cause a short circuit, that in turn may start a fire. Always connect those wires to the power source running through the fuse box.
- Do not cut out the fuse from the ignition wire (red) and the battery wire (yellow). The power supply must be connected to the wires via the fuse.

⚠️ CAUTION

- Install this unit in the console of your vehicle.
Do not touch the metal part of this unit during and shortly after the use of the unit. Metal part such as the heat sink and enclosure become hot.

NOTES

- Mounting and wiring this product requires skills and experience. For best safety, leave the mounting and wiring work to professionals.
- Make sure to ground the unit to a negative 12V DC power supply.
- Do not install the unit in a spot exposed to direct sunlight or excessive heat or humidity. Also avoid places with too much dust or the possibility of water splashing.
- Do not use your own screws. Use only the screws provided. If you use the wrong screws, you could damage the unit.
- If the power is not turned ON ("PROTECT" is displayed), the speaker wire may have a short-circuit or touched the chassis of the vehicle and the protection function may have been activated. Therefore, the speaker wire should be checked.
- If your car's ignition does not have an ACC position, connect the ignition wires to a power source that can be turned on and off with the ignition key. If you connect the ignition wire to a power source with a constant voltage supply, such as with battery wires, the battery may be drained.

- If the console has a lid, make sure to install the unit so that the faceplate will not hit the lid when closing and opening.
- If the fuse blows, first make sure the wires aren't touching to cause a short circuit, then replace the old fuse with one with the same rating.
- Insulate unconnected wires with vinyl tape or other similar material. To prevent a short circuit, do not remove the caps on the ends of the unconnected wires or the terminals.
- Connect the speaker wires correctly to the terminals to which they correspond. The unit may be damaged or fail to work if you share the ⊖ wires or ground them to any metal part in the car.
- When only two speakers are being connected to the system, connect the connectors either to both the front output terminals or to both the rear output terminals (do not mix front and rear). For example, if you connect the ⊕ connector of the left speaker to a front output terminal, do not connect the ⊖ connector to a rear output terminal.
- After the unit is installed, check whether the brake lamps, blinkers, wipers, etc. on the car are working properly.
- Mount the unit so that the mounting angle is 30° or less.
- This unit has the cooling fan (**P.30**) to decrease the internal temperature. Do not mount the unit in a place where the cooling fan of the unit are blocked. Blocking these openings will inhibit the cooling of the internal temperature and result in malfunction.
- Do not press hard on the panel surface when installing the unit to the vehicle. Otherwise scars, damage, or failure may result.
- Reception may drop if there are metal objects near the Bluetooth antenna and WI-FI receiver.

Bluetooth antenna area

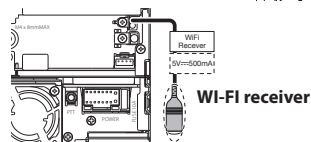







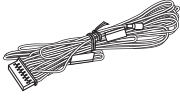
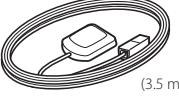
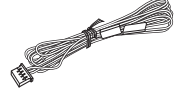

- Install the WI-FI receiver besides the place enclosed by the metal.

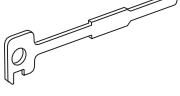
Installation Procedure

Supplied accessories

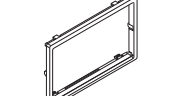
First of all, make sure that all accessories are supplied with the unit.

① ...1 	⑥ ...1  (3.5 m)
② ...1 	⑦ ...1 
③ ...2 	⑧ ...1  (3 m)
④ ...1 	⑨ ...1  (3 m)
⑤ ...1 	⑩ ...1 

Unit

- 1 To prevent a short circuit, remove the key from the ignition and disconnect the \ominus terminal of the battery.
- 2 Make the proper input and output wire connections for each unit.
- 3 Connect the wire on the wiring harness.
- 4 Take Connector B on the wiring harness and connect it to the speaker connector in your vehicle.
- 5 Take Connector A on the wiring harness and connect it to the external power connector on your vehicle.
- 6 Connect the wiring harness connector to the unit.
- 7 Install the unit in your car.
- 8 Reconnect the \ominus terminal of the battery.
- 9 Press the <Reset> button. **(P.4)**
- 10 Perform the Initial Setup. See **First Step (P.7)**.

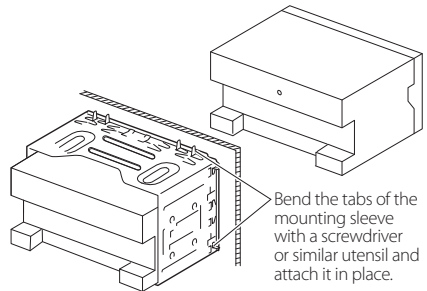

NOTE

- Make sure that the unit is installed securely in place. If the unit is unstable, it may malfunction (eg, the sound may skip).

Attaching the front panel

Hold the front panel securely so as not to drop it accidentally. Fit the panel onto the attaching plate until it is firmly locked.

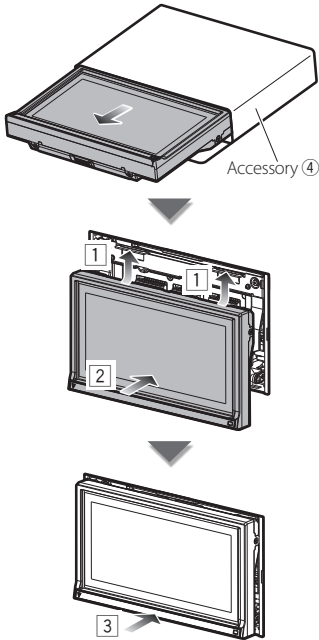

Trim plate

Attach accessory ⑤ to the unit.

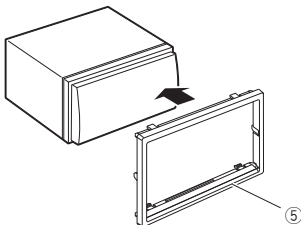

GPS antenna

GPS antenna is installed inside of the car. It should be installed as horizontally as possible to allow easy reception of the GPS satellite signals.

To mount the GPS antenna inside your vehicle:

- 1) Clean your dashboard or other surface.
- 2) Remove the separator of the metal plate (accessory ⑦).
- 3) Press the metal plate (accessory ⑦) down firmly on your dashboard or other mounting surface. You can bend the metal plate (accessory ⑦) to conform to a curved surface, if necessary.
- 4) Remove the separator of the GPS antenna (accessory ⑥), and stick the antenna to the metal plate (accessory ⑦).

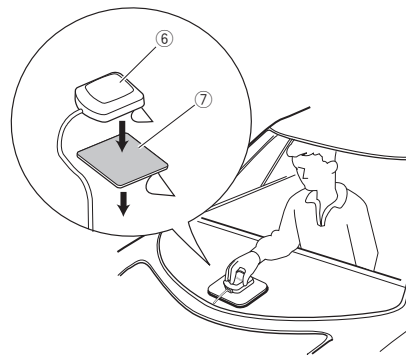

- Depending on the type of car, reception of the GPS satellite signals might not be possible with an inside installation.
- The GPS antenna should be installed at a position that is spaced at least 12 inch (30 cm) from cellular phone or other transmitting antennas. Signals from the GPS satellite may be interfered with by these types of communication.
- Painting the GPS antenna with (metallic) paint may cause a drop in performance.

Microphone unit and Push-To-Talk Switch

- 1) Check the installation position of the microphone (accessory ⑧) and the Push-To-Talk switch (accessory ⑨).
- 2) Clean the installation surface.
- 3) Install the microphone.
- 4) Wire the microphone cable up to the unit with it secured at several positions using tape or other desired method.

NOTE

- Install the microphone as far as possible from the cell-phone.

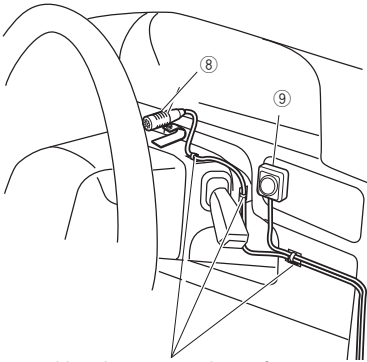

Fix a cable with a commercial item of tape.

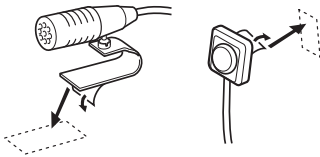

Remove the separator of the microphone, and stick the microphone to the place shown above.



Adjust the direction of the microphone to the driver.

Removing Procedure

Removing the trim plate

- 1) Engage the catch pins on the extraction key (accessory ③) and remove the two locks on the lower level.
Lower the frame and pull it forward as shown in the figure.

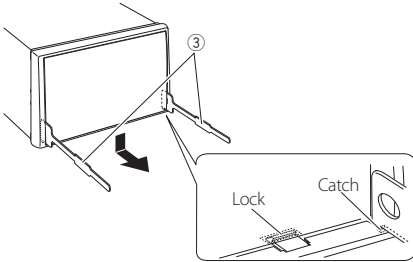

NOTE

- The trim plate can be removed from the top side in the same manner.

- 2) When the lower level is removed, remove the upper two locations.

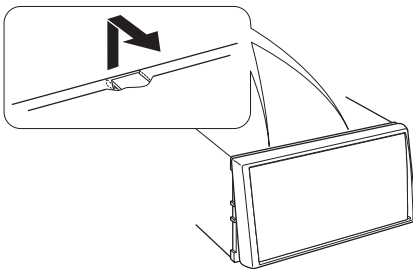

Removing the unit

- 1) Remove the trim plate by referring to **step 1** in "Removing the trim plate".
- 2) Insert the two extraction keys (accessory ③) deeply into the slots on each side, as shown.

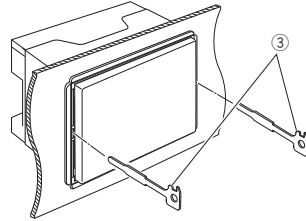

- 3) Lower the extraction key toward the bottom, and pull out the unit halfway while pressing towards the inside.

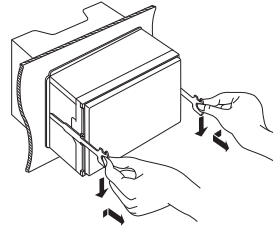

NOTE

- Be careful to avoid injury from the catch pins on the extraction key.

- 4) Pull the unit all the way out with your hands, being careful not to drop it.

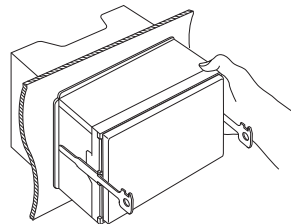

Connection

System connection

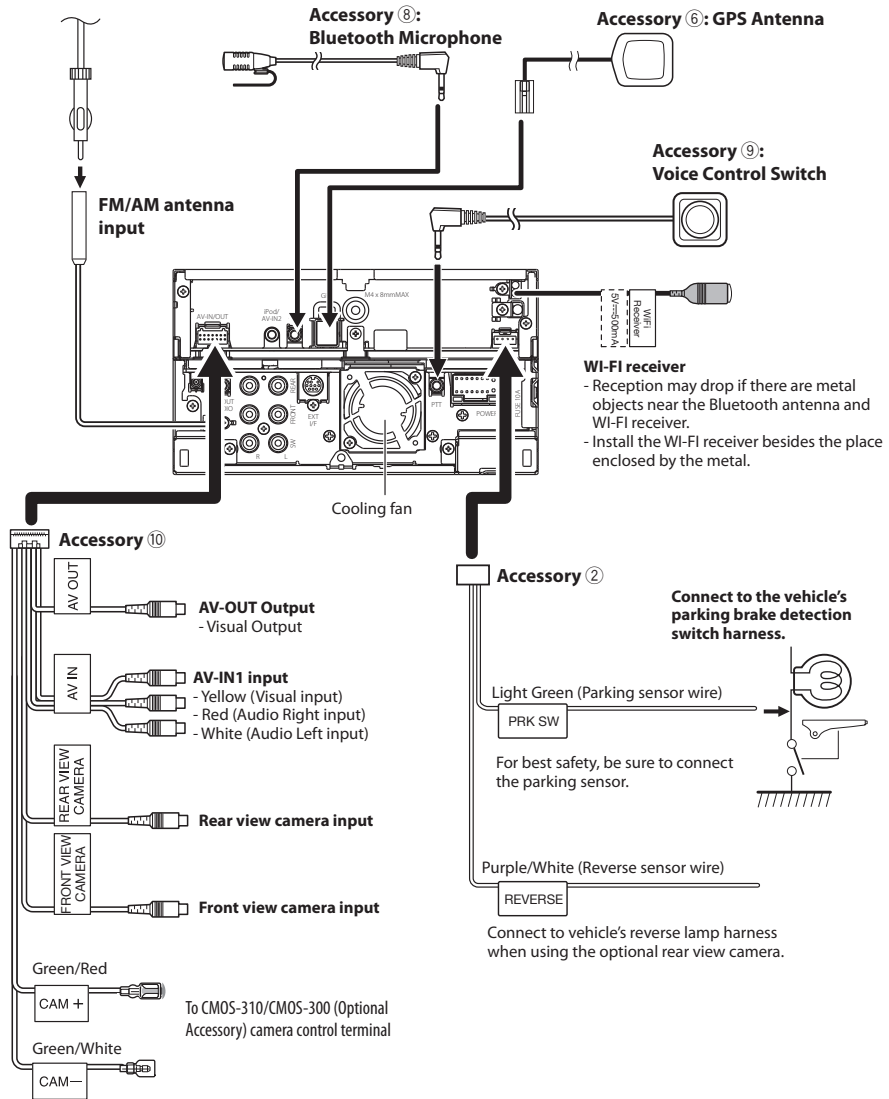

Optional accessory connection

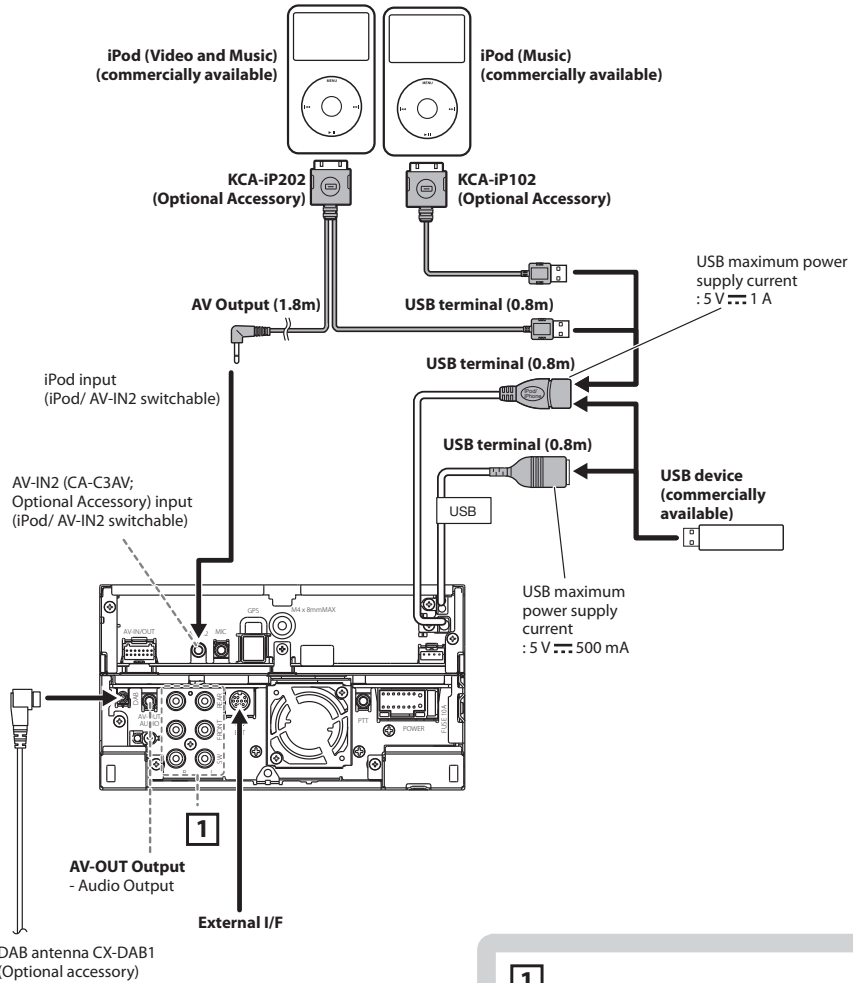

Use of a CX-DAB1 (optional accessory) as a DAB antenna is recommended. When using a commercially available DAB antenna, the diameter of the SMB connector must be $\Phi 6.5$ mm or less.

$\Phi 6.5$ mm (maximum)

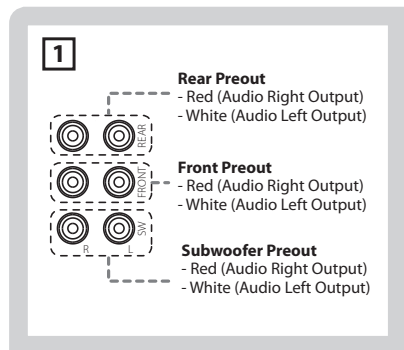
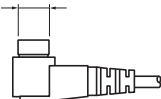

About This Unit

■ Copyrights

- The Bluetooth word mark and logos are owned by the Bluetooth SIG, Inc. and any use of such marks by JVC KENWOOD Corporation is under license. Other trademarks and trade names are those of their respective owners.
- The "AAC" logo is a trademark of Dolby Laboratories.
- "Made for iPod" and "Made for iPhone" mean that an electronic accessory has been designed to connect specifically to iPod or iPhone, respectively, and has been certified by the developer to meet Apple performance standards. Apple is not responsible for the operation of this device or its compliance with safety and regulatory standards. Please note that the use of this accessory with iPod or iPhone may affect wireless performance.
- iPhone, iPod, iPod classic, iPod nano, and iPod touch are trademarks of Apple Inc., registered in the U.S. and other countries.
-  is a trademark of DVD Format/Logo Licensing Corporation registered in the U.S., Japan and other countries.
- This item incorporates copy protection technology that is protected by U.S. patents and other intellectual property rights of Rovi Corporation. Reverse engineering and disassembly are prohibited.
- Manufactured under license from Dolby Laboratories. Dolby and the double-D symbol are trademarks of Dolby Laboratories.
- Manufactured under license under U.S. Patent Nos: 5,956,674; 5,974,380; 6,487,535 & other U.S. and worldwide patents issued & pending. DTS, the Symbol, & DTS and the Symbol together are registered trademarks & DTS 2.0 Channel is a trademark of DTS, Inc. Product includes software. © DTS, Inc. All Rights Reserved.
- Adobe, Acrobat and Reader are either registered trademarks or trademarks of Adobe Systems Incorporated in the United States and/or other countries.
- Google, the Google logo, Android, Gmail, and YouTube are trademarks of Google Inc.
- SDHC Logo is a trademark of SD-3C, LLC.
- Twitter is a registered trademark of Twitter, Inc.
- Facebook® is a registered trademark of Facebook Inc.
- INRIX is a registered trademark of INRIX, Inc.
- Nuance is a registered trademark of Nuance Communications, Inc.
- "aupeo" is a trade mark of Aupeo Ltd.
- Dropbox is a trademark of Dropbox Inc.

- ABOUT DIVX VIDEO: DivX® is a digital video format created by DivX, LLC, a subsidiary of Rovi Corporation. This is an official DivX Certified® device that plays DivX video. Visit divx.com for more information and software tools to convert your files into DivX videos.
- ABOUT DIVX VIDEO-ON-DEMAND: This DivX Certified® device must be registered in order to play purchased DivX Video-on-Demand (VOD) movies. To obtain your registration code, locate the DivX VOD section in your device setup menu. Go to vod.divx.com for more information on how to complete your registration.
- DivX®, DivX Certified® and associated logos are trademarks of Rovi Corporation or its subsidiaries and are used under license.

■ KENWOOD Route Network Service "Route Collector" User's Agreement

This KENWOOD Route Network Service "Route Collector" User's Agreement ("Agreement") sets forth the terms and conditions for use of the KENWOOD Route Network Service "Route Collector" provided by JVC KENWOOD Corporation ("Service") to the users who fulfill the requirements for "Conditions of Use" in the paragraph 1 ("User(s)"), and the rules for handling User's information necessary for use this Service.

1. Conditions of Use

Users who desire to take advantage of this Service must however first register themselves upon agreeing to the terms of this Agreement. This Service may only be used by Users for personal use, not for commercial use.

The terms of this Agreement may be revised or modified as necessary at our option without prior notice. In such event, Users shall hereby agree to the application of any such revisions or modifications as a condition to continued use of the Service.

Also, Users shall be solely responsible for managing and using their registered user account names and passwords. In no event can we accept any responsibility for any problems or damages resulting from the User's management and usage of its user account name and password management.

2. Period for the Service

Users may in principal continue to use the Service as long as it is being provided by us. However, the Service may be changed, suspended or cancelled at our option without prior notice.

3. Disclaimer

The User shall undertake use of the Service at its own individual responsibility, and accordingly we shall not assume any responsibility for usage of the Service by the User, including but not limited to the examples as follows.

- (1) We shall make no warranty as to completeness, legality, moral correctness, recency, and appropriateness of the Service and the User shall assume full risk and individual responsibility for using the Service.

- (2) We shall assume no responsibility for any loss or damage that may be incurred by the User due to its use of or inability to use the Service, regardless of whether such loss or damage is direct or indirect, foreseeable or unforeseeable, including but not limited to special damages.
- (3) We shall not be involved in nor assume responsibility for any acts, problems, and other issues between Users.
- (4) Should any third parties suffer losses or damages as a result of the User's use of the Service, we shall assume no responsibility therefor.
- (5) Should the User suffer losses or damages from misuse by any third parties of the User's registered user account name or password for the Service, we shall assume no responsibility therefor.

4. Prohibited Matters

Concerning the use of the Service, the following or similar acts by the User are prohibited. Further, should we determine that the User has violated the terms of this Agreement, we reserve the right to suspend use of the Service by the User without prior notice, or take other necessary measures as we may deem necessary. In such case, we bear no obligation to disclose our reasons therefor.

- (1) Acts for commercial purposes or gain
- (2) Use of the account name or password of his own or any third parties for improper purposes
- (3) Infringement or acts that may likely infringe on the intellectual property rights of third parties (including but not limited to copyrights, design rights, patent, utility model rights, trademark, trade secrets, and know-how)
- (4) Infringement or acts that may likely infringe on the proprietary rights, honor, trustworthiness, portrait rights, privacy, publicity rights, and other rights or profits
- (5) Dissemination or distribution or acts that may likely constitute dissemination or distribution of contents that may be offensive to public morals, or defamatory to third parties
- (6) Criminal acts, acts associated with criminal acts, or acts that may likely be criminal
- (7) Dissemination or distribution of junk mail, spam or malicious programs such as the computer viruses
- (8) Dissemination or distribution of false information
- (9) Obstruction or acts that may likely constitute obstruction of the operation of the Service
- (10) Acts that cause or that may likely cause trouble, disadvantages or damages to us or third parties
- (11) Use of the Service for illegal purposes
- (12) Other acts deemed inappropriate by us

5. Compensation Claim

Should any complaints, lawsuits or similar claims be asserted against us by other Users or third parties for any reasons attributable to the User in connection

with the Service, we reserve the right to claim from the concerned User any damages, costs and expenses which we may incur (including compensation, attorney fees and legal costs).

6. Ownership of Intellectual Property Rights

All intellectual property rights (including but not limited to copyrights, design rights, patent, utility model rights, trademark, trade secrets, and know-how), the portrait rights, privacy, publicity rights and other personal rights, and proprietary rights or other property rights of the information, text, image, program, layout, design, architecture, and others related to the Service are owned by us, or provided to us under license from the rights holder except for the rights of the thing which are made by User. The unauthorized copying, alteration, or sublicensing of such intellectual property rights, in whole or in part, without our consent may be prohibited by applicable law.

Further, our trade names, trademarks, logo marks and product names, some of which are registered, are used as names and symbols for commercial purposes. Also, trademarks, service names, symbols and other marks belonging to other parties, such as companies and individuals, are also included in the Service.

7. Use of Public Information

We may save and store all information (including but not limited to text information, image information, and others) that were released, posted, uploaded, or saved by User via the Service. Furthermore, User shall agree that we may use such information as described previously in every possible condition toward smooth operation and improvement of the Service.

8. Usage Fee

The Service shall be offered without charge to the User. However, the environment that is necessary for use this Service shall be prepared by User on his own responsibility and liability including any miscellaneous expenses such as provider, electricity, packet communication, and others.

9. User Information

In order to take advantage of the Service, the User must first register user account name, password, the User's valid e-mail address and arbitrary User's information via the next page (collectively "Information"). We shall properly manage and keep Information as important data in conformity with our "Privacy Policy" and shall only use Information for issuing notices regarding completion of registration, maintenance of Service, suspension of Service, and procedures for reissuance of passwords. We shall not disclose Information for any purposes other than the foregoing without the prior consent of the User.

10. Governing Law

The Agreement shall be governed by and construed in accordance with the laws of Japan.

■ The marking of products using lasers

**CLASS 1
LASER PRODUCT**

The label is attached to the chassis/case and says that the component uses laser beams that have been classified as Class 1. It means that the unit is utilizing laser beams that are of a weaker class. There is no danger of hazardous radiation outside the unit.

■ Information on Disposal of Old Electrical and Electronic Equipment and Batteries (applicable for EU countries that have adopted separate waste collection systems)

Products and batteries with the symbol (crossed-out wheeled bin) cannot be disposed as household waste. Old electrical and electronic equipment and batteries should be recycled at a facility capable of handling these items and their waste byproducts.

Contact your local authority for details in locating a recycle facility nearest to you.

Proper recycling and waste disposal will help conserve resources whilst preventing detrimental effects on our health and the environment.

Notice: The sign "Pb" below the symbol for batteries indicates that this battery contains lead.



■ About W02-5617 (USB Wi-Fi® adapter)

The Wi-Fi Adapter is attached to this unit when shipped from the factory. When the adapter is removed, store it in a safe place.

Declaration of Conformity with regard to the EMC Directive 2004/108/EC
Declaration of Conformity with regard to the R&TTE Directive 1999/5/EC
Manufacturer:

JVC KENWOOD Corporation

3-12, Moriyacho, Kanagawa-ku, Yokohama-shi, Kanagawa 221-0022, JAPAN

EU Representative's:

Kenwood Electronics Europe BV

Amsterdamseweg 37, 1422 AC UITHOORN, The Netherlands

English

Hereby, JVC KENWOOD declares that this unit DNN9230DAB is in compliance with the essential requirements and other relevant provisions of Directive 1999/5/EC.

Français

Par la présente JVC KENWOOD déclare que l'appareil DNN9230DAB est conforme aux exigences essentielles et aux autres dispositions pertinentes de la directive 1999/5/CE.

Par la présente, JVC KENWOOD déclare que ce DNN9230DAB est conforme aux exigences essentielles et aux autres dispositions de la directive 1999/5/CE qui lui sont applicables.

Deutsch

Hiermit erklärt JVC KENWOOD, dass sich dieser DNN9230DAB in Übereinstimmung mit den grundlegenden Anforderungen und den anderen relevanten Vorschriften der Richtlinie 1999/5/EG befindet. (BMWV)

Hiermit erklärt JVC KENWOOD die Übereinstimmung des Gerätes DNN9230DAB mit den grundlegenden Anforderungen und den anderen relevanten Festlegungen der Richtlinie 1999/5/EG. (Wien)

Nederlands

Hierbij verklaart JVC KENWOOD dat het toestel DNN9230DAB in overeenstemming is met de essentiële eisen en de andere relevante bepalingen van richtlijn 1999/5/EG.

Bij deze verklaart JVC KENWOOD dat deze DNN9230DAB voldoet aan de essentiële eisen en aan de overige relevante bepalingen van Richtlijn 1999/5/EC.

Italiano

Con la presente JVC KENWOOD dichiara che questo DNN9230DAB è conforme ai requisiti essenziali ed alle altre disposizioni pertinenti stabilite dalla direttiva 1999/5/CE.

Español

Por medio de la presente JVC KENWOOD declara que el DNN9230DAB cumple con los requisitos esenciales y cualesquiera otras disposiciones aplicables o exigibles de la Directiva 1999/5/CE.

Português

JVC KENWOOD declara que este DNN9230DAB está conforme com os requisitos essenciais e outras disposições da Directiva 1999/5/CE.

Polska

JVC KENWOOD niniejszym oświadcza, że DNN9230DAB spełnia zasadnicze wymagania oraz inne istotne postanowienia dyrektywy 1999/5/EC.

Český

JVC KENWOOD tímto prohlašuje, že DNN9230DAB je ve shodě se základními požadavky a s dalšími příslušnými ustanoveními Nařízení vlády č. 426/2000 Sb.

Magyar

Alulírott, JVC KENWOOD, kijelenti, hogy a jelen DNN9230DAB megfelel az 1999/5/EC irányelvben meghatározott alapvető követelményeknek és egyéb vonatkozó előírásoknak.

Svenska

Härmed intygar JVC KENWOOD att denna DNN9230DAB står i överensstämmelse med de väsentliga egenskapskrav och övriga relevanta bestämmelser som framgår av direktiv 1999/5/EG.

Suomi

JVC KENWOOD vakuuttaa täten että DNN9230DAB tyyppinen laite on direktiivin 1999/5/EY oleellisten vaatimusten ja sitä koskevien direktiivin muiden ehtojen mukainen.

Slovensko

S tem JVC KENWOOD izjavlja, da je ta DNN9230DAB v skladu z osnovnimi zahtevami in ostalimi ustreznimi predpisi Direktive 1999/5/EC.

Slovensky

Spoločnosť JVC KENWOOD týmto vyhlasuje, že DNN9230DAB spĺňa základné požiadavky a ďalšie príslušné ustanovenia Direktívy 1999/5/EC.

Dansk

Undertegnede JVC KENWOOD erklærer herved, at følgende udstyr DNN9230DAB overholder de væsentlige krav og øvrige relevante krav i direktiv 1999/5/EF.

Ελληνικά

ΜΕ ΤΗΝ ΠΑΡΟΥΣΑ JVC KENWOOD ΔΗΛΩΝΕΙ ΟΤΙ ΔΝΝ9230DAB ΣΥΜΜΟΡΦΩΝΕΤΑΙ ΠΡΟΣ ΤΙΣ ΟΥΣΙΩΔΕΙΣ ΑΠΑΙΤΗΣΕΙΣ ΚΑΙ ΤΙΣ ΛΟΙΠΕΣ ΣΧΕΤΙΚΕΣ ΔΙΑΤΑΞΕΙΣ ΤΗΣ ΟΔΗΓΙΑΣ 1999/5/ΕΚ.

Eesti

Sellega kinnitab JVC KENWOOD, et see DNN9230DAB vastab direktiivi 1999/5/EC põhilistele nõudmistele ja muudele asjakohastele määrustele.

Latviešu

Ar šo, JVC KENWOOD, apstiprina, ka DNN9230DAB atbilst Direktīvas 1999/5/EK galvenajām prasībām un citiem tās nosacījumiem.

Lietuviški

Šiuo, JVC KENWOOD, pareiškia, kad šis DNN9230DAB atitinka pagrindinius Direktyvos 1999/5/EB reikalavimus ir kitas svarbias nuostatas.

Malti

Hawnhekk, JVC KENWOOD, jiddikjara li dan DNN9230DAB jikkonforma mal-ftiġġiet essenzjali u ma provvedimenti oħrajn relevanti li hemm fid-Direttiva 1999/5/EC.

Українська

Компанія JVC KENWOOD заявляє, що цей виріб DNN9230DAB відповідає ключовим вимогам та іншим пов'язаним положенням Директиви 1999/5/EC.

Norsk

JVC KENWOOD erklærer herved at enheten DNN9230DAB oppfyller grunnleggende krav og andre bestemmelser i direktiv 1999/5/EF.

Türkçe

Bu vesileyle JVC KENWOOD, DNN9230DAB ünitesinin, 1999/5/EC Direktifinin başlıca gereksinimleri ve diğer ilgili hükümleri ile uyumlu olduğunu beyan eder.

DAB+
Digital Audio Broadcasting



DOLBY
DIGITAL

dts
2.0 Channel

DivX

Bluetooth

WiFi
CERTIFIED

Made for
iPod iPhone

Designed for
Windows
Media



KENWOOD

W02-5617 (USB Wi-Fi® adapter)

Instruction Manual

⚠ CAUTION

Changes or modifications not approved by us could void the user's authority to operate the equipment.

- This adapter has been designed exclusively for use with Kenwood car receivers. Do not use this adapter with any other car receiver.
- The Wi-Fi CERTIFIED Logo is a certification mark of the Wi-Fi Alliance.



Specifications

IEEE Standard:

802.11b/g/n

Security Support:

64/128 bit WEP /WPA & WPA2

Frequency Range:

2.401 GHz – 2.483 GHz

Transfer rates (MAX.):

802.11n (150 Mbps)

802.11g (54 Mbps)

802.11b (11 Mbps)

Output Power:

16 – 18dBm (CCK)

13 – 15dBm (OFDM)

Power Consumption:

5 V/100 mA (MAX.)

Dimensions (L × W × H):

15 mm × 19 mm × 5.6 mm

Design and specifications are subject to change without notice.

Keep the Wi-Fi adapter inserted when using the Wi-Fi function.

When the adapter is removed, store it in a safe place.



Declaration of Conformity with regard to the R&TTE Directive 1999/5/EC Manufacturer:

JVC KENWOOD Corporation

3-12 Moriya-cho, Kanagawa-ku, Yokohama-shi, Kanagawa, 221-0022, Japan

EU Representative's:

Kenwood Electronics Europe BV

Amsterdamseweg 37, 1422 AC UITHOORN, The Netherlands

English

Hereby, JVC KENWOOD declares that this unit W02-5617 is in compliance with the essential requirements and other relevant provisions of Directive 1999/5/EC.

Français

Par la présente JVC KENWOOD déclare que l'appareil W02-5617 est conforme aux exigences essentielles et aux autres dispositions pertinentes de la directive 1999/5/CE.

Par la présente, JVC KENWOOD déclare que ce W02-5617 est conforme aux exigences essentielles et aux autres dispositions de la directive 1999/5/CE qui lui sont applicables.

Deutsch

Hiermit erklärt JVC KENWOOD, dass sich dieser W02-5617 in Übereinstimmung mit den grundlegenden Anforderungen und den anderen relevanten Vorschriften der Richtlinie 1999/5/EG befindet. (BMWi)

Hiermit erklärt JVC KENWOOD die Übereinstimmung des Gerätes W02-5617 mit den grundlegenden Anforderungen und den anderen relevanten Festlegungen der Richtlinie 1999/5/EG. (Wien)

Nederlands

Hierbij verklaart JVC KENWOOD dat het toestel W02-5617 in overeenstemming is met de essentiële eisen en de andere relevante bepalingen van richtlijn 1999/5/EG.

Bij deze verklaart JVC KENWOOD dat deze W02-5617 voldoet aan de essentiële eisen en aan de overige relevante bepalingen van Richtlijn 1999/5/EC.

Italiano

Con la presente JVC KENWOOD dichiara che questo W02-5617 è conforme ai requisiti essenziali ed alle altre disposizioni pertinenti stabilite dalla direttiva 1999/5/CE.

Español

Por medio de la presente JVC KENWOOD declara que el W02-5617 cumple con los requisitos esenciales y cualesquiera otras disposiciones aplicables o exigibles de la Directiva 1999/5/CE.

Português

JVC KENWOOD declara que este W02-5617 está conforme com os requisitos essenciais e outras disposições da Directiva 1999/5/CE.

Polska

JVC KENWOOD niniejszym oświadcza, że W02-5617 spełnia zasadnicze wymagania oraz inne istotne postanowienia dyrektywy 1999/5/EC.

Český

JVC KENWOOD tímto prohlašuje, že tento W02-5617 je ve shodě se základními požadavky a dalšími příslušnými ustanoveními směrnice 1999/5/ES.

Magyar

Alulírott, JVC KENWOOD, kijelenti, hogy a jelen W02-5617 megfelel az 1999/5/EC irányelvben meghatározott alapvető követelményeknek és egyéb vonatkozó előírásoknak.

Svenska

Härmed intygar JVC KENWOOD att denna W02-5617 står i överensstämmelse med de väsentliga egenskapskrav och övriga relevanta bestämmelser som framgår av direktiv 1999/5/EG.

Suomi

JVC KENWOOD vakuuttaa täten että W02-5617 tyyppinen laite on direktiivin 1999/5/EY oleellisten vaatimusten ja sitä koskevien direktiivin muiden ehtojen mukainen.

Slovensko

S tem JVC KENWOOD izjavlja, da je ta W02-5617 v skladu z osnovnimi zahtevami in ostalimi ustreznimi predpisi Direktive 1999/5/EC.

Slovensky

Spoločnosť JVC KENWOOD týmto vyhlasuje, že W02-5617 spĺňa základné požiadavky a ďalšie príslušné ustanovenia Direktívy 1999/5/EC.

Dansk

Undertegnede JVC KENWOOD erklærer herved, at følgende udstyr W02-5617 overholder de væsentlige krav og øvrige relevante krav i direktiv 1999/5/EF.

Ελληνικά

ΜΕ ΤΗΝ ΠΑΡΟΥΣΑ JVC KENWOOD ΔΗΛΩΝΕΙ ΟΤΙ W02-5617 ΣΥΜΜΟΡΦΩΝΕΤΑΙ ΠΡΟΣ ΤΙΣ ΟΥΣΙΩΔΕΙΣ ΑΠΑΙΤΗΣΕΙΣ ΚΑΙ ΤΙΣ ΛΟΙΠΕΣ ΣΧΕΤΙΚΕΣ ΔΙΑΤΑΞΕΙΣ ΤΗΣ ΟΔΗΓΙΑΣ 1999/5/ΕΚ.

Eesti

Sellega kinnitab JVC KENWOOD, et see W02-5617 vastab direktiivi 1999/5/EC põhilistele nõudmistele ja muudele asjakohastele määrustele.

Latviešu

Ar šo, JVC KENWOOD, apstiprina, ka W02-5617 atbilst Direktīvas 1999/5/EK galvenajām prasībām un citiem tās nosacījumiem.

Lietuviškai

Šiuo, JVC KENWOOD, pareiškia, kad šis W02-5617 atitinka pagrindinius Direktyvos 1999/5/EB reikalavimus ir kitas svarbias nuostatas.

Malti

Hawnhekk, JVC KENWOOD, jiddikjara li dan W02-5617 jikkonforma mal-htigijiet essenzjali u ma provvedimenti oħrajn relevanti li hemm fid-Direttiva 1999/5/EC.

Українська

Компанія JVC KENWOOD заявляє, що цей виріб W02-5617 відповідає ключовим вимогам та іншим пов'язаним положенням Директиви 1999/5/EC.

Norsk

JVC KENWOOD erklærer herved at enheten W02-5617 oppfyller grunnleggende krav og andre bestemmelser i direktiv 1999/5/EF.

Türkçe

Bu vesileyle JVC KENWOOD, W02-5617 ünitesinin, 1999/5/EC Direktifinin başlıca gereksinimleri ve diğer ilgili hükümleri ile uyumlu olduğunu beyan eder.