



CONNECTED NAVIGATION SYSTEM

DNN9250DAB

DNN6250DAB

CONNECTED MONITOR WITH DVD RECEIVER

DNR8025BT

INSTRUCTION MANUAL

JVCKENWOOD Corporation

Before reading this manual, click the button below to check the latest edition and the modified pages.

<http://manual.kenwood.com/edition/im383/>



What Do You Want To Do?

Thank you for purchasing the KENWOOD CONNECTED NAVIGATION SYSTEM.
In this manual, you will learn various convenient functions of the system.

Click the icon of the media you want to play.

With one-click, you can jump to the section of each media!

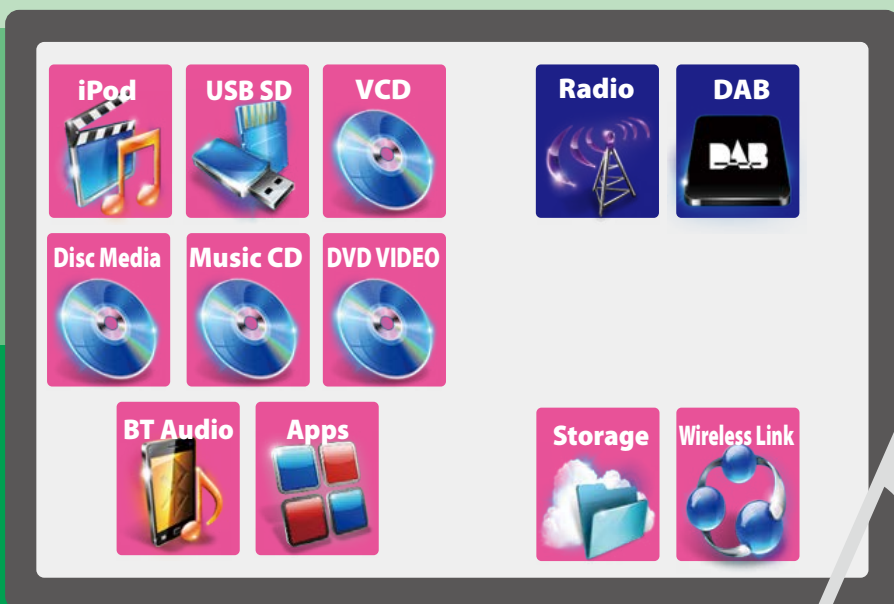

Contents

Before Use	4	Widget and Application	
▲ WARNING _____	4	Operation	44
How to Read this Manual	7	Weather Widget _____	44
Features of Connected systems	8	Weather Application _____	45
Basic Operations	10	Today Widget _____	47
Functions of the Buttons		SNS Widget _____	47
on the Front Panel _____	10	RSS Widget _____	48
Turning on the Unit _____	14	Schedule Application _____	48
Detaching The Front Panel _____	19	Facebook (SNS Application) _____	51
How to Play Media _____	20	Twitter (SNS Application) _____	52
Operation on the Home Screen _____	23	E-mail (SNS Application) _____	54
Common Operation _____	27	RSS Application _____	56
Navigation Operation		Now playing Widget _____	58
(DNN9250DAB/ DNN6250DAB) _____	29	Summary Board Widget _____	60
Network Setup	34	Photo Frame Widget _____	61
Wi-Fi Setup _____	34	Mixed Media Search _____	62
Wi-Fi Hotspot Setup _____	36	DVD/Video CD (VCD)	
Clock and Date Setup	38	Operation	64
Clock and Date Setup _____	38	DVD/VCD Basic Operation _____	64
Account Setup	40	DVD Disc Menu Operation _____	67
About Account _____	40	Zoom Control for DVD and VCD _____	68
Create User Account _____	40	DVD Setup _____	69
Set Owner Account _____	41	CD/Audio and Visual Files/iPod/	
Set User Account _____	42	Apps Operation	72
Switch the User Login _____	42	Music/Video Basic Operation _____	72
Delete User Account _____	43	Search Operation _____	78
Reset Owner Account _____	43	Movie Control _____	82
		Apps Operation _____	83
		USB/SD/iPod/DivX/Apps Setup _____	84
		Cloud Storage Operation	90
		Starting procedure _____	90
		Music Basic Operation _____	90
		Category search _____	91

Kenwood Wireless Link Operation 92

Starting procedure _____	92
Media Server function _____	93
Media Player function _____	93
Media Controller function _____	94
Media Renderer function _____	95

Radio and TV Tuner Operation 96

Radio Basic Operation _____	96
Digital Radio Basic Operation (DNN9250DAB/ DNN6250DAB) _____	98
Memory Operation _____	100
Selecting Operation _____	100
Traffic Information _____	102
Replay (Digital Radio only) _____	102
Tuner Setup _____	103
DAB Setup (DNN9250DAB/ DNN6250DAB) _____	104
TV Tuner Operation _____	106

Streaming Service Application 108

Streaming Video Application _____	108
AUPEO! Application _____	110

Bluetooth Control 112

Registering and Connecting Bluetooth Unit _____	112
Playing Bluetooth Audio Device _____	115
Using Hands-Free Feature _____	116
Hands-Free Setup _____	120

Voice Control (DNN9250DAB) 122

Voice Control _____	122
---------------------	-----

Camera Control (DNN9250DAB/ DNR8025BT) 123

Camera Control _____	123
Switching the View Camera _____	123

Setting Up 124

Monitor Screen Setup _____	124
System Setup _____	125
Display Setup _____	128
Navigation Setup (DNN9250DAB/ DNN6250DAB) _____	130
Camera Setup _____	131
Software Information _____	132
AV Input Setup _____	133
AV Output Interface Setup _____	133

Controlling Audio 134

Setting Audio _____	134
Controlling General Audio _____	137
Equalizer Control _____	138
Zone Control _____	139
Sound Effect _____	140
Listening Position _____	142

Remote Control 144

Battery Installation _____	144
Functions of the Remote Control Buttons _____	145

Troubleshooting 148

Problems and Solutions _____	148
Error Messages _____	149
Resetting the Unit _____	151

Appendix 152

Playable Media and Files _____	152
Status Bar Indicator Items _____	155
Region Codes in the World _____	157
DVD Language Codes _____	158
Specifications _____	159
Trademarks _____	162
Safety precaution _____	166

Before Use

WARNING

To prevent injury or fire, take the following precautions:

- To prevent a short circuit, never put or leave any metallic objects (such as coins or metal tools) inside the unit.
- Do not watch or fix your eyes on the unit's display when you are driving for any extended period.
- If you experience problems during installation, consult your Kenwood dealer.

Precautions on using this unit

- When you purchase optional accessories, check with your Kenwood dealer to make sure that they work with your model and in your area.
- You can select language to display menus, audio file tags, etc. See [Language setup \(P.126\)](#).
- The Radio Data System or Radio Broadcast Data System feature won't work where the service is not supported by any broadcasting station.

Protecting the monitor

To protect the monitor from damage, do not operate the monitor using a ball point pen or similar tool with the sharp tip.

Cleaning the unit

If the faceplate of this unit is stained, wipe it with a dry soft cloth such as a silicon cloth. If the faceplate is stained badly, wipe the stain off with a cloth moistened with neutral cleaner, then wipe it again with a clean soft dry cloth.



- Applying spray cleaner directly to the unit may affect its mechanical parts. Wiping the faceplate with a hard cloth or using a volatile liquid such as thinner or alcohol may scratch the surface or erase screened print.

Lens fogging

When you turn on the car heater in cold weather, dew or condensation may form on the lens in the disc player of the unit. Called lens fogging, this condensation on the lens may not allow discs to play. In such a situation, remove the disc and wait for the condensation to evaporate. If the unit still does not operate normally after a while, consult your Kenwood dealer.

Precautions on handling discs

- Do not touch the recording surface of the disc.
- Do not stick tape etc. on the disc, or use a disc with tape stuck on it.
- Do not use disc type accessories.
- Clean from the center of the disc and move outward.
- When removing discs from this unit, pull them out horizontally.
- If the disc center hole or outside rim has burrs, use the disc only after removing the burrs with a ballpoint pen etc.
- Discs that are not round cannot be used.

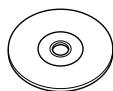

- 8-cm (3 inch) discs cannot be used.
- Discs with coloring on the recording surface or discs that are dirty cannot be used.
- This unit can only play the CDs with . This unit may not correctly play discs which do not have the mark.
- You cannot play a disc that has not been finalized. (For the finalization process see your writing software, and your recorder instruction manual.)

Erase the personal information

Before giving or selling this unit to others, be sure to delete the information (mail, search logs, etc.) stored in this unit by yourself and confirm that the data has been deleted.

We shall not be liable for any damage caused by leakage of undeleted data.

1 Press the <HOME> button.

DNN9250DAB/ DNR8025BT



DNN6250DAB

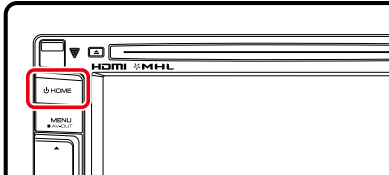

2 Press the <MENU> button.

DNN9250DAB/ DNR8025BT



DNN6250DAB

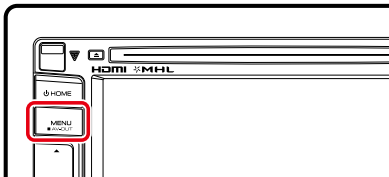

3 Touch [Setting].

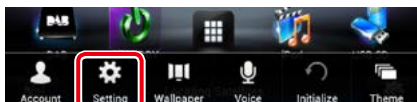

4 Touch [Backup & Reset].

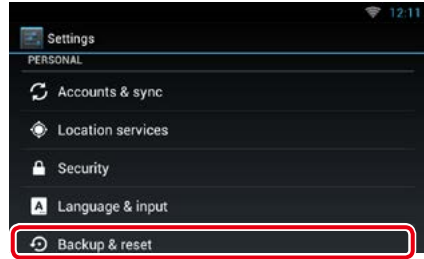

5 Touch [Factory data reset].

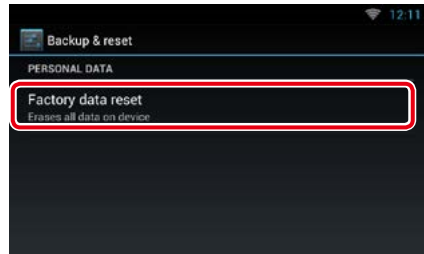

6 Enter owner password. Touch [Rest].



7 Touch [ERASE].

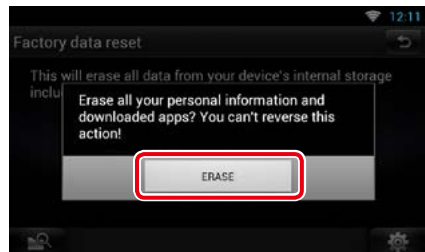

How to Read this Manual

[Return to the Top page](#)

[CD/Audio and Visual Files/iPod/Apps Operation](#)

Search Operation

You can search music, video or picture files by the following operations.

NOTE

- If you use a remote controller, you can jump directly to the desired track/file with entering the track/folder/file number, play time, etc. For details, see [Direct search mode \(P.145\)](#).

List search

You can search tracks, folders, and files according to hierarchy.

1 Touch illustrated area.

List Control screen appears.

2 Touch desired track/file.



Playback starts.

Other search

When you want to narrow the list down, there are other search ways.

This function is not available when music CD is the current source.

1 Touch [] in the control screen.

The search type screen appears.

2 Touch desired search way.

Link header

You can refer each section or top page with one-click.

Operation title

Introduces the function.

NOTE

Introduces some tips, notes, etc.

Reference mark

Displayed in blue notes.

With one-click, you can jump to the article related to the current section.

Operation procedure

Explains necessary procedures to achieve the operation.

< >: Indicates the name of panel buttons.

[]: Indicates the name of touch keys.

Screen shot

Shows some screen shots displayed during operation for reference.

The area or keys to touch are surrounded with a red frame.

NOTE

- The screens and panels shown in this manual are examples used to provide clear explanations of the operations. For this reason, they may be different from the actual screens or panels used, or some display patterns may be different.

Features of Connected systems

By connecting this unit to Internet, you can use various services.

Cooperation with Route Collector site

- Destinations and routes specified on the PC can be input to this navigation system.
- The routes you have traveled and the songs you have listened to can be logged. [\(P.31\)](#)
- By uploading music files to Dropbox and creating a play list on Route Collector site, you can listen to music anywhere through streaming without music files on this unit. [\(P.90\)](#)
- Speech to Text (STT) and Text to Speech (TTS).

Use of internet service

- Streaming service such as YouTube, Aupeol.
- Internet service such as email, Gmail, Google calendar, and social networking service such as Facebook and Twitter.
- Information (weather*, traffic*, RSS, etc.) service.

About the account

- To use internet services via this system, you need to create an account in the Route Collector site.
- In addition to the owner account, you can register up to four user accounts.
- You can use a guest account as well.
- By switching among accounts, you can secure the privacy when using the mail feature or social media.

For details, see [About Account \(P.40\)](#).
<http://www.route-collector.com/>

Notes

You can use following feature for 2 years after registration of the owner account. To use it continuously, a usage fee is required. For details, see web site of Route Collector.

<http://www.route-collector.com/>

- Weather (by INRIX)*
- Traffic (by INRIX)*
- Dynamic Parking (by INRIX)*
- Fuel Prices (by INRIX)*
- Real-Time Traffic Camera (by INRIX)*
- Movie Show Times (by WWM)*
- TTS (by Nuance)
- STT (by Nuance)

To use the following services, you need to register the corresponding free or paid accounts.

- Aupeol
- Facebook
- Twitter
- Gmail (by Google)
- Google calendar (by Google)
- Dropbox

* DNN9250DAB/ DNN6250DAB only

Wi-Fi access point

- Connect to Internet using the tethering function of your smartphone or an Internet device. [\(P.34\)](#)

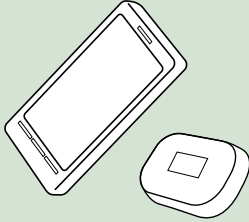

**4G, 3G, LTE
or EDGE**



Wi-Fi hotspot

- This unit becomes the Wi-Fi access point and you can enjoy music and video in a smartphone Wi-Fi connected by Kenwood Wireless Link. [\(P.36\)](#)

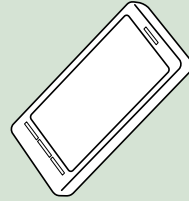

Wi-Fi (11n/g/b)

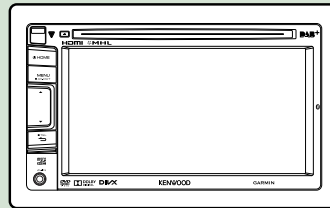
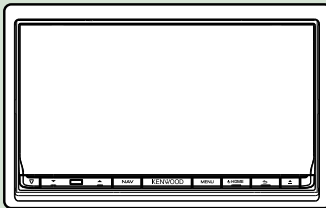

- Media player for DVD video, CD, USB memory, SD card*, iPod, etc.
- Digital Radio (DAB)* and Analog Radio.
- Navigation*

Basic Operations

Functions of the Buttons on the Front Panel

DNN9250DAB/ DNR8025BT

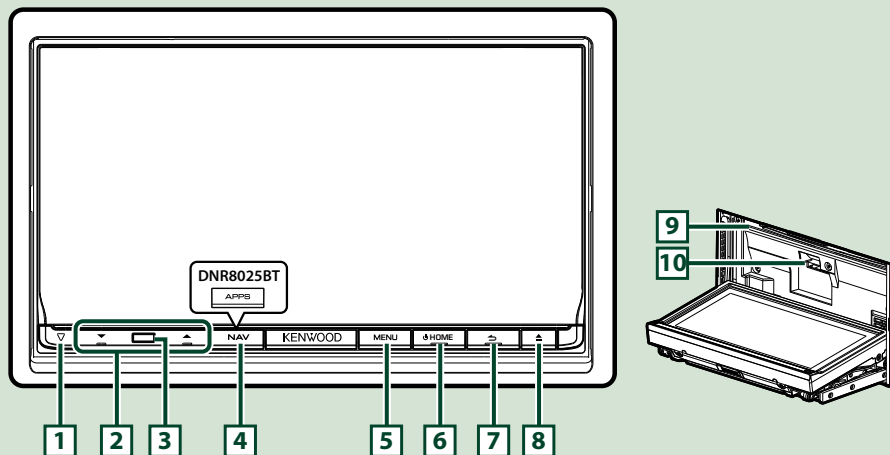

NOTE

- The panels shown in this guide are examples used to provide clear explanations of the operations. For this reason, they may be different from the actual panels.

How to insert an SD Card (DNN9250DAB)

- 1) Press **[8] <▲>** button for 1 second.
The panel fully opens.
- 2) Hold the SD card as the illustration in the right and insert it into the slot until it clicks.

● To eject the card:

Push the card until it clicks and then remove your finger from the card.

The card pops up so that you can pull it out with your fingers.

Labelled side

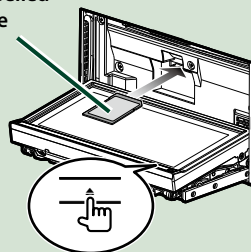

Number	Name	Motion
1	▽ (Reset)	<ul style="list-style-type: none"> If the unit or the connected unit fails to operate properly, the unit returns to initial settings when this button is pressed (P.151). If the SI function is turned on, this indicator flashes when the vehicle ignition is off (P.126).
2	▼, ▲ (Vol)	Adjusts volume.
3	Remote Sensor	Receives the remote control signal.
4	NAV (DNN9250DAB)	<ul style="list-style-type: none"> Displays the navigation screen. Pressing for 1 second turns the screen off.*
	APPS (DNR8025BT)	<ul style="list-style-type: none"> Displays the APPS screen . Pressing for 1 second turns the screen off.*
5	MENU	<ul style="list-style-type: none"> Displays the option menu screen. Pressing for 1 second switches AV out sources.
6	HOME	<ul style="list-style-type: none"> Displays the Home screen (P.23). Pressing for 1 second turns the power off. When the power off, turns the power on.
7	↶ (Back)	<ul style="list-style-type: none"> Return to the previously viewed screen. Pressing for 1 second displays the Hands Free screen (P.116).
8	▲ (Eject)	<ul style="list-style-type: none"> Ejects the disc. When the panel is opened, pressing closes the panel and pressing for 1 second ejects the disc forcibly. When the panel is closed, pressing for 1 second fully opens the panel to the location of the SD card slot. (DNN9250DAB)
9	Disc insert slot	A slot to insert a disc media.
10	SD card slot (DNN9250DAB)	A slot to insert an SD card.

* The function of the [NAV]/ [APPS] button can be changed to camera view function. See [User interface \(P.125\)](#).

DNN6250DAB

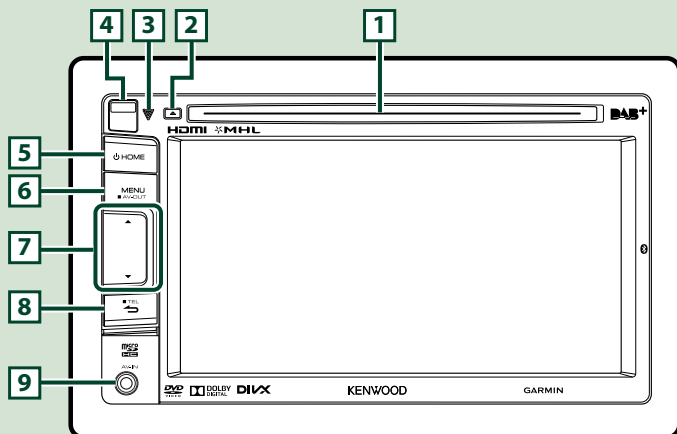

NOTE

- The panels shown in this guide are examples used to provide clear explanations of the operations. For this reason, they may be different from the actual panels.
- If above icons are showed, read the article applicable to the unit you use.

How to insert a microSD Card

- 1) Slide the **4** Release key upward to detach the part of the front panel.
- 2) Hold the microSD card with the label side facing left and the notched section up, and insert it into the slot until it clicks.

● To eject the card:

Push the card until it clicks and then remove your finger from the card.

The card pops up so that you can pull it out with your fingers.

NOTE

- When detaching a part of the front panel, detach it toward the front side as shown in the diagram right. If it is detached upward, the front panel will be broken.

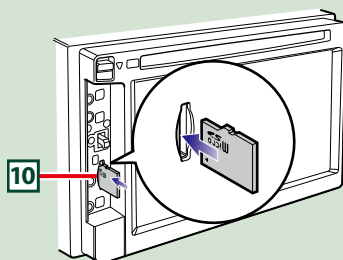
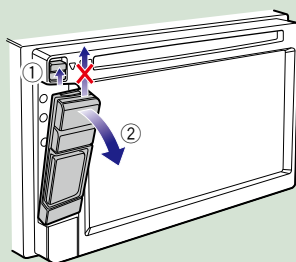

Number	Name	Motion
1	Disc insert slot	A slot to insert a disc media.
2	▲ (Eject)	<ul style="list-style-type: none"> Ejects the disc. Pressing for 1 second ejects the disc forcibly.
3	▽ (Reset)	<ul style="list-style-type: none"> If the unit or the connected unit fails to operate properly, the unit returns to initial settings when this button is pressed (P.151). If the SI function is turned on, this indicator flashes when the vehicle ignition is off (P.126).
4	Release key	Detaches the part of front panel.
5	HOME	<ul style="list-style-type: none"> Displays the Home screen (P.23). Pressing for 1 second turns the power off. When the power off, turns the power on.
6	MENU	<ul style="list-style-type: none"> Displays the option menu screen. Pressing for 1 second switches AV out sources.
7	▼, ▲ (Vol)	Adjusts volume.
8	↶ (Back)	<ul style="list-style-type: none"> Return to the previously viewed screen. Pressing for 1 second displays the Hands Free screen (P.116).
9	Input jack	An input jack for external device. (CA-C3AV; Optional Accessory)
10	microSD card slot	A slot to insert an microSD card.

Turning on the Unit

The method for turning on the power varies between different models.

DNN9250DAB/ DNR8025BT

- 1 Press the <HOME> button.

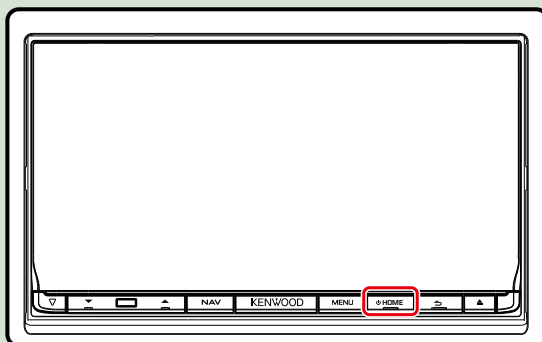

The unit is turned on.

- **To turn off the navigation system:**

Press the <HOME> button for 1 second.

DNN6250DAB

- 1 Press the <HOME> button.

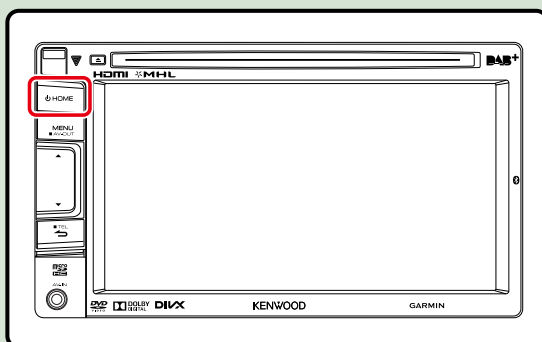

The unit is turned on.

- **To turn off the unit:**

Press the <HOME> button for 1 second.

If it is your first time turning the unit on after installation, it will be necessary to perform [Initial setup \(P.16\)](#).

Login

1 Select the login user.

When the owner has not been registered



When the owner has been registered

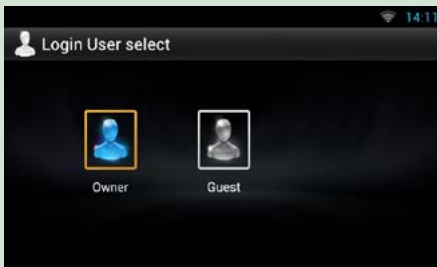

2 Enter the password.

When you selected Administrator or Guest, you do not need to enter a password.



[Auto Login?]: Checking this checkbox allows you to log in to the system automatically from the next time.

3 Touch [Login].

NOTE

- If you forgot your password, create your new password on the Route Collector site.
<http://www.route-collector.com/>

Initial setup

Perform this setup when you use this unit for the first time or when you reset the unit. See [Resetting the Unit \(P.151\)](#).

1 Set each item as follows.



Language Setup

Set the language used for the GUI and input methods. Default is "English (United States)".

- ① Touch [Language Setup].
- ② Select a language from the list.

WiFi Setup

Configure settings for connection to Wi-Fi.

- ① Touch [WiFi Setup].
- ② Slide Wi-Fi to ON.
- ③ Select the Wi-Fi access point to register from the list.
- ④ Enter the Password.
- ⑤ Touch [Connect].
- ⑥ After setting, press the < ⏪ > button.

For details on operation, see [Wi-Fi Setup \(P.34\)](#).

Date Setup

Set the date and time.

- ① Touch [Date Setup].
- ② Touch [Select time zone].
- ③ Select a time zone.
- ④ After setting, press the < ⏪ > button.

For details on operation, see [Clock and Date Setup \(P.38\)](#).

Account Setup

Set the information about the user of this unit.

- ① Touch [Account Setup].

For details on operation, see [About Account \(P.40\)](#).

2 Touch [Next].

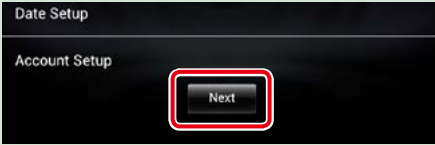

3 Set each item as follows.



Locale

Select the country for the navigation system.

The language, the distance unit, and the gasoline unit are set.

- ① Touch [SET].
- ② Select the desired country.
- ③ Touch [Enter].

Language

Select the language used for the control screen and setting items. Default is "American English (en)".

- ① Touch [SET].
- ② Touch [◀] or [▶] to select the desired language.
- ③ Touch [Enter].

For details on operation, see [Language setup \(P.126\)](#).

Angle (DNN9250DAB/DNR8025BT only)

Adjust the position of the monitor. Default is "0".

- ① Touch [SET].
- ② Touch desired angle number and [↩].

For details on operation, see [Monitor angle control \(P.128\)](#).

Continued

Color

Set the screen and button illumination color. You can select whether to allow color scan operation or select a fixed color for operation.

- ① Touch [SET].
- ② Touch [ON] or [OFF] of [Panel Color Scan].
- ③ If you want to change color, touch [SET] of [Panel Color Coordinate].
- ④ Touch your desired color and [↩].

For details on operation, see [Panel color coordinate \(P.129\)](#).

Camera

Set the parameters for the camera.

- ① Touch [SET].
- ② Set each item and touch [↩].

For details on operation, see [Camera Setup \(P.131\)](#).

DEMO

Set the demonstration mode. Default is "ON".

- ① Touch [ON] or [OFF].

4 Touch [Finish].



NOTE

- These settings can be set from the SETUP menu. See [Setting Up \(P.124\)](#).

Detaching The Front Panel

You can detach the front panel to prevent theft.

DNN9250DAB/ DNR8025BT

- 1 Press the <▲> button for 1 second to open the front panel.

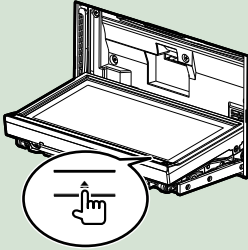

NOTE

- You can set the front panel to open automatically when the ignition is turned off. See [Monitor angle control \(P.128\)](#).

- 2 Detach the panel as the diagrams below.

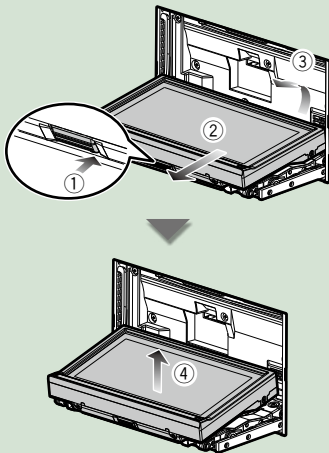

NOTE

- The attaching plate closes automatically in about 10 seconds after the front panel is released. Remove the panel before this happens.

- After detaching:
Put the panel in the protective bag supplied with the unit.

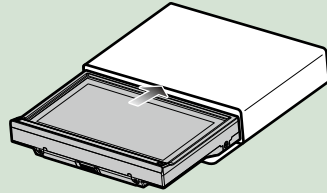

NOTE

- When detaching a part of the front panel, detach it toward the front side as shown in the diagram above. If it is detached upward, the front panel will be broken.
- To prevent deterioration, do not touch the terminals of the unit and faceplate with your fingers.
- If the terminals on the unit or faceplate get dirty, wipe them with a clean soft dry cloth.

DNN6250DAB

- 1 Slide the Release key upward to detach the part of the front panel. Then, detach the panel as the diagrams below.

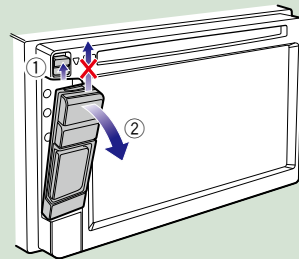

Continued

Attaching the front panel

- 1 Hold the panel securely so as not to drop it accidentally, and fit it onto the attaching plate until it is firmly locked.

DNN9250DAB/ DNR8025BT

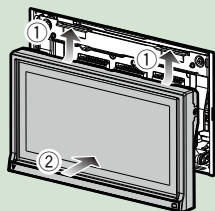

DNN6250DAB

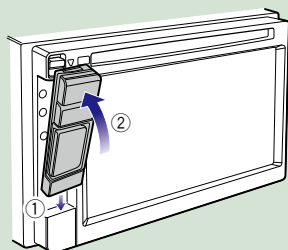

How to Play Media

Music CD and disc media

DNN9250DAB/ DNR8025BT

- 1 Press the <▲> button.

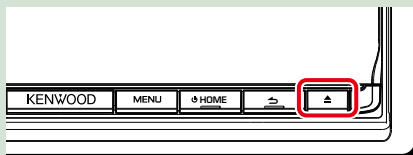

The panel opens.

- 2 Insert the disc into the slot.

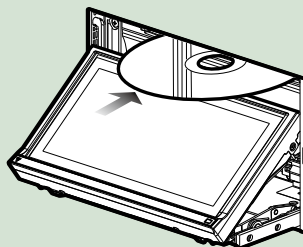

The panel closes automatically.

The unit loads the disc and playback starts.

- **To eject the disc:**
Press the <▲> button.

DNN6250DAB

- 1 Insert the disc into the slot.

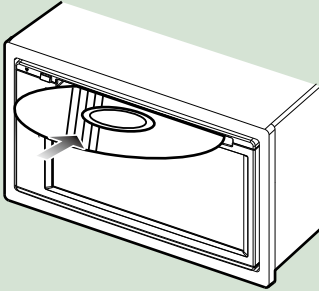

The unit loads the disc and playback starts.

- **To eject the disc:**
Press the <▲> button.

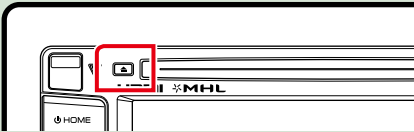

External device (DNN6250DAB)

- 1 Insert the plug into the AV-IN jack.

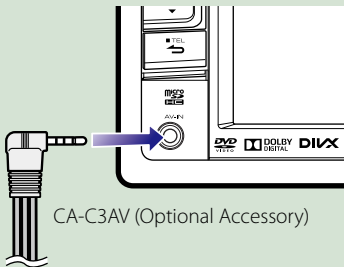

USB device

- 1 Connect the USB device with the USB cable.

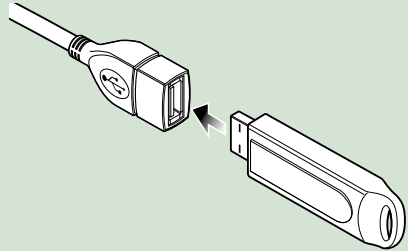

The unit reads the device and playback starts.

- **To disconnect the device:**
Touch [▲] on the screen and disconnect the device from the cable.

iPod

- 1 Connect the iPod.

NOTE

- For the details of the necessary cable and adapter to connect with iPod/iPhone, refer to [Music/Video Basic Operation \(P.72\)](#).

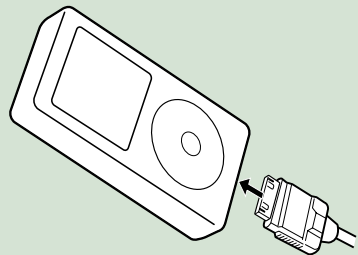

The unit reads the iPod and playback starts.

- **To disconnect the iPod/iPhone connected with the cable:**
Touch [▲] on the screen and disconnect the device from the cable.

SD card

DNN9250DAB

- 1 Press the <▲> button for 1 second to open the front panel.

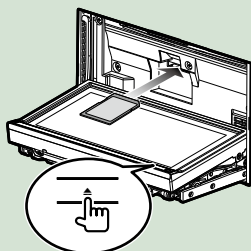

The panel fully opens.

- 2 Hold the SD card as the diagram below and insert it into the slot until it clicks.



The unit loads the card and playback starts.

● **To remove:**

Push the SD card until it clicks and then remove your finger from the card.
The card pops up so that you can pull it out with your fingers.

DNN6250DAB

- 1 Detach the front panel.

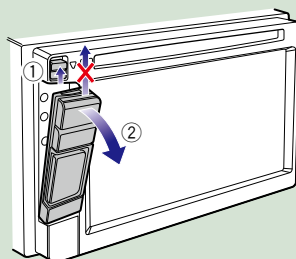

- 2 Hold the microSD card with the label facing up and the notched section right, and insert it into the slot until it clicks.

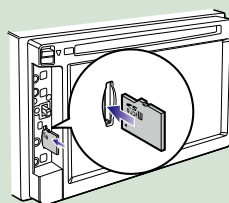

The unit loads the card and playback starts.

● **To remove:**

Push the microSD card until it clicks and then remove your finger from the card.
The card pops up so that you can pull it out with your fingers.

Operation on the Home Screen

Most functions can be operated on the Home screen.

1 Press the <HOME> button.

DNN9250DAB/ DNR8025BT

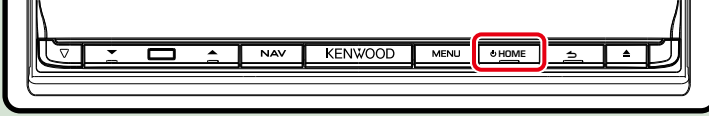

DNN6250DAB

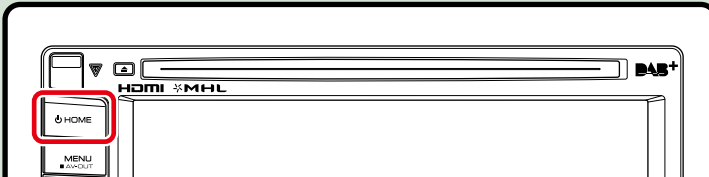

Home screen appears.

2 Flick the screen left or right to select the Service panel, Media panel, Source launcher panel, or Network contents panel.

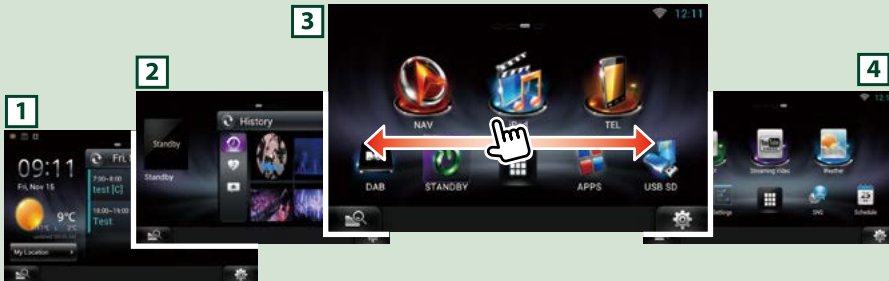

Panel	Description
1 Service panel	Weather widget: Displays the weather forecast for the selected region. Network widget: Displays the schedule, SNS, or RSS.
2 Media panel	Now playing: Displays the title of the song being played or the name of the station you are listening to, and allows you to perform simple operations. Media widget: Displays the Summary board that shows the songs you marked with Like and the playback history, and the Photo frame that shows photos.
3 Source launcher panel	Allows you select a source.
4 Network contents panel	Allows you to select a network-related application.

Source launcher panel and Network contents panel

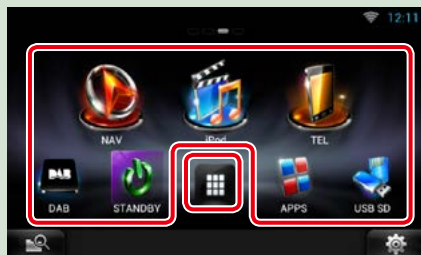

(Shortcut)

You can register sources and applications you use frequently so that you can start them quickly.

(All source list/ All apps list)

Displays all sources and applications.

All source list/ All apps list

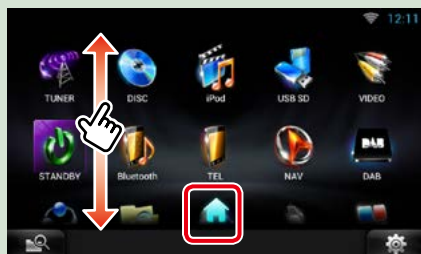







(All source list/ All apps list)

You can scroll the list screen by flicking the screen up/down.

(Home)

Returns to the Source launcher panel or the Network contents panel.

From All source list, you can perform the following functions.

Function	Icon	Operation
Switch the audio source	  etc.	Touch the icon of the desired source.
Switch the video source	  etc.	Touch the icon of the desired video source.
Display navigation screen (DNN9250DAB/ DNN6250DAB)	 or 	Touch [NAV] or navigation information.
Turn off all audio function		Touch [STANDBY].

Moving or deleting of an icon on the Source launcher panel and Network contents panel

- 1 Touch and hold the icon.
- 2 Drag the icon to the desired position or Recycle Bin.



Adding of a shortcut icon to Source launcher panel or Network contents panel

- 1 Touch [] in Source launcher panel or Network contents panel.
- 2 Touching the icon continuously to display the Source launcher panel or Network contents panel screen.
- 3 Drag the icon to an empty space.



Media panel

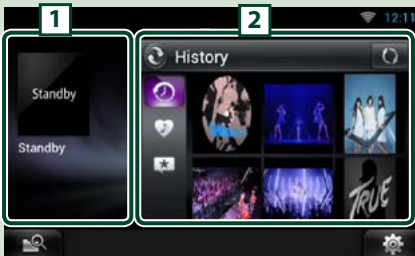

1 Now playing widget

Displays the title of the song being played or the name of the station you are listening to, and allows you to perform simple operations. See [Now playing Widget \(P.58\)](#).

2 Media widget

Touching [] allows you to switch among Summary Board, and photo frame.

See [Summary Board Widget \(P.60\)](#),
[Photo Frame Widget \(P.61\)](#).

Service panel



1 Weather widget

DNN9250DAB/ DNN6250DAB:
Displays the today's weather forecast. See [Weather Widget \(P.44\)](#).

DNR8025BT: Displays the clock and date.

2 Network widget

Touching [] allows you to switch between Schedule, RSS, and SNS.

See [Today Widget \(P.47\)](#), [SNS Widget \(P.47\)](#), [RSS Widget \(P.48\)](#).

Change the skin for home screen

You can select a home screen skin from 3 types.

1 Press the <MENU> button.

2 Touch [ Theme].



3 Select a skin.

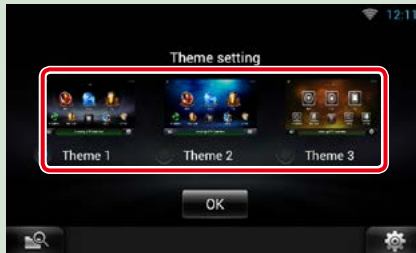

4 Touch [OK].

Common Operation

Introduces the common operation.

General

There are some functions which can be operated from most screens.



Quick menu screen





(Mixed Media Search)

Touch to display the Mixed Media Search screen. [\(P.62\)](#)

(Quick menu)

Touch to display the quick menu. The content of the menu are as follows.

-  : Displays the SETUP Menu screen.
-  : Displays the Audio Control Menu screen.
-  : Displays the control screen of current source. Icon feature differs depending on the source.

List screen

There are some common function keys in the list screens of most sources.

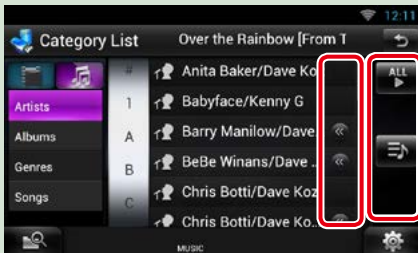

(Scroll)

Touch to scroll through texts on the display.

etc.





Touch keys with various functions are displayed here.

Displayed keys differ depending on the current audio source, status, etc.

For examples of functions of each key, refer to the table below.



Returns to previous screen.

Key	Function
	Lists all the music in the lower hierarchy.
	Moves to the upper hierarchy.
	Displays current category folder.
	Displays music/movie file list.

Continued

Flick scrolling

You can scroll the list screen by flicking the screen up/down or right/left.

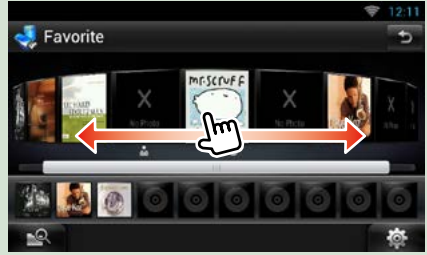
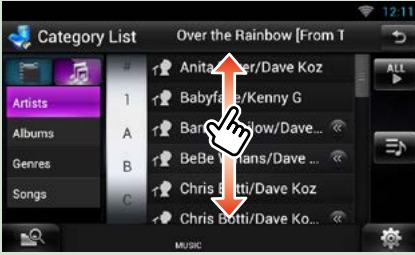

Navigation Operation (DNN9250DAB/ DNN6250DAB)

For details on the navigation function, please refer to the Navigation Instruction Manual.

Display the navigation screen

DNN9250DAB

- 1 Press the <NAV> button.

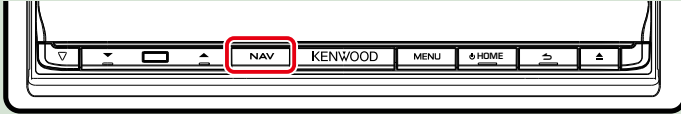

The navigation screen appears.

DNN6250DAB

- 1 Press the <HOME> button.



- 2 Select the Source launcher panel.

- 3 Touch [ NAV].

The navigation screen appears.

Control audio from the navigation screen

You can control audio sources while the navigation screen is displayed.

Also, you can view the navigation information while the source control screen is displayed.

1 Touch the information bar.



The navigation screen with audio information appears.

2 Touch [] or [] in the navigation screen.



Touching this area displays the audio screen.

: Displays the navigation and control keys of the current source.



: Displays the navigation and current video playback display.



NOTE

- The screen switches between playback screen and camera view each time the viewing area is touched.
- Touching the source icon in the bottom of the screen displays the full audio screen.
- Streaming Video and AUPEO! just plays music. You cannot control it and watch video.

● To return to the full navigation screen:

Touch [].

NOTE

- For details on control keys, refer to the instructions in each section.

Trip log function

You can upload the routes you traveled and the songs you listened to the Route Collector site so that you can confirm them later.

Precaution

- Trip log function can be used to log information such as routes you have traveled and songs you have listened to. Such information is uploaded to our Route Collector site, for later access by you through your computer. Non-personal data from this log is also kept and used by us for statistical purposes to improve the quality of our products. By selecting to use this function, you are accepting use of the data for such statistical purposes. This is an optional function that can be activated at your sole option and responsibility the procedures set forth in the left column.

1 Press the <MENU> button in the navigation screen or source control screen.

2 Touch [ Triplog On].

3 Touch [Yes].

When the Trip log is active, "" appears in the status bar.

NOTE

- You must have a connection with the internet using Wi-Fi.
- You can use the Trip log function when you have logged in the system as Owner or User.

Where To function

You can set the destination of the navigation easily by setting the destination of the Route Collector site from your PC or your smartphone.

1 Log in to Route Collector site by the owner account.

<http://www.route-collector.com/>

2 Set the destination in the Route Collector site.

3 You will be notified by "" icon on the status bar.

4 Drag the status bar downward. Touch [].

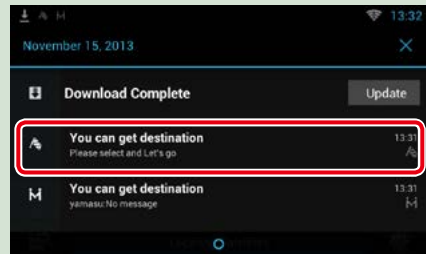

It will be set as the destination of the navigation.

5 Touch [GO] to start the route guide.







NOTE

- You can set a user account when you have logged in the Owner.
- You must have a connection with the internet using Wi-Fi.
- For the operation of the Route Collector site refer to the instruction in its website.

Come Here function

When you go to pick up your family or friends, send them the mail to decide the meeting point. After they enter the meeting point you can easily set it as the destination of your navigation.

- 1 Press the <HOME> button.
- 2 Flick the screen left or right to select the Network contents panel.
- 3 Touch [].
- 4 Touch [ SNS].
- 5 Touch [ (mail)].
- 6 Touch [].

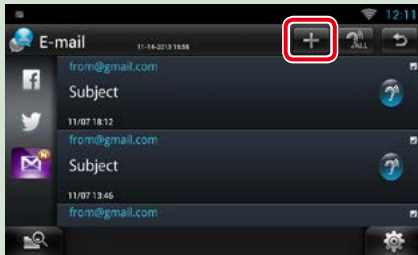

- 7 Touch [].

The address for setting the meeting point is added in the text part.

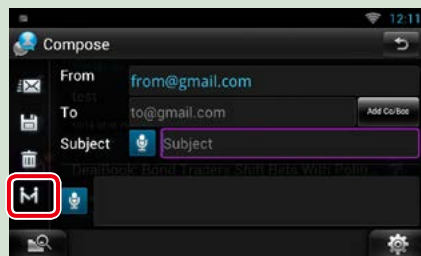

- 8 Enter the address, subject, etc. to complete the mail and send it.
- 9 Your family or friend will enter the meeting point.

Check the address in the mail, register as the meeting point and press Send.

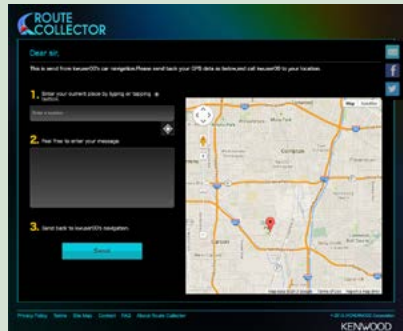

- 10 You will be notified by the "M" icon on the status bar when they enter the meeting point.
- 11 Drag the status bar downward. Touch [].

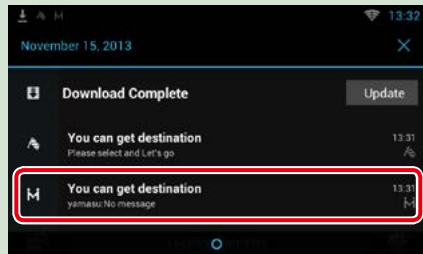

It will be set as the destination of the navigation.

- 12 Touch [GO] to start the route guide.

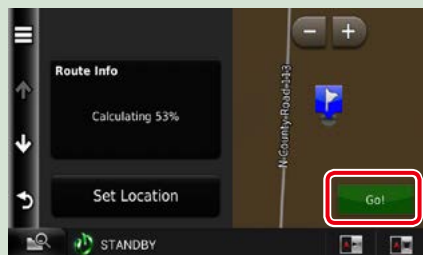

NOTE

- You must have a connection with the internet using Wi-Fi.
- The address of the meeting point is effective only 2 hours after adding the address. After that you can not enter it.
- Come Here function can be used for one person (one meeting point) at a time.

Tracking function

When you upload the location of you car to the Route Collector site, you can check it in case your car is stolen.

Precaution

- Tracking function is a handy function to be used for the primary purpose of tracking the location of your vehicle. This function can also be used for secondary purposes, at your sole option and responsibility. In any event, we cannot accept any responsibility for any results of your use of the function, for whatever purpose. Should you select to use this option, please activate the function through the procedures set forth in the left column.

1 Log in to Route Collector site by the owner account.

<http://www.route-collector.com/>

2 Set to ON the Tracking function in the Route Collector site.

You can check the location of your car in the Route Collector site.

NOTE

- You must have a connection with the internet using Wi-Fi.
- You can set this function and check the location of you car only when you log in by the owner account.
- For the operation of the Route Collector site refer to the instruction in its website.

Network Setup

You can not use Hi-Fi setup and Wi-Fi Hotspot setup at the same time. You can make it effective either Wi-Fi or Wi-Fi Hotspot.

• [Wi-Fi Setup \(P.34\)](#)

• [Wi-Fi Hotspot Setup \(P.36\)](#)

Wi-Fi Setup

You can connect to a Wi-Fi access point to connect to Internet.

Preparation

- Make preparations for using the Wi-Fi access point for Internet connection through use of the tethering function of the smartphone.
- Set to OFF the Wi-Fi Hotspot in [Wi-Fi Hotspot Setup \(P.36\)](#).

1 Press the <HOME> button to display the Home screen.

Note

- To display the Network contents panel, Press the <HOME> button again.

2 Press the <MENU> button.

3 Touch [Setting].



4 Slide Wi-Fi to ON.

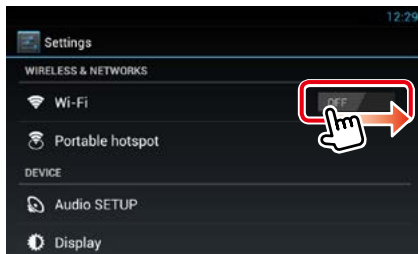

5 Touch [Wi-Fi].

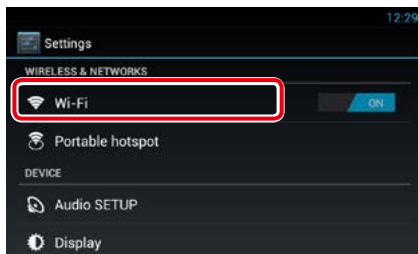

6 Select the Wi-Fi access point to register from the list.

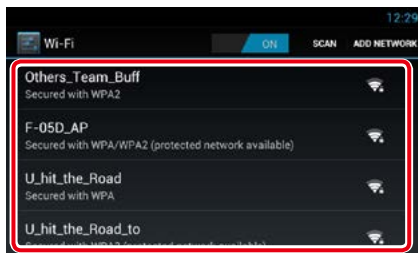

7 Enter the Password.



8 Touch [Connect].

Register the Wi-Fi access point manually

1 Touch [ADD NETWORK].



2 Enter the SSID code.

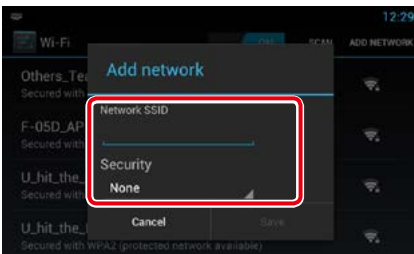

3 Select the security.

4 Enter the security code.

5 Touch [SAVE].

Confirm the MAC address

1 Press the <MENU> button.

2 Touch [Advanced].

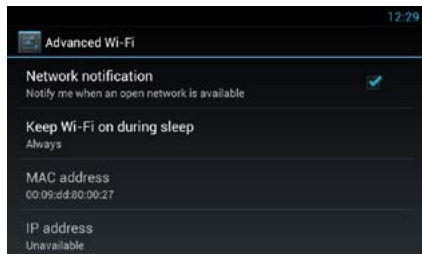
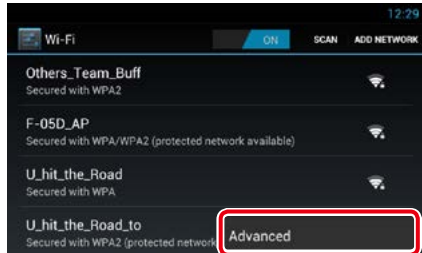

3 Press the <↩> button.

Wi-Fi Hotspot Setup

If there is no Wi-Fi access point, this unit becomes a Wi-Fi access point. You can connect your smartphone and your tablet PC, and enjoy Kenwood Wireless Link function. [\(P.92\)](#)

Preparation

- When Wi-Fi Hotspot is in use you can not connect to the Internet via Wi-Fi.
- Set to OFF the Wi-Fi in [Wi-Fi Setup \(P.34\)](#).

1 Press the <HOME> button to display the Home screen.

Note

- To display the Network contents panel, Press the <HOME> button again.

2 Press the <MENU> button.

3 Touch [Setting].



4 Touch [Portable hotspot].

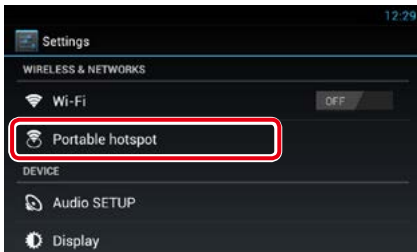

5 Touch [Configure Wi-Fi hotspot].



6 Enter the SSID code. Select the security. Enter the password.



When you check Show password, the password that you set is displayed.

7 Touch [Save].

8 Touch [Portable Wi-Fi hotspot].



This unit works as the Wi-Fi access point.

Clock and Date Setup

Clock and Date Setup

- 1 Press the <HOME> button to display the Home screen.

Note

- To display the Network contents panel, Press the <HOME> button again.

- 2 Press the <MENU> button.
- 3 Touch [Setting].



- 4 Touch [Date & time].

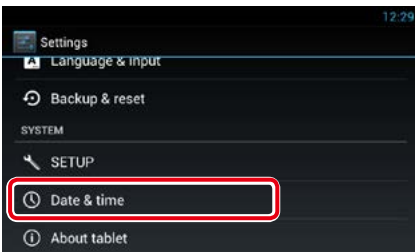

- 5 Set each item as follows.

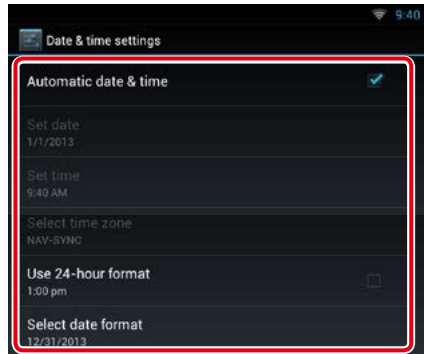

- 6 Press the <↵> button.

Adjust the date and time manually.

- 1 Touch [Automatic date & time] to remove the check.

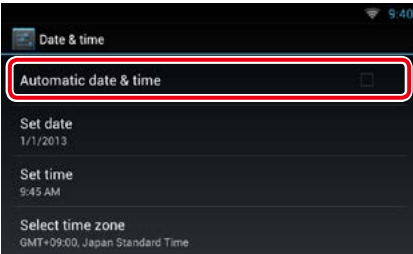

- 2 Touch [Select time zone].

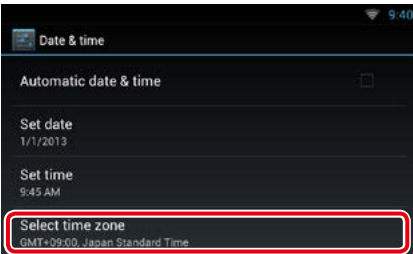

- 3 Select a time zone.

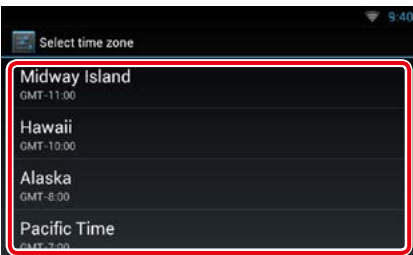

- 4 Touch [Set date].

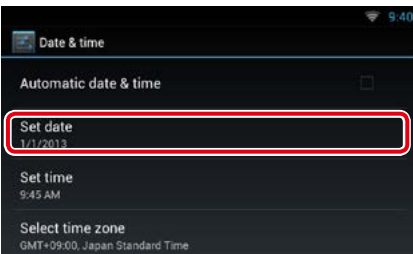

- 5 Adjust the date.

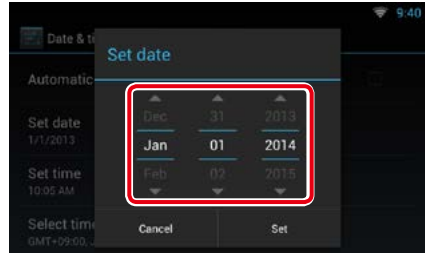

- 6 Touch [Set].

- 7 Touch [Set time].

- 8 Adjust the time.

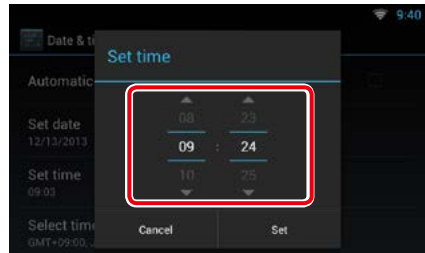

- 9 Touch [Set].

- 10 Press the < > button.

Account Setup

About Account

To use this unit, you must register an account.

Types of accounts

You can create accounts to maintain privacy when using the mail feature or social media.

Administrator

As Administrator, you can create an owner account and perform initial setup.

You can log in to the system if you have not created an owner account.

Guest

An account for guests such as your friends.

The guest can operate this unit, but cannot use the functions related to mail, social media, and Route Collector site.

Owner

The account for the person who manages this unit.

The owner can use the functions related to mail, social media, and Route Collector site.

You can register users such as your family.

User

The account for the user of this unit.

The user can use the functions related to mail, social media, and Route Collector site.

You can register up to 4 user accounts.

Account registration procedure

1 Create an account in the Route Collector site.

Create an account referring to [Create User Account \(P.40\)](#) or the Route Collector site.

<http://www.route-collector.com/>

2 Register the account in this unit.

To register an Owner account, refer to [Set Owner Account \(P.41\)](#).

To register an User account, refer to [Set User Account \(P.42\)](#).

3 Switch between login accounts.

See [Switch the User Login \(P.42\)](#).

Create User Account

To use this unit, you need to create an account in the Route Collector site.

Preparation

- To register yourself in the Route Collector site as a user, you need a mail address.
- You can register yourself via the Web.
<http://www.route-collector.com/>
- This step may be skipped if you have already registered yourself in the Route Collector site.

1 Press the <HOME> button to display the Home screen.

2 Press the <MENU> button.

3 Touch [Account].

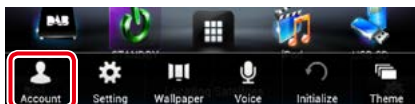

4 Touch [Create Account].

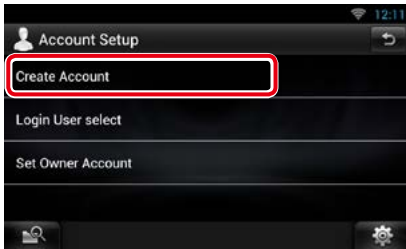

5 Enter account information.



You cannot register an account which has already been used. Register another account name.

6 Touch [OK].

The account is temporarily registered in the Route Collector site.

7 Activate the account.

A confirmation mail is sent to the registered mail address. Open the indicated URL to complete account registration.

Set Owner Account

You can register an owner account for the person who manages this system.

Preparation

- You must have a connection with the internet using Wi-Fi. See [Wi-Fi Setup \(P.34\)](#).
- First create an account in the Route Collector site. See [Create User Account \(P.40\)](#).
- If you have not created an owner account, log in to the system as Administrator.
- If you have created an owner account, log in to the system after account resetting.

1 Press the <HOME> button to display the Home screen.

2 Press the <MENU> button.

3 Touch [Account].

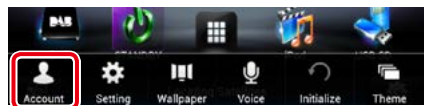

4 Touch [Set Owner Account].

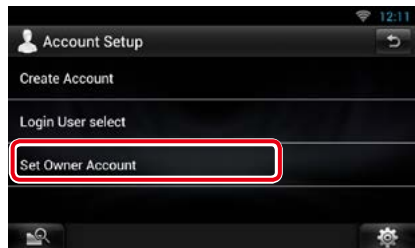

5 Enter account information.



Enter the information registered in the Route Collector site.

6 Touch [OK].

Set User Account

You can register a user account for the user of this navigation system.

Preparation

- You must have a connection with the internet using Wi-Fi. See [Wi-Fi Setup \(P.34\)](#).
- First create an account in the Route Collector site. See [Create User Account \(P.40\)](#).
- You can set a user account when you have logged in the Owner.

1 Press the <HOME> button to display the Home screen.

2 Press the <MENU> button.

3 Touch [Account].

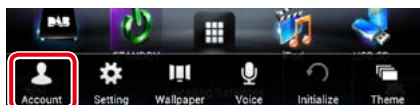

4 Touch [Set Account].

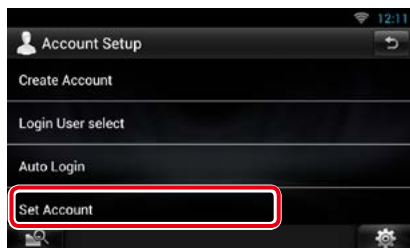

5 Enter account information.



Enter the information registered in the Route Collector site.

6 Touch [OK].

Switch the User Login

You can switch to a different account from the one currently logged in.

1 Press the <HOME> button to display the Home screen.

2 Press the <MENU> button.

3 Touch [Account].

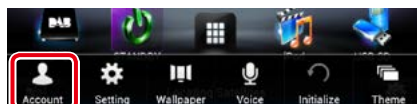

4 Touch [Login User select].

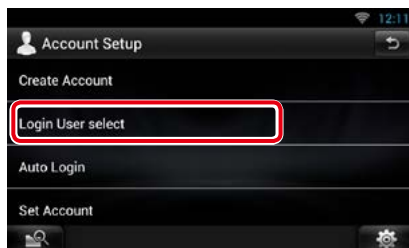

5 Select an account.

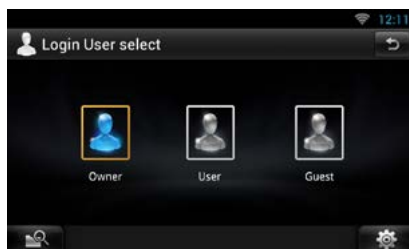

6 Enter the password.

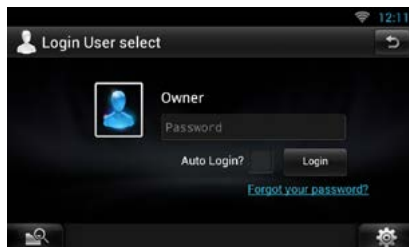

Delete User Account

You can delete a previously registered user account.

Preparation

- You can set a user account when you have logged in the Owner.

- 1 Press the <HOME> button to display the Home screen.
- 2 Press the <MENU> button.
- 3 Touch [Account].

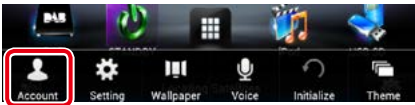

- 4 Touch [Delete Account].



- 5 Select an account.

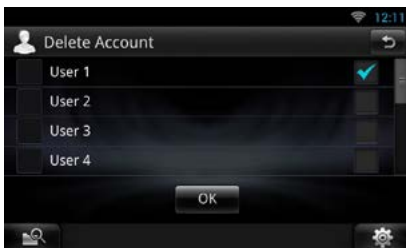

- 6 Touch [OK].
Confirmation screen appears.
- 7 Touch [Yes].

Reset Owner Account

You can delete previously registered owner and user accounts.

Preparation

- You can set a user account when you have logged in the Owner.

- 1 Press the <HOME> button to display the Home screen.
- 2 Press the <MENU> button.
- 3 Touch [Account].

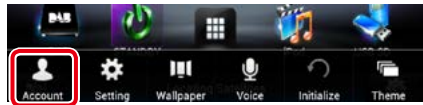

- 4 Touch [Reset Account].

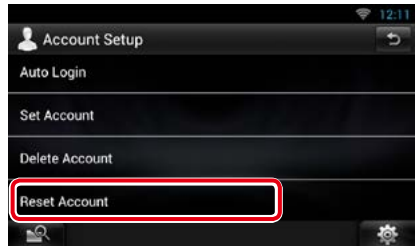

- 5 Enter the owner account's password.



- 6 Touch [OK].
Confirmation screen appears.
- 7 Touch [Yes].

Note

- The data, log, and settings used in the account are deleted.

Widget and Application Operation

Weather Widget

Displays the weather forecast for the selected region.

Preparation

- You must have a connection with the internet using Wi-Fi. See [Wi-Fi Setup \(P.34\)](#).
- You can use this feature for 2 years after registration of the owner account. To use it continuously, a usage fee is required. For details, see web site of Route Collector.

<http://www.route-collector.com/>

- 1 Press the <HOME> button.
- 2 Flick the screen left or right to select the Service panel.

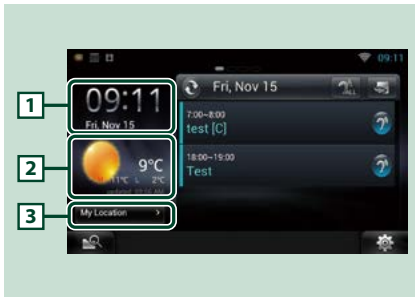

1 Time & Date

Displays the current time and date.

2 Weather information

Displays the weather forecast for the selected region.

Touching this starts the weather application.

3 City information

Displays the selected region.

Touching this displays a region selection screen. See [City select \(P.44\)](#).

City select

- 1 Touch [(City name)] in the Weather Widget.

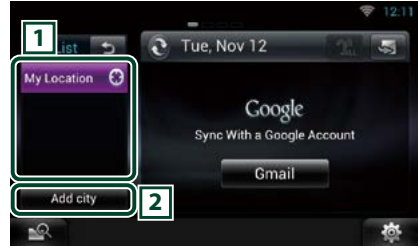

1 City list

Displays a region list.

Touching this displays the selected region.

2 [Add City]



Starts the weather application to add the region. See [Add a City \(P.45\)](#).

Weather Application

Displays the weather forecast for the selected region.

Preparation

- You must have a connection with the internet using Wi-Fi. See [Wi-Fi Setup \(P.34\)](#).
- You can use this feature for 2 years after registration of the owner account. To use it continuously, a usage fee is required. For details, see web site of Route Collector.
<http://www.route-collector.com/>

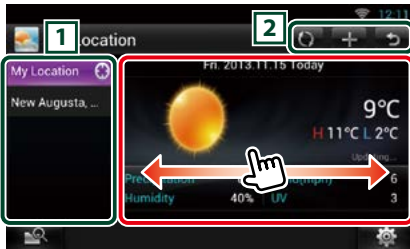

- 1 Press the <HOME> button.
- 2 Flick the screen left or right to select the Network contents panel.
- 3 Touch [].
- 4 Touch [ Weather].
- 5 Perform desired operation as follows.



1 City list

Displays a region list.
Touching this displays the selected region.

2

- : Reads information again.
- : Adds a region.
- : Terminates the application.

(Weather information)

Displays the today's weather forecast and the weather forecast for the next 6 days.

Menu

- 1 Press the <MENU> button.

Delete

Deletes a region from the City list. See [Delete City \(P.46\)](#).

Setting

Allows you to set the information update interval, etc. See [Weather setup \(P.46\)](#).

Add a City

Adds a region to the City list.

- 1 Touch [].
- 2 Search for a region.

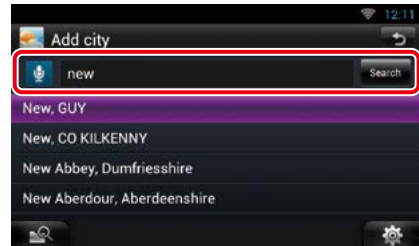

(Voice recognition)

You can enter a region using the voice recognition function. When "Speak now" is displayed, pronounce the region name.

[Search]

Search starts.

- 3 Select a region.

Touching the region adds it to the list, and displays the weather forecast.

Delete City

You can delete a region from the City list.

- 1 Press the <MENU> button.
- 2 Touch [Delete] in the Menu.
- 3 Delete the region.

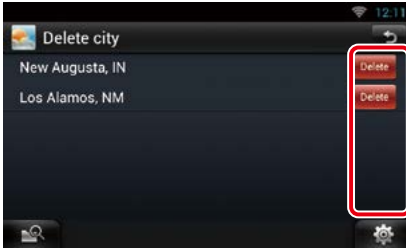

- 4 Touch [Yes].
- 5 Touch [↩].

Weather setup

Performs setup when using Weather Application.

- 1 Press the <MENU> button.
- 2 Touch [Setting] in the Menu.
- 3 Select an option as follows.

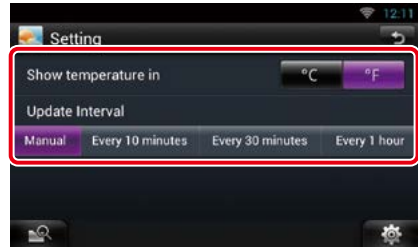

Show temperature

Select a temperature scale.

Update interval

Set an information update interval.

- 4 Touch [↩].

Today Widget

You can display the today's schedule registered in Google Calendar.

Preparation

- To use this service, a Google account is required.
- You can use a user account when you have logged in the Owner or User.

- 1 Press the <HOME> button.**
- 2 Flick the screen left or right to select the Service panel.**
- 3 Touch [RSS].**
- 4 Select the Today Widget.**

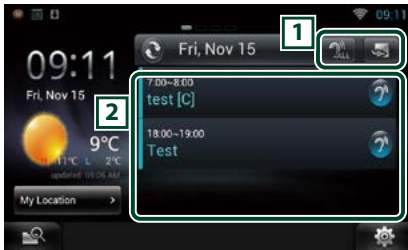

1

- : Starts the schedule application.
- : Reads out all schedules in an auditory fashion.
- : Switches to RSS or SNS.

2 Schedule list

Displays the today's schedule registered in Google Calendar.

Touching it displays the event view.

- : Reads out the schedule in an auditory fashion.

SNS Widget

You can use Facebook, Twitter, Gmail, and email (IMAP).

Preparation

- To use each service, the email, Google, Facebook, Twitter or email account is required.
- You can use a user account when you have logged in the Owner or User.

- 1 Press the <HOME> button.**
- 2 Flick the screen left or right to select the Service panel.**
- 3 Touch [RSS].**
- 4 Select the SNS Widget.**



1

- : Starts the SNS application.
- : Reads out all contents in an auditory fashion.
- : Switches to the schedule or RSS.

2 Category

Select a service category.

3 SNS article list

Displays the contents selected in Category in a new order.

Touching this starts the SNS application and displays its contents.

When the latest information is displayed at the top, sliding the list allows you to update the information.

- : Reads out the SNS contents in an auditory fashion.

RSS Widget

Displays the RSS news.

- 1 Press the <HOME> button.
- 2 Flick the screen left or right to select the Service panel.
- 3 Touch [RSS].
- 4 Select the RSS Widget.

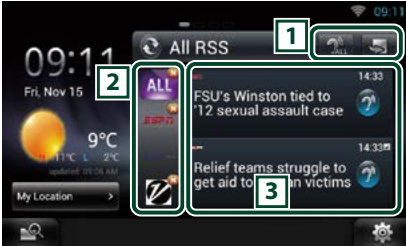

1

: Starts the RSS application.

: Reads out all the contents in an auditory fashion.

: Switches to the schedule or SNS.

2 Category

Select a service category.

3 RSS article list

Displays the contents selected in Category in a new order.

Touching this starts the RSS application and displays its contents.

When the latest information is displayed at the top, sliding the list allows you to update the information.

: Reads out the RSS contents in an auditory fashion.

Schedule Application

You can edit schedules on the internet. In addition, you can also synchronize the schedule with Google Calendar.

Preparation

- You must have a connection with the internet using Wi-Fi. See [Wi-Fi Setup \(P.34\)](#).
- To use Google Calendar, a Google account is required.
- You can use a user account when you have logged in the Owner or User.

Register an account

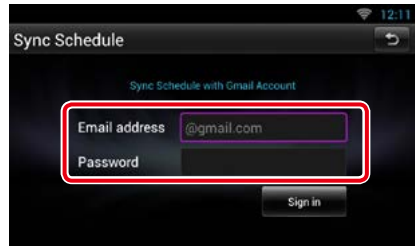

Register account information for synchronization with the Google account.

- 1 Press the <HOME> button.
- 2 Flick the screen left or right to select the Network contents panel.
- 3 Touch [Schedule].
- 4 Touch [Schedule].
- 5 Touch [Gmail].
- 6 Enter the Email address and Password.





- 7 Touch [Sign in].

Schedule Operation

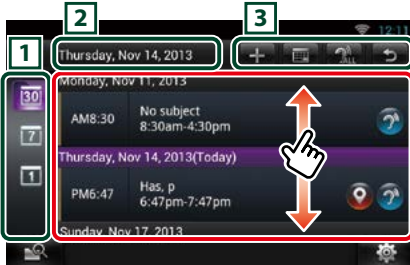
- 1 Press the <HOME> button.
- 2 Flick the screen left or right to select the Network contents panel.
- 3 Touch [].
- 4 Touch [ Schedule].
- 5 Perform desired operation as follows.







View category

-  : Displays agendas.
-  : Displays the weekly schedule.
-  : Displays the daily schedule.

Date information

Displays the date of the displayed schedule.
Touching this displays the date of the schedule to be displayed.

-  : Add a schedule.
-  : Displays the today's schedule.
-  : Reads out all schedules by voice.
-  : Terminates the application.

(Schedule list)

Displays a schedule.
Touching this displays details of the schedule.
 : Reads out the content of the schedule in an auditory fashion.

6 Detailed schedule view.

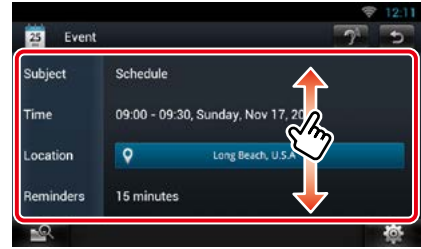

(Text-to-speech)

Reads out the content of the schedule by voice.

Menu

- 1 Press the <MENU> button.
Agenda view/ Week view/ Day view

Sign out

Logs out from the current account.

Event view

Edit event

Edit schedule.

Delete event

Deletes schedule.

When a confirmation screen appears, touch "Yes".

Add event

Adds an event to the schedule.

- 1 Touch [] in the Schedule application.
- 2 Enter your schedule.

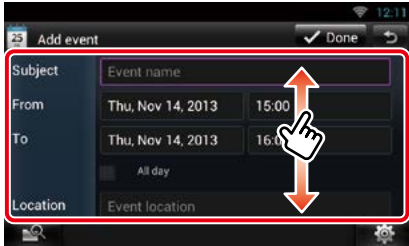

Enter an event name, date and time, description, etc.

- 3 Add an event.

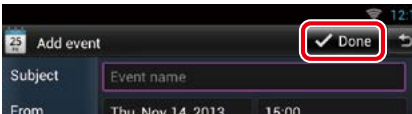

Synchronizes the schedule with Google Calendar if used.

Notification

Displays a notification icon in the status bar when the set time is reached.

- 1 Drag the status bar downward.



- 2 Touch [].

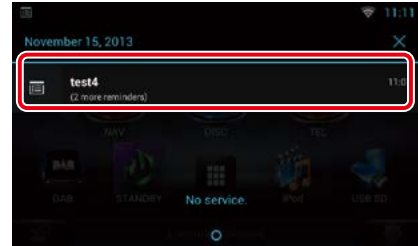

- 3 Touch the subject to display details.

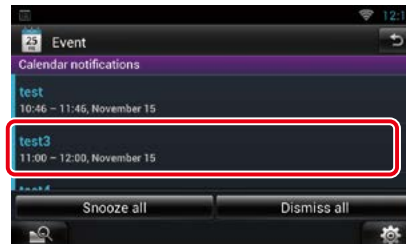

The Schedule application starts to display details.

Facebook (SNS Application)

Displays the screen for using Facebook.

Preparation

- You must have a connection with the internet using Wi-Fi. See [Wi-Fi Setup \(P.34\)](#).
- To use a Facebook service, the corresponding account is required.
- You can use a user account when you have logged in the Owner or User.

Register an account

- 1 Press the <HOME> button.
- 2 Flick the screen left or right to select the Network contents panel.
- 3 Touch [].
- 4 Touch [ SNS].
- 5 Touch [ (Facebook)].
- 6 Touch [Sign in].
- 7 Enter the Email address/Phone and Password.

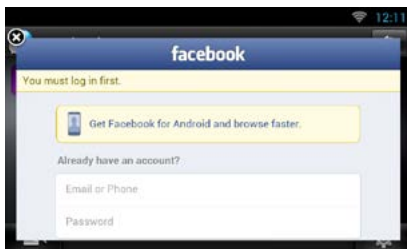

- 8 Touch [Log in].

Operation

- 1 Press the <HOME> button.
- 2 Flick the screen left or right to select the Network contents panel.
- 3 Touch [].
- 4 Touch [ SNS].
- 5 Touch [ (Facebook)].

6 Perform desired operation as follows.



1

-  : Create a new article.
-  : Posting the current place.
-  : Reads out all articles by voice.
-  : Terminates the application.

2 Article list

Displays an article or message.

Touching this displays details.

While the latest information is displayed at the top, sliding the list down updates the information.

-  : Reads out the article by voice.

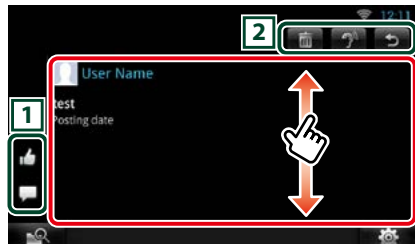

7 Detailed article or message view.



1

-  : Votes as "Like".
-  : Posts a comment.

2

-  : Deletes an article. When the confirmation screen appears, touch "Ok".
-  : Reads the content of the comment by voice.
-  : Returns to previous screen.

Menu

- 1 Press the <MENU> button.

Article list view

Setting

Set an update interval.

Sign out

Logs out from the current account.

Add to post

Create an article to be posted to the SNS service of the selected category.

- 1 Touch [] in the SNS application.
- 2 Create an article to post.



1

Enter an article to post.

: Enter a comment using the voice recognition function. When “Speak now” appears, speak the comment.

[Post] : Posts the article.

2

: Post photo.

: Returns to previous screen.

3

Select a fixed phrase.

Twitter (SNS Application)

Displays the screen for using Twitter.

Preparation

- You must have a connection with the internet using Wi-Fi. See [Wi-Fi Setup \(P.34\)](#).
- To use a Twitter service, the corresponding account is required.
- You can use a user account when you have logged in the Owner or User.

Register an account

- 1 Press the <HOME> button.
- 2 Flick the screen left or right to select the Network contents panel.
- 3 Touch [].
- 4 Touch [SNS].
- 5 Touch [(Twitter)].
- 6 Touch [Sign in].
- 7 Enter the Username/email and Password.

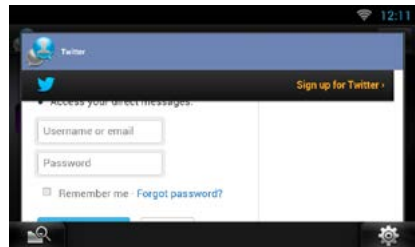



- 8 Touch [Authorize app].

Operation

- 1 Press the <HOME> button.
- 2 Flick the screen left or right to select the Network contents panel.
- 3 Touch [].
- 4 Touch [ SNS].
- 5 Touch [ (Twitter)].
- 6 Perform desired operation as follows.



1

-  : Create a new article.
-  : Posting the current place.
-  : Reads out all articles by voice.
-  : Terminates the application.



2 Article list

- Displays an article or message.
- Touching this displays details.
- While the latest information is displayed at the top, sliding the list down updates the information.
-  : Reads out the article by voice.

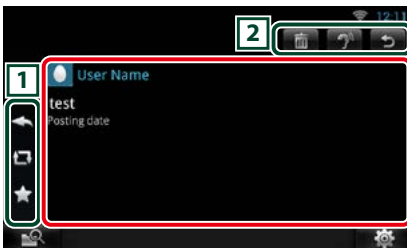

7 Detailed article or message view.



1

-  : Create a reply.
-  : Create a ReTweet.
-  : Adds to Favorites.

2

-  : Delete the Tweet.
-  : Reads the content of the comment by voice.
-  : Returns to previous screen.

Menu

- 1 Press the <MENU> button.

Article list view

Setting

Set an update interval.

Sign out

Log out from the current account.

Add to post

Create an article to be posted to the SNS service of the selected category.



- 1 Touch [] in the SNS application.
- 2 Create an article to post.



1

- Enter an article to post.
-  : Enter a comment using the voice recognition function. When "Speak now" appears, speak the comment.
- [Post] : Posts the article.

2

-  : Post current location.
-  : Returns to previous screen.

3

Select a fixed phrase.

E-mail (SNS Application)

Displays the screen for using E-mail.

Preparation

- You must have a connection with the internet using Wi-Fi. See [Wi-Fi Setup \(P.34\)](#).
- To use a Google or email service, the corresponding account is required.
- You can use a user account when you have logged in the Owner or User.

Register an account

- 1 Press the <HOME> button.
- 2 Flick the screen left or right to select the Network contents panel.
- 3 Touch [].
- 4 Touch [ SNS].
- 5 Touch [ (mail)].
- 6 Touch [Sign in].
- 7 Touch [Gmail].
- 8 Enter the Email and Password.

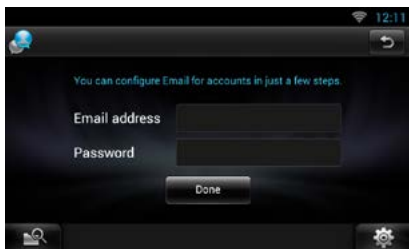



- 9 Touch [Next].

NOTE

- You can register Email (IMAP). Select [Other] in step 7, and enter necessary data according to the displayed messages.

Operation

- 1 Press the <HOME> button.
- 2 Flick the screen left or right to select the Network contents panel.
- 3 Touch [].
- 4 Touch [ SNS].
- 5 Touch [ (mail)].
- 6 Perform desired operation as follows.



- 1
-  : Create a new article.
 -  : Reads out all articles by voice.
 -  : Terminates the application.

2 Inbox list

Displays an article or message.

Touching this displays details.



While the latest information is displayed at the top, sliding the list down updates the information.

-  : Reads out the article by voice.

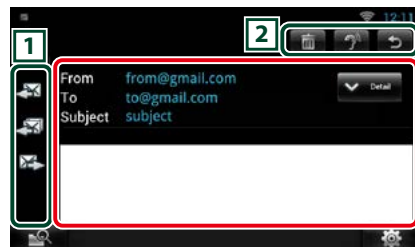

7 Detailed article or message view.



1

- : Creates a reply mail.
- : Creates a reply mail for all.
- : Creates a forwarded mail.

2

- : Deletes an article. When the confirmation screen appears, touch "Ok".
- : Reads the content of the comment by voice.
- : Returns to previous screen.

Menu

1 Press the <MENU> button.

Inbox list view

Setting

Set an update interval.

Account

Select the account and label to be displayed.

- ① Select an account.
- ② Select a label.

Add account

Register a new account.

Delete account

Delete a registered account.

Select the account to delete by putting a checkmark, and then touch [OK].

Add to post





Create an article to be posted to the SNS service of the selected category.

1 Touch [+] in the SNS application.

2 Create an article to post.



1

- : Sends the mail.
- : Stores the mail temporarily.
- : Deletes the mail.
- : Enters the address of the meeting point for Come Here function. See [Come Here function \(P.32\)](#). (DNN9250DAB/DNN6250DAB)

2

- : Returns to previous screen.

3

Create a mail message to send.

- : Enter a comment using the voice recognition function. When "Speak now" appears, speak the comment.



[Add Cc/Bcc] : Displays cc and Bcc.

RSS Application

Displays an RSS feed.



Preparation

- You must have a connection with the internet using Wi-Fi. See [Wi-Fi Setup \(P.34\)](#).
- You can use a user account when you have logged in the Owner or User.

- 1 Press the <HOME> button.
- 2 Flick the screen left or right to select the Network contents panel.
- 3 Touch [].
- 4 Touch [ (RSS)].
- 5 Perform desired operation as follows.



1

- : Adds an RSS feed. See [Add RSS feed \(P.57\)](#)
- : Reads out all articles by voice.
- : Terminates the application.

2 Category

Select the RSS feed to be displayed.

3 Article list

Display the article.

Touching this displays details.

While the latest information is displayed at the top, sliding the list down updates the information.

- : Reads out the article by voice.

6 Detailed article view.

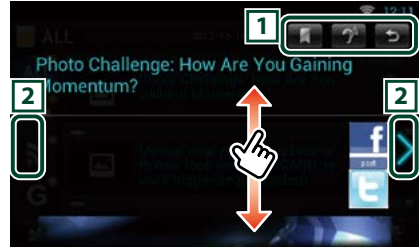

1

- : Registers the RSS feed in the bookmark of the Route Collector site. You can read it later in the Route Collector site.
- : Reads the content by voice.
- : Returns to previous screen.

2

Moves to the previous or next article.

Menu

- 1 Press the <MENU> button.

Article list view

Delete

Delete an RSS feed. See [Delete RSS feed \(P.57\)](#)

Setting

Set the update interval. See [RSS setup \(P.57\)](#)

Add RSS feed

Add an RSS feed.

- 1 Touch [**+**] in the RSS application.
- 2 Select a category.

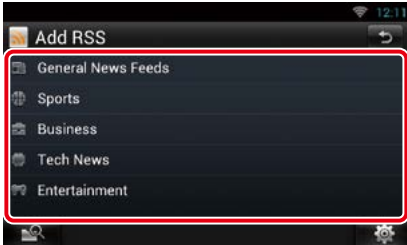

- 3 Touch [Add].

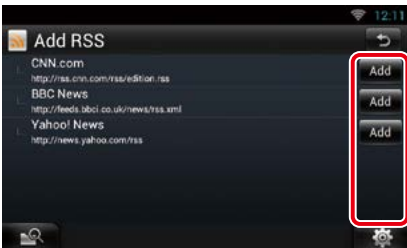

Note

- In order to add an selectable RSS feed, you need to edit it in the Route Collector site. See www.route-collector.com/

Delete RSS feed

Delete an RSS feed.

- 1 Press the <MENU> button.
- 2 Touch [Delete].

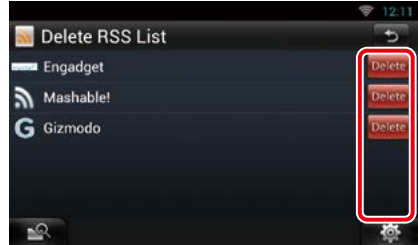

- 3 Touch [Yes] to confirm.

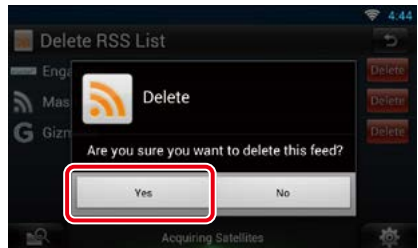

RSS setup

Performs setup when using RSS Application.

- 1 Press the <MENU> button.
- 2 Touch [Setting] in the Menu.
- 3 Select an option as follows.

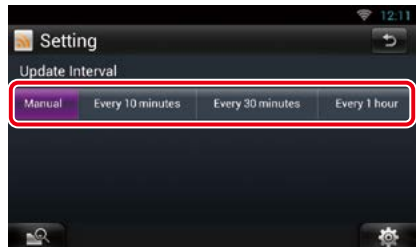

Update interval

Set the information update interval.

Now playing Widget

Displays the information about the song or station you are listening to, and allows you to perform simple operations.

- 1 Press the <HOME> button.
- 2 Flick the screen left or right to select the Media panel.

Media source such as CD or USB

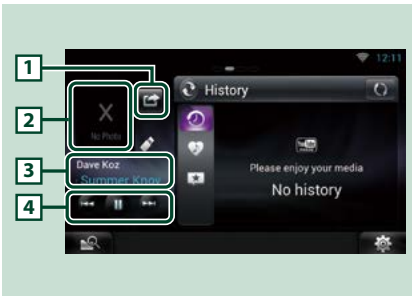

1 (I'm listening)

You can post the information about the song you are listening to, on twitter, Facebook. See [Posting the information about the song you are listening to \(P.59\)](#).

2 Album art

Touching Album art displays the Source control screen.

3 Information display

Displays the information (title, etc.) about the song being played.

4

Allow you to stop playback temporarily and select songs.

Radio source such as Radio

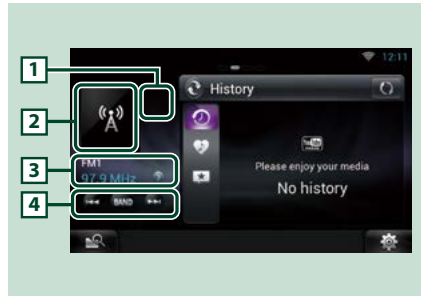

1 (I'm listening)

You can post the information about the song you are listening to, on twitter, Facebook. See [Posting the information about the song you are listening to \(P.59\)](#).

2 Artwork

Touching artwork displays the Source control screen.

3 Information display

Displays the band, frequency, etc.
Touching this displays the Preset list screen. See [Preset select \(P.59\)](#).

4

Allows you to select a band and a station.

Posting the information about the song you are listening to

You can post the information about the song you are listening to, on Twitter, Facebook, or Route Collector site.

1 Touch [].



2 Create the information you want to post.

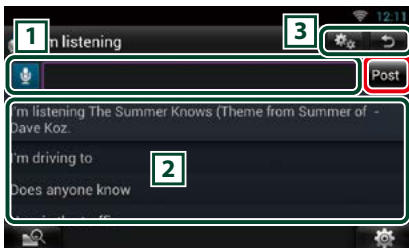

1 Enter the information you want to post.

 : Enter a comment using the voice recognition function. When "Speak now" is displayed, pronounce the comment.

[Post] : Posts the information.

2 Fixed phrase

Select the information about the song you are listening to and a fixed phrase.

3  : Select the service on which you want to post the information.
Select the service, and then touch [OK].

 : Returns to previous screen.

Preset select

1 Touch illustrated area.

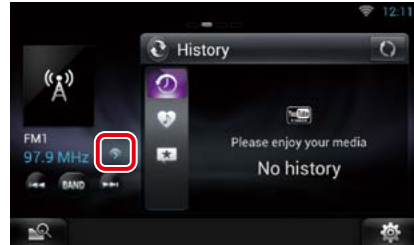

2 Select a station or channel from the list.

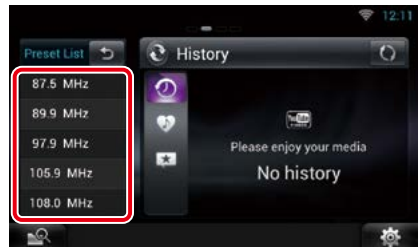

Summary Board Widget

Summary Board Widget shows your favorite songs, the playback history of YouTube, the charts information, etc.

Preparation

- You must have a connection with the internet using Wi-Fi. See [Wi-Fi Setup \(P.34\)](#).
- You can use a user account when you have logged in the Owner or User.
- When the Trip log function is turned on, information about the played content is displayed. See [Trip log function \(P.31\)](#).

- 1 Press the <HOME> button.**
- 2 Flick the screen left or right to select the Media panel.**
- 3 Touch [].**
- 4 Select the Summary Board Widget.**
- 5 Touch desired item.**

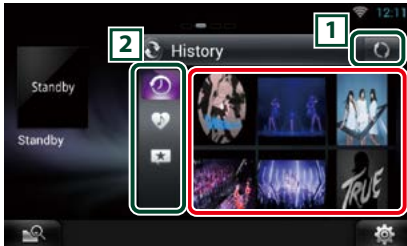

YouTube app starts and plays the song.

1

Update the history information.

 : Switches to Photo frame.

2 Category

Select the service category.



: Displays the playback history of YouTube.



: Displays the list of your favorite songs that you saved (liked).



: Count the contents which users marked "Like" and list up.



(Like/ Recommend)

Show the search result by artist name and title on YouTube.

Photo Frame Widget

You can display the photos stored in the USB memory or SD card as a slide show.

- 1 Press the <HOME> button.
- 2 Flick the screen left or right to select the Media panel.
- 3 Touch [].
- 4 Select the Photo Frame Widget.



1 Edit

Edit the photo to be displayed.

2 Picture

Sliding the photo vertically scrolls through photos.

: Switches to Summary Board.

- 1 Select the photo you want to display.

1 Touch [].

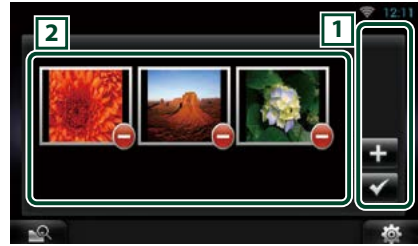

1

: Displays the screen for selecting the photo to be added.

: Ends editing, and returns to the Photo frame screen.

2 Thumbnail

Touch and hold the photo. When the photo shaking, drag the photo to change the order.

: Deletes the photo from the list.

2 Touch [].



3 Select a picture.



4 Touch [].

Mixed Media Search

You can search media like USB,iPod for the song by artist or album name and play it.

- 1 Touch [].
- 2 Select whether you search for the song by artist name  or album name  .
- 3 Enter the Artist or Album.

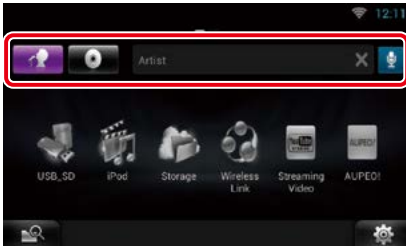

Enter the keyword using the voice recognition function. When "Speak now" is displayed, pronounce the keyword.

* You can use a user account when you have logged in the Owner or User.

- 4 Select a Source.



The source changes and playback starts.

DVD/Video CD (VCD) Operation

DVD/VCD Basic Operation

Most functions can be controlled from the source control screen and playback screen.

NOTE

- Set the remote controller mode switch to DVD mode before starting operation, see [Switching the operation mode \(P.145\)](#).
- The screen shot below is for DVD. It may be different from the one for VCD.

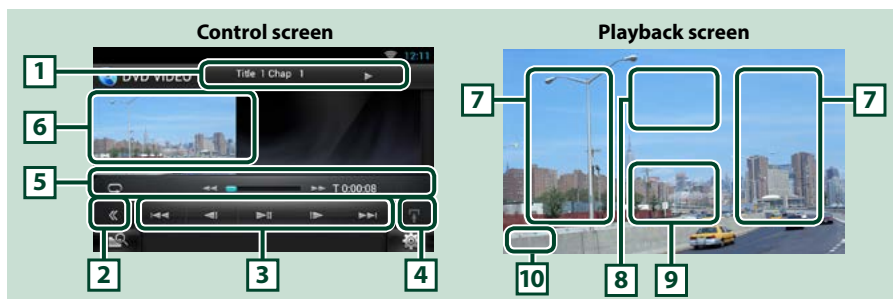

1 Information display

Displays the following information.

- **Title #, Chap #:** DVD title and chapter number display
- **Track #/Scene #:** VCD track or scene number display
*Scene # is displayed only when PBC is on.
- **▶, ▶▶, ▶▶▶, ■, etc.:** Current play mode display
The meanings of each icon are as follows; ▶ (play), ▶▶ (fast forward), ◀◀ (fast backward), ▶▶▶ (search up), ◀◀◀ (search down), ■ (stop), ■R (resume stop), || (pause), ▶▶ (slow playback), ◀◀ (slow reverse playback).

Touch this area to display the disc label name.

2 Multi function key

Touch to switch the multi function menu. For details on the menu, see [Multi function menu \(P.66\)](#).

3 Multi function menu







Various functions can be operated using keys in this menu. For details on the keys, see [Multi function menu \(P.66\)](#).

4 Control switching key

Unavailable in DVD/VCD source.

5 Sub function menu

The following functions can be performed by using keys in this area.

- **Repeats the current content:** Touch []. Each time you touch the key, repeat mode switches in the following sequence:
DVD: "title repeat" , "chapter repeat" , "function off"
VCD (PBC On): Does not repeat
VCD (PBC Off): "track repeat" , "function off"
- **Fast forward or fast backward:** Touch [] or []. Each time you touch the key, the speed changes; standard, 2 times, 3 times.
- **For confirmation of play time:** See ###:##.
DVD: You can switch the time display between title play time, chapter play time, and title remaining time. Each time you touch, the display switches between "T ###:##" (title play time display), "C ###:##" (chapter play time display), and "R ###:##" (title remaining time display).
As well as the time display, the bar indicating current location appears.
VCD (PBC off): You can also confirm disc remaining time by touching time display.
Each time you touch, the display switches between "P ###:##" (play time display) and "R ###:##" (disc remaining time).
- **For confirmation of current playing position:**
See the bar in center (DVD only). The bar does not appear while the remaining time is being displayed.

6 Movie display area

Touch to display Video screen.

7 Searching area

Touch to search the next/previous content.

Scrolling from center of display to left or right performs fast backward or fast forward. Each time you touch each area, the speed changes; standard, 2 times, 3 times. To stop fast backward/forward, touch center of the display.

8 Menu display area

This area functions differently depending on the current status.

- **During DVD playback:** Displays the Movie control screen. During the menu display, displays the highlight control screen.
- **During VCD playback:** Displays the Movie control screen. See [Zoom Control for DVD and VCD \(P.68\)](#).

9 Key display area

Touch to display the last control screen.

10 Screen setup display area

Touch and hold to display the screen control screen. See [Monitor Screen Setup \(P.124\)](#).

NOTE

- If you use a remote controller, you can jump directly to the desired video scene by entering the chapter number, scene number, play time, etc. [Direct search mode \(P.145\)](#).

Multi function menu

DVD

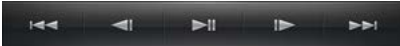

VCD



The functions of each key are as follows.

[<<] [>>]

Searches the previous/next content.

[▶||]

Plays or pauses.

[<|] or [>|] (DVD only)

Plays in slow motion forward or backward.

[■]

Stops playback. When touched twice, the disc is played from the beginning when you play it the next time.

[PBC] (VCD only)

Turn PBC on or off.

DVD Disc Menu Operation

You can set up some items in the DVD-VIDEO disc menu.

1 Touch illustrated area during playback.



Movie control screen appears.

2 Touch [Disc CTRL].

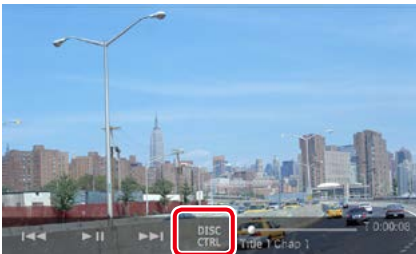

Menu Control screen appears.

3 Perform desired operation as follows.



Displays the top menu

Touch [Top].*

Displays the menu

Touch [Menu].*

Displays the previous menu

Touch [Return].*

Enters selected item

Touch [Enter].

Enables direct operation

Touch [Highlight] to enter the highlight control mode. See [Highlight control \(P.67\)](#).

Moves the cursor

Touch [▲], [▼], [◀], [▶].

*These keys may not function depending on the disc.

Highlight control

Highlight control lets you control the DVD menu by touching the menu key directly on the screen.

1 Touch [Highlight] in the Menu Control screen.

2 Touch desired item on the screen.



NOTE

- The highlight control is cleared automatically if you do not operate for a constant time.

DVD Play Mode Setting

You can select DVD play mode.

- 1 Touch [Next] in the Menu Control screen.



Menu Control 2 screen appears.

- 2 Touch the key which corresponds to desired setting item.



Switches the subtitle language

Touch [Subtitle]. Each time you touch this key, language is switched.

Switches the audio language

Touch [Audio]. Each time you touch this key, language is switched.

Controls zoom ratio

Touch [Zoom]. For details, see [step2 in Zoom Control for DVD and VCD \(P.68\)](#).

Switches the picture angle

Touch [Angle]. Each time you touch this key, picture angle is switched.

Exits menu control

Touch [Exit].

Displays the Menu Control 1 screen

Touch [Previous].

Zoom Control for DVD and VCD

You can enlarge Playback screen for DVD and VCD.

- 1 For VCD, touch illustrated area during playback.



Movie control screen appears.

- 2 Touch [Disc CTRL].

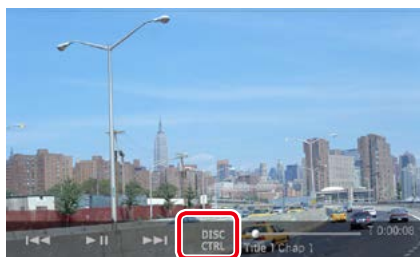

Zoom Control screen appears.

NOTE

- For DVD, please refer to [DVD Play Mode Setting \(P.68\)](#) to display the Zoom Control screen.

- 3 Perform desired operation as follows.



Switches zoom ratio

Touch [Zoom].

For DVD, changes the zoom ratio at 4 levels;
Off, 2 times, 3 times, 4 times.

For VCD, changes the zoom ratio at 2 levels;
Off, 2 times.

Scrolls the screen

Touch [▲], [▼], [◀], or [▶] to scroll the screen
in the direction you touch.

Exits menu control

Touch [Exit].

Displays the previous menu*

Touch [Return].

*** This function may not be performed
depending on the disc.**

NOTE

- You cannot touch the menu keys directly on the screen when zooming.

DVD Setup

You can set up the DVD playback functions.

- 1 Touch [].**
Quick menu appears.
- 2 Touch [SETUP].**
SETUP Menu screen appears.
- 3 Touch [Source].**



Source SETUP Menu screen appears.

- 4 Touch [DVD SETUP] in the list.**
DVD SETUP screen appears.

5 Set each item as follows.



Menu/Subtitle/Audio Language*

See [Language setup \(P.70\)](#).

Dynamic Range Control*

Set the dynamic range.

Wide: The dynamic range is wide.

Normal: The dynamic range is normal.

Dialog (Default): Makes the total sound volume larger than other modes. This is effective only when you are using Dolby Digital software.

Angle Mark

Set an angle mark display.

ON (Default): An angle mark appears.

OFF: An angle mark does not appear.

Screen Ratio*

Set the screen display mode.

16:9 (Default): Displays wide pictures.

4:3 LB: Displays wide pictures in the Letter Box format (having black stripes at the top and bottom of screen).

4:3 PS: Displays wide pictures in the Pan & Scan format (showing pictures cut at the right and left ends).

Continued

Parental Level*

See [Parental level \(P.71\)](#).

DISC SETUP

See [Disc setup \(P.71\)](#).

Stream Information

Displays the present source information.

The stream (Dolby Digital, Linear PCM, MPEG, WMA or AAC) appears.

*These items are disabled when a DVD is being played.

Language setup

This setting is for the language used in the menu, subtitle, and voice. You cannot setup these items during DVD playback.

1 Touch [SET] of the desired item; [Menu Language], [Subtitle Language], [Audio Language].

Language Set screen appears.

2 Enter the desired language code and touch [Enter].



For language code, refer to [DVD Language Codes \(P.158\)](#).

Sets the entered language and returns to the DVD SETUP screen.

NOTE

- To cancel the setup and return to the previous screen, touch [Cancel].
- To clear the entered code, touch [Clear].
- To set the DVD's original language for audio language, touch [Original].

Parental level

Set a parental lock level to prohibit children to watch video. You cannot set a parental lock level during DVD playback.

1 Touch [SET] of [Parental Level].
Parental Pass screen appears.

2 Enter the parental code and touch [Enter].
Parental Level screen appears.

NOTE

- To cancel the setup and return to the previous screen, touch [Cancel].
- To clear the entered code, touch [Clear].
- Current parental lock level appears as [Level#].

3 Touch [◀] or [▶] to select a parental lock level.

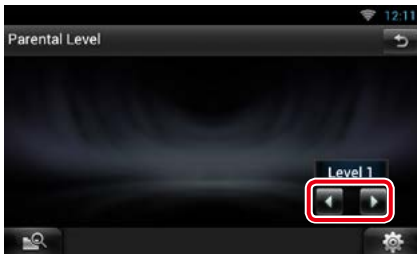

NOTE

- If a disc has higher parental lock level, you need to enter the code number.
- The parental lock level varies depending on a loaded disc.
- If a disc has no parental lock, anybody can play it even though you have set the parental lock.

Disc setup

Performs setup when using disc media.

1 Touch [SET] of [DISC SETUP].
DISC SETUP screen appears.

2 Select an option as follows.

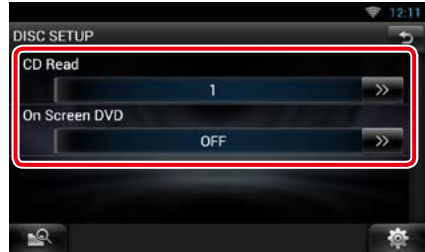

CD Read

Sets the motion of this unit when a music CD is played.

1 (Default): Automatically recognizes and plays an audio file disc, a DVD or a music CD.

2: Forcibly plays a disc as a music CD. Select [2] if you wish to play a music CD having a special format or if you cannot play a disc with the option [1] set.

On Screen DVD

Sets an on-screen display.

Auto: When updated, information appears for 5 seconds.

OFF (Default): Information does not appear.

NOTE

- [CD Read] is disabled when a disc is already in the unit.
- You cannot play an audio file/VCD disc with the option [2] set. Also, you may not play some music CDs with the option [2] set.

CD/Audio and Visual Files/iPod/Apps Operation

Music/Video Basic Operation

Most functions can be controlled from the source control screen and playback screen.

NOTE

• Set the remote controller mode switch to AUD mode before starting operation, see [Switching the operation mode \(P.145\)](#).

• To connect the Android device with this unit, the cable (sold separately) and the profile which your Android device supports are necessary as follows:

(A) To listen to music and watch video of APPS source

- MHL device
- KCA-MH100
- Bluetooth profile: SPP
- Application link setup: HDMI/MHL + BT

(B) To listen to music of APPS source

- Bluetooth profile: A2DP
- Bluetooth profile: SPP
- Application link setup: Bluetooth

(C) To listen to music of Bluetooth Audio source [\(P.115\)](#)

- Bluetooth profile: A2DP
- Bluetooth profile: AVRCP

• To connect the iPod/iPhone with this unit, the cable, adapter (both sold separately), and the profile which your iPod/iPhone supports are necessary as follows:

(A) To listen music and watch video with Lightning connector device

- Lightning Digital AV Adapter
- KCA-HD100
- Lightning to USB Cable (accessory of the iPod/iPhone)
- Bluetooth profile: SPP
- iPod connection setup: HDMI + BT

(B) To listen music with Lightning connector device

- Lightning to USB Cable (accessory of the iPod/iPhone)
- iPod connection setup: USB 1Wire

(C) To listen music and watch video with 30-pin connector device (analog)

- KCA-iP202
- iPod connection setup: USB + AV-IN

(D) To listen music with 30-pin connector device

- KCA-iP102
- iPod connection setup: USB 1Wire

(E) To listen to music via Bluetooth

- Bluetooth profile: A2DP
- Bluetooth profile: SPP
- iPod connection setup: Bluetooth

(F) To listen to music of Bluetooth Audio source [\(P.115\)](#)

- Bluetooth profile: A2DP
- Bluetooth profile: AVRCP

• When connecting with Lightning Digital AV Adapter or Apple 30-pin Digital AV Adapter some applications can be controlled from this unit. The operable functions depend on the application.

• Do not leave the cable or the adapter made by other makers inside the car. It might lead the malfunction caused by heat.

• Some settings are necessary to meet the connected iPod/iPhone or Android device. See [iPod/iPhone connection setup \(P.85\)](#) or [Application link setup \(P.86\)](#).

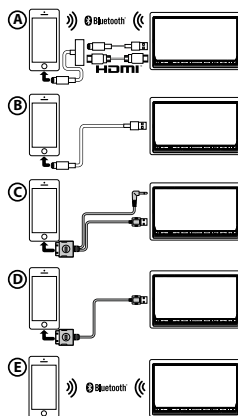
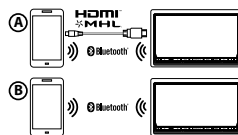

See the following sections for each source operation.

- Music CD ([P.73](#))
- USB device ([P.75](#))
- Apps ([P.83](#))
- Disc media ([P.73](#))
- SD Card ([P.75](#))
- iPod ([P.75](#))

Music CD and disc media

NOTE

- In this manual, "Music CD" will be referred to as the general CDs which include music tracks in. "Disc media" will be referred to as CD/DVD disc which includes audio, picture or video files.
- The screen shot below is for CD. It may be different from the one for disc media.

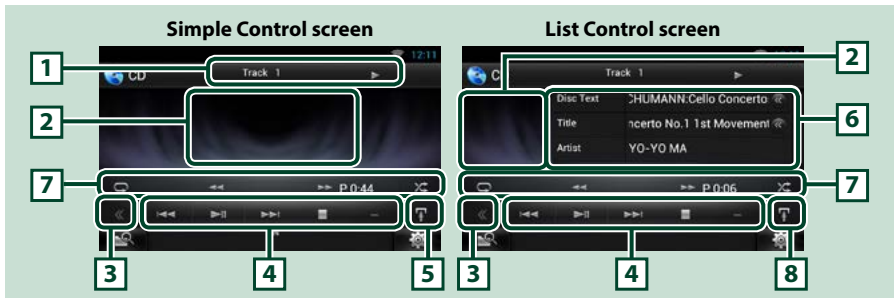

1 Information display

Displays the following information.

- Track #: Each time you touch this area, display switches between current track number, text, etc.
- ▶, ▶▶, ▶▶|, ■, etc.: Current play mode display
The meanings of each icon are as follows; ▶ (play), ▶▶ (fast forward), ◀◀ (fast backward), ▶▶| (search up), |◀◀ (search down), ■ (stop), ■R (resume stop), || (pause).

2 Movie display area/Control switching area

Touch to switch between the Simple Control and List Control screen. (Only for Music file)
Touch to display Video screen. (Only for Video file)

3 Multi function key

Touch to switch the multi function menu. For details on the menu, see [Multi function menu \(P.76\)](#).

4 Multi function menu

Various functions can be performed by using keys in this area. For details on the menu, see [Multi function menu \(P.76\)](#).

5 Sub function key

Touch to display "Sub function menu" (7 in this table).

6 Track information

Displays the information of the current track.

For music CD and disc media, you can switch the current track information and the current folder list by touching the list switching key (8 in this table).

Continued

7 Sub function menu

Various functions can be performed by using keys in this area. For details on the keys, see [Sub function menu \(P.77\)](#).

8 Sub function/ List switching key

Touch to display "Sub function menu" (7 in this table).

Touch and hold to switch between the track list and the ID3 tag information (disc media only).

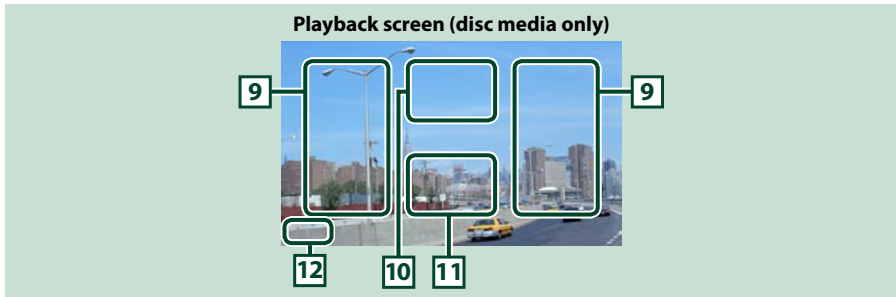

9 Searching file area (disc media only)

Touch to search the next/previous file.

Scrolling from center of display to left or right performs fast backward or fast forward. Each time you touch each area, the speed changes; standard, 2 times, 3 times. To stop fast backward/forward, touch center of the display.

10 Menu display area (disc media only)

Touch to display the Control screen. For details, see [Movie Control \(P.82\)](#).

11 Key display area (disc media only)

Touch to display the last control screen.

12 Screen setup display area

Touch and hold to display the screen control screen. See [Monitor Screen Setup \(P.124\)](#).

USB device, SD card and iPod

NOTE

- SD card is for DNN9250DAB and DNN6250DAB only.
- The screen shot below is for USB device. It may be different from the one for iPod and SD card.

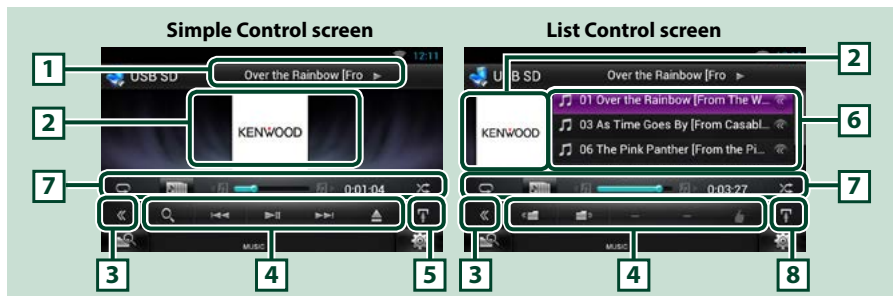

1 Information display

Displays the following information.

- **Current file name:** Each time you touch this area, display switches between file number/folder number and file name.
- **▶, ▶▶, etc.:** Current play mode display
The meanings of each icon are as follows; ▶ (play, searching), || (pause), ▶▶ (forward manual search), ◀◀ (reverse manual search).

2 Artwork/Control switching area

Touch to switch between the Simple Control and List Control screen. (Only for Music file)

Touch to display Video screen. (Only for Video file)

3 Multi function key

Touch to switch the multi function menu. For details on the menu, see [Multi function menu \(P.76\)](#).

4 Multi function menu

Various functions can be performed by using keys in this area. For details on the keys, see [Multi function menu \(P.76\)](#).

5 Sub function key

Touch to display "Sub function menu" (7 in this table).

6 Content list

Displays the list and content. The content of the list differ depending on the playback status and source.

When you select the video source on the device connected with the Lightning connector, the source is switched to Apps ([P.83](#)) automatically.

7 Sub function menu

Various functions can be performed by using keys in this area. For details on the keys, see [Sub function menu \(P.77\)](#).

8 Sub function/ List switching key

Touch to display "Sub function menu" (7 in this table).

Touch and hold to switch between the file list and the current file information.

Continued

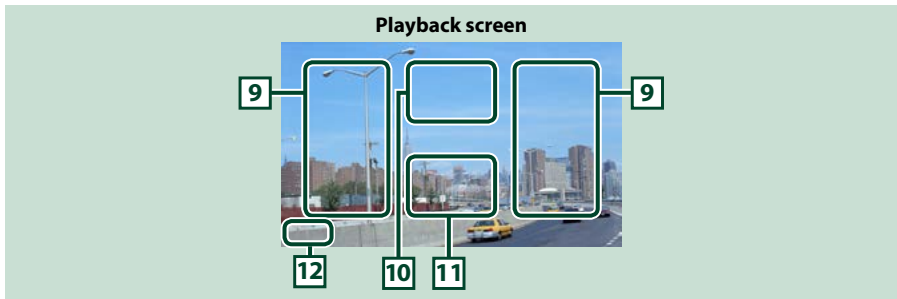

9 Searching file area (Video file only)

- Touch to search the next/previous file.
- During slide show in USB mode, touching each area searches the next/previous music file.
- Scrolling from center of display to left or right performs fast backward or fast forward. To stop fast backward/forward, touch center of the display. This function is not available when there is no music file in the current folder.

10 Movie control display area

Touch to display the Movie control screen. For details, see [Movie Control \(P.82\)](#).

11 Key display area (Video file only)

Touch to display the last control screen.

12 Screen setup display area

Touch and hold to display the screen control screen. See [Monitor Screen Setup \(P.124\)](#).

Multi function menu

Music CD



iPod



Disc media



USB device and SD card



The following functions can be performed by using keys in this area.

[🔍] (Only for disc media, iPod, USB device, and SD card)

Searches track/file. For details on search operation, see [Search Operation \(P.78\)](#).

[⏪] [⏩]

Searches the previous/next track/file.

[▶ ||]

Plays or pauses.

[■] (Only for music CD and disc media)

Stops playback.

[⏏] (Only for iPod, USB device, and SD card)

Touch to disconnect the device. For details, see [How to Play Media \(P.20\)](#).

[<] [>] (Only for disc media, USB device, and SD card)

Searches previous/next folder.

[♡] (Like) (Audio file only)

Saves the artist name and the title by pressing it while your favorite song is being played. After saving, you can search for the song and play it from the list of the Summary Board using YouTube. See [Summary Board Widget \(P.60\)](#).

Sub function menu

Music CD



Disc media



iPod



USB device and SD card



The following functions can be performed by using keys in this area.

[⏮]

Repeats the current track/folder. Each time you touch the key, repeat mode switches in the following sequence;

CD: "track repeat" "repeat off"

iPod: "song repeat" "all songs repeat" "repeat off"

Disc media, USB device, SD card: "file repeat" "folder repeat" "repeat off"

[🎵] (Only for iPod, USB device, and SD card)

Searches track from the album artwork list. For details on search operation, see [Search from album artwork \(P.80\)](#).

[⏩] [⏪] (Only for music CD and disc media)

Fast forward or fast backward.

[⏮] [⏭] (Only for iPod, USB device, and SD card)

Plays the previous or next album in [Favorite list \(P.81\)](#).

#:##:## or ##:##

For confirmation of play time.

During music CD playback, you can also confirm disc remaining time by touching time display. Each time you touch, the display switches between "P #:##:##" (track play time display) and "R #:##:##" (disc remaining time).

[⏸]

Randomly plays all tracks in current folder/disc or in current playlist in the connected iPod.

Each time you touch the key, random mode switches in the following sequence;

CD: "track random" "random off"

Disc media, USB device, SD card: "file random" "random off"

iPod: "track random" "album random" "random off"

Status bar in center (Only for iPod, USB device, and SD card)

For confirmation of current playing position.

During USB device and iPod playback, you can drag the circle left or right to change the playing position.

Search Operation

You can search music or video files by the following operations.

NOTE

- If you use a remote controller, you can jump directly to the desired track/file with entering the track/folder/file number, play time, etc. For details, see [Direct search mode \(P.145\)](#).

List search

You can search tracks, folders, and files according to hierarchy.

1 Touch illustrated area.

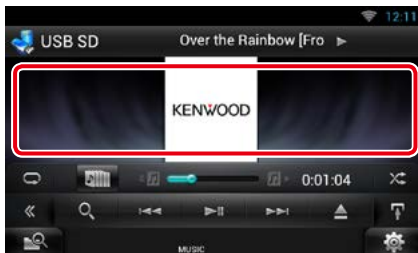

List Control screen appears.

2 Touch desired track/file.

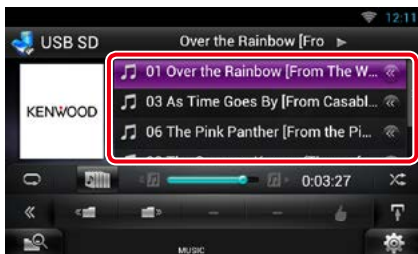

Playback starts.

NOTE

- For disc media, you can switch the file list and folder list by touching [Q].
- For disc media, you cannot display the list during random play and stop.

Other search

There are other search methods in order to narrow search for a song.

This function is not available when music CD is the current source.

1 Touch [Q] in the control screen.

The search type screen appears.

2 Touch desired search method.

USB device and SD card

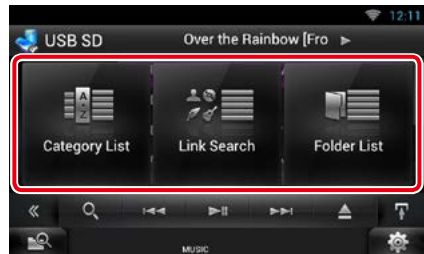

iPod

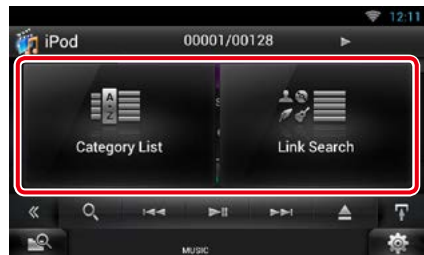

The list sorted in the way you selected appears.

See the following sections for each operation.

- [Category List]: You can search a file by selecting category ([P.79](#)).
- [Link Search]: You can search a file of same artist/album/genre/composer as the current track ([P.79](#)).
- [Folder List]: You can search a file according to hierarchy ([P.80](#)).

NOTE

- For disc media, you can display the folder list directly by touching [Q].

Category search (Only for iPod, USB device, and SD card)

- 1 Touch the desired category from the left part of the screen.

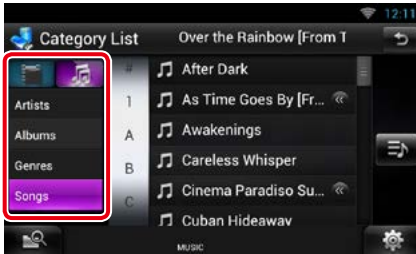

- 2 The list is sorted by selected category.
- 3 Touch desired song.
Playback starts.

NOTE

- To narrow the search you can select a letter from the alphabet list in the center of the display.
- For operations in the list screen, see [Common Operation \(P.27\)](#).

Link search (Only for iPod, USB device, and SD card)

- 1 Touch the desired link from the left part of the screen. You can select from artist, album, genre and composer.

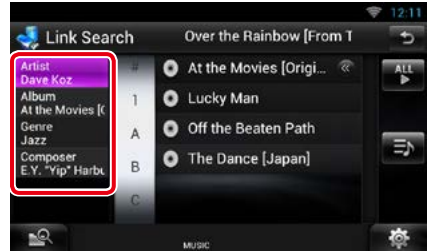

The link list corresponding to your selection appears.

NOTE

- The list is sorted by the way you selected.
 - Artist: Displays the album list of the artist.
 - Album: Displays all tunes of the current album.
 - Genre: Displays the artists list in which artists belong to the same genre.
 - Composer: Displays the album list of the composer of the current file.

- 2 Touch to select desired item in the list. Repeat this step until you find the desired file.

NOTE

- To narrow the search you can select a letter from the alphabet list in the center of the display.
- For operations in the list screen, see [Common Operation \(P.27\)](#).

Folder search (Only for disc media, USB device, and SD card)

1 Touch the desired folder.



Folders in the selected source are displayed in the center.

When you touch a folder its contents are displayed.

The hierarchy till the current folder is displayed on the left.

2 Touch desired item from the content list.

Playback starts.

NOTE

- For operations in the list screen, see [Common Operation \(P.27\)](#).

Search from album artwork (Only for iPod, USB device, and SD card)

You can search music files by selecting the album artwork.

1 Touch [].

Sub function menu appears.

2 Touch [].

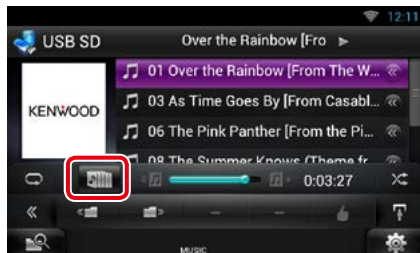

Favorite screen appears.

3 Touch desired artwork in the upper line.

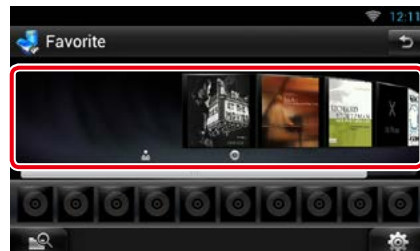

NOTE

- The key in the upper side of the screen functions differently depending on the status.
 - When [Load Albums] appears:
You have not yet loaded any artwork. Touch the key to start loading.
 - When [Load More Albums] appears:
Some artwork are not loaded. Touch the key to load all artwork. If you touch the key, the track being played may stop and another track may start playback.
 - When the key does not available:
All artwork are already loaded.

4 Touch [▶] on the selected artwork.

The first song in the album is played.
In addition, you can create your original playlist from this screen. For details, see [Favorite list \(P.81\)](#).

NOTE

- After all tracks in the album are played, the same album is played again from the first track.
- The albums with no photo are not displayed.

Favorite list

You can create an original playlist of your favorite 10 albums by selecting album artworks.

1 Touch and drag the desired album artwork in the upper line to the lower line.

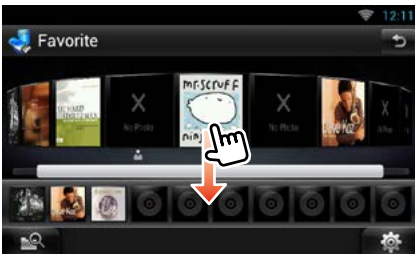

Selected album is registered to the favorite list.

NOTE

- The added album is placed on farthest right.
- You cannot register the same album already registered to the favorite list.
- Up to 10 albums can be registered to the list.

2 Touch the desired artwork in the favorite list.



The selected album is played and the control screen appears.

NOTE

- The favorite list is played to the right starting with the selected album.
- To delete the album from the favorite list, touch and drag it to the upper line.
- You can change the playing order of the favorite list by dragging the artwork in the list.
- The favorite list mode is canceled in the following situations.
 - Playing another album from other list (folder list, category list, etc.)
 - Playing another album by touching the artwork in the upper line in the artwork list screen.
- The favorite list mode resumes after disconnecting/connecting the device or turning on/off. File being played, playing time code, favorite list content, favorite list order, etc. resumes if file configuration of the device is not changed.

Movie Control

You can adjust the movie playback.

- 1 In the playback screen, touch illustrated area.**



Movie control screen appears.

- 2 Touch [Disc CTRL]. (Disc media only)**

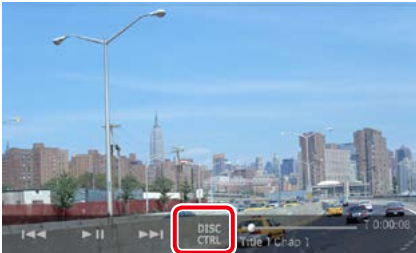

Movie Control screen appears.

- 3 Perform desired operation as follows.**



Changes subtitle language

Touch [Subtitle].

Changes audio language

Touch [Audio].

Exits the menu



Touch [Exit].

Apps Operation

You can listen to music or watch video from the Apps operating on iPod touch/iPhone or Android.

NOTE

- When you first select APPS as a source, the setting screen for the connection with the device installed the apps will appear. For the details, refer to [Application link setup \(P.86\)](#).

- Press the <HOME> button.
- Flick the screen left or right to select the Source launcher panel.
- Touch [].
- Touch [ APPS].

NOTE

- When you turn on the power and select apps as the source, the caution for the operation, watching video and listening music appears. With your acceptance, you can control apps, listen to music and watch video from apps when you are driving.



1 [▶] [II] (iPod only) / [II]

Plays or pauses.

2 [◀◀] [▶▶]

Searches the previous/next file.

Touch and hold to fast backward/ forward. (iPod/ iPhone only)

3 Key display area

Touch to display the operation buttons. Touch again to erase them.

NOTE

- The operable functions depend on the application.

USB/SD/iPod/DivX/Apps Setup

You can perform setup when using USB/SD/iPod/ DivX.

- 1 Touch [].
Quick menu appears.
- 2 Touch [SETUP].
SETUP Menu screen appears.
- 3 Touch [Source].



Source SETUP Menu screen appears.

- 4 Touch [USB SETUP], [iPod SETUP], [APPS SETUP] or [DivX VOD] in the list.
Each setup screen appears.
See the following section for each setting.

- [USB setup \(P.84\)](#)
- [iPod setup \(P.84\)](#)
- [Apps setup \(P.86\)](#)
- [DivX® VOD \(P.88\)](#)

USB setup

- 1 Set each item as follows.

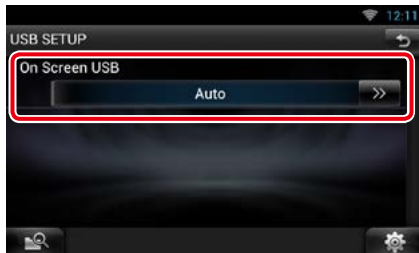

On Screen USB

Set how information from a USB device or SD is displayed.

Auto (Default): Information appears for 5 seconds when updated.

OFF: Does not display any information.

iPod setup

- 1 Set each item as follows.



AudioBook Speed

Set the audio book playback speed. Select from [Slow], [Normal] (default), and [Fast].

Wide Screen*1

Set Wide Screen. Set [ON] (default) or [OFF].

On Screen iPod

Set how to display the information of the iPod.

Auto (Default): Information appears for 5 seconds when updated.

OFF: Does not display any information.

iPod Connection Setup*2

Sets the way to connect the iPod/iPhone with this unit.

*1 This setting is not available when an iPod is connected.

*2 This item can be set when in STANDBY source.

iPod/iPhone connection setup

- 1 Press the <HOME> button twice to the Source launcher panel.
- 2 Touch [].
- 3 Touch [ STANDBY].
- 4 Touch [].
- 5 Touch [SETUP].
- 6 Touch [Source].
- 7 Touch [iPod SETUP].
- 8 Touch [iPod Connection Setup] in the iPod SETUP screen.
iPod connection setup screen appears.



9 Touch [CHANGE].

10 Set each item as follows.



USB + AV-IN

Select when connecting with KCA-iP202.

USB 1Wire

Select when connecting with KCA-iP102 or Lightning to USB Cable.

HDMI + BT

Select when connecting with KCA-HD100 and Lightning Digital AV Adapter.

Bluetooth

Select when connecting via Bluetooth only.

11 Touch [Next].

Confirmation screen appears.

12 Touch [Done].

13 Touch [↩].

NOTE

- For the details of the necessary cable and adapter to connect with iPod/iPhone, refer to [Music/Video Basic Operation \(P.72\)](#).
- When you select "HDMI + BT" or "Bluetooth" in step 10, Bluetooth device selection screen will appear. Select the iPod/iPhone to be connected.

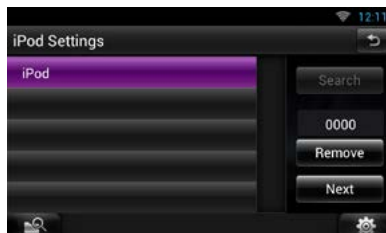

- If a connectable Bluetooth device is not displayed, touch [Search] and do the pairing of the devices.
- The setting of "iPod connection setup" is just for the unit and regardless of the account.

Apps setup

1 Set each item as follows.



APP Settings*

Makes the detailed setting of the device in which APPS are installed.

Screen Adjust

Touch [SET] to display the screen control screen. See [Monitor Screen Setup \(P.124\)](#).

APP interrupt volume (DNR8025BT)

Sets the volume level of the information from APP when it cuts in the music you are listening to.

* This item can be set when in STANDBY source.

Application link setup

1 Press the <HOME> button twice to the Source launcher panel.

2 Touch [].

3 Touch [STANDBY].

4 Touch [].

5 Touch [SETUP].

6 Touch [Source].

7 Touch [APPS SETUP].

8 Touch [SET] on [APP Settings] in the APPS SETUP screen.

Application link setup screen appears.



9 Touch [CHANGE].

10 Select the device installed the apps.

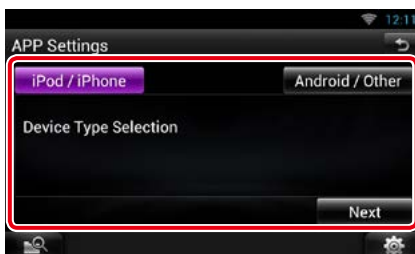

iPod/iPhone

Select when using iPod/iPhone.

Android/Other

Select when using Android or BlackBerry device.

11 Touch [Next].

12 Select the way to connect the device with this unit.

When selecting [iPod/iPhone]



USB + AV-IN

Select when connecting with KCA-iP202.

USB 1Wire

Select when connecting with KCA-iP102 or Lightning to USB Cable.

HDMI + BT

Select when connecting with KCA-HD100 and Lightning Digital AV Adapter.

Bluetooth

Select when connecting via Bluetooth only.

When selecting [Android/Other]

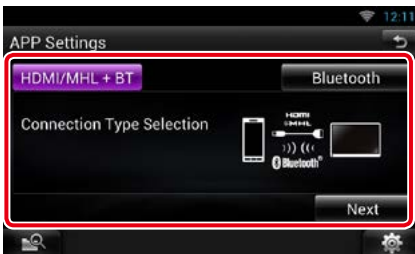

HDMI/MHL + BT

Select when connecting with KCA-MH100.

Bluetooth

Select when connecting via Bluetooth only.

13 Touch [Next].

Confirmation screen appears.

14 Touch [Done].

NOTE

- For the details of the necessary cable and adapter to connect with iPod/iPhone and Android device, refer to [Music/Video Basic Operation \(P.72\)](#).
- When you select "HDMI + BT"; "HDMI/MHL + BT" or "Bluetooth" in step 12, Bluetooth device selection screen will appear. Select the device to be connected.

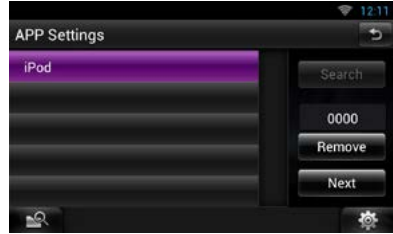

If a connectable Bluetooth device is not displayed, touch [Search] and do the pairing of the devices.

- When you select "iPod/iPhone" in Apps Setup, select "iPod" as the source, and select App on the iPod, the source of this unit is also changed to App automatically.
- The setting of "Application link setup" is just for the unit and regardless of the account.

DivX® VOD

1 Set each item as follows.

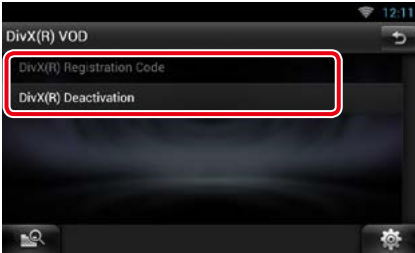

DivX(R) Registration Code

Checks the registration code. This code is needed when making a disc which has DRM (Digital Rights Management).

DivX(R) Deactivation

Deregisters the unit which is already registered. After you touch the key, a confirmation message appears. Follow the message and complete the operation.

NOTE

- [DivX(R) Registration Code] is disabled when a DVD is being played.
- When downloading a DivX VOD file controlled by DRM, register the code appeared on the screen. Otherwise the file may not be able to play with this unit. Remaining number of viewing is displayed when playing a DivX VOD file with the viewing restriction. When the remaining number of viewing reached 0, a warning message appears and the file cannot be played.

Cloud Storage Operation

Starting procedure

Make preparations for allowing this unit to play the music files uploaded to Dropbox.

Preparation

- You must have a connection with the internet using Wi-Fi. See [Wi-Fi Setup \(P.34\)](#).
- You can use a user account when you have logged in the Owner or User.
- To use this service, a Dropbox account is required.

1 Upload music files to Dropbox.

2 In the Route Collector site, create a folder and playlist of the files to be played.

For how to set the folder and playlist of the files to be played, refer to the website.

<http://www.route-collector.com/>

Available content

Content that can be delivered or played by this unit are as follows:

- Audio file: MP3 (.mp3), AAC-LC (.m4a/.aac), WMA (.wma), WAV (.wav), FLAC (.flac)
- Copyrighted content cannot be played.

Music Basic Operation

The music files uploaded to Dropbox can be played.

Preparation

- To play the files uploaded to Dropbox, setting is required. See [Starting procedure \(P.90\)](#).

1 Press the <HOME> button.

2 Flick the screen left or right to select the Source launcher panel.

3 Touch [].

4 Touch [Storage].



[▶||]

Plays or pauses.

[◀◀] [▶▶]

Searches the previous/next file.

[🔍]

Searches file. For details on search operation, see [Category search \(P.91\)](#).

[👍] (Like)

Saves the artist name and the title by pressing it while your favorite song is being played. After saving, you can search for the song and play it from the list of the Summary Board using YouTube. See [Summary Board Widget \(P.60\)](#).

[🔄]

The data base like the song information in the server is reorganized. Press it when you change the file in the Dropbox.



Touch to switch the multi function menu.



Touch to display "Sub function menu".

Touch and hold to switch between the file list and the current file information.



Repeats the current file. Each time you touch the key, repeat mode switches on or off.



Randomly plays all files in current folder or in current playlist.

Each time you touch the key, random mode switches in the following sequence; "file random"  "random off"

#:##:##

For confirmation of play time.

Status bar in center

For confirmation of current playing position.
You can drag the circle left or right to change the playing position.

Category search

You can search music files by the following operations.

1 Touch in the control screen.

The search type screen appears.

2 Touch the desired category from the left part of the screen.

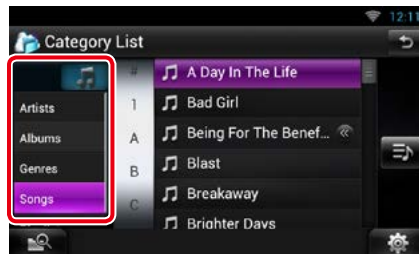

3 The list is sorted by selected category.

4 Touch desired music file.

Playback starts.

NOTE

- To narrow the search you can select a letter from the alphabet list in the center of the display.
- For operations in the list screen, see [Common Operation \(P.27\)](#).

Kenwood Wireless Link Operation

Starting procedure

By using the Wi-Fi function, media files can be shared with another media server device or client (player) device.

Preparation

- Turn on the function of Wi-Fi connection to a media server device or client device. See [Wi-Fi Setup \(P.34\)](#).

About Network connection

There are two types of network to connect to the media server device or the client (player) device.

- **Wi-Fi access:** The internet device that becomes the Wi-Fi access point is necessary. Smartphone and tablet PC can be connected through the Wi-Fi access point. See [Wi-Fi Setup \(P.34\)](#).
– You cannot listen to music or watch video in the smartphone when its tethering function is in use.

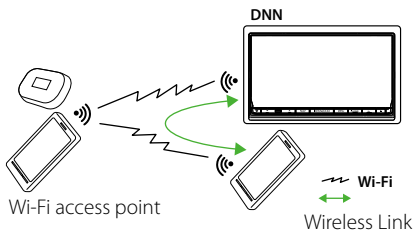

- **Wi-Fi hotspot:** This unit becomes the Wi-Fi access point and can connect with smartphone and tablet PC. See [Wi-Fi Hotspot Setup \(P.36\)](#).

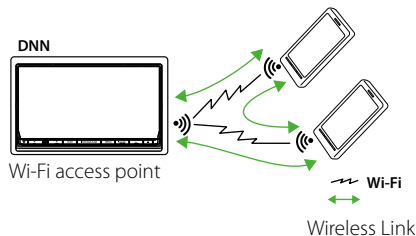

Media Server function

Plays the content stored in the USB memory or SD card connected to this unit via another network media player (client device).

- We confirmed normal operation using the following network media players (software):
- Windows Media Player 12

Media Player function

Plays the content stored in another media server device via this unit.

- We confirmed normal operation using the following media servers (software):
- Windows Media Player 12

Media Controller function

Allows you to handle the content stored in another media server device via this unit and play them on another network media player (client device).

Media Renderer function

Plays the content being operated on another media controller through this unit.



Available content

Content that can be delivered or played by this unit are as follows:

- Audio file: MP3 (.mp3), AAC-LC (.m4a/ .aac), WMA (.wma), WAV (.wav), FLAC (.flac)
- Video file: MPEG-1/2 (.mpg/ .mpeg/ .m2p), MPEG-4 (.mp4/ .m4v), WMV (.wmv/ .m2ts), MKV (.mkv)
- Copyrighted content cannot be played.

Media Server function

Plays the content stored in the USB memory or SD card connected to this unit via another network media player (client device).

- 1 Press the <HOME> button.
- 2 Flick the screen left or right to select the Source launcher panel.
- 3 Touch [].
- 4 Touch [ Wireless Link].
- 5 Touch [DMS].





The server function is turned on.

- 6 **Connect from the client device.**
Operate the client device to connect to the server.
Server name: DNN9250DAB, DNN6250DAB or DNR8025BT.

Media Player function

Plays the content stored in another media server device via this unit.

- 1 Press the <HOME> button.
- 2 Flick the screen left or right to select the Source launcher panel.
- 3 Touch [].
- 4 Touch [ Wireless Link].
- 5 Connect to the media server.

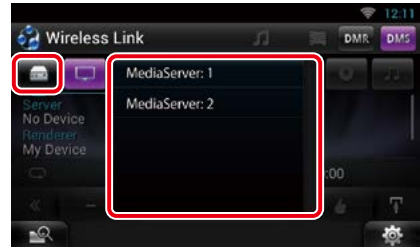

A list of detected media servers is displayed.

Touch the server name of the server to connect.

- 6 **Select the content to play.**



Select the category of the content to play.
A list of detected content is displayed.

Plays screen





Plays or pauses.



Searches the previous/next file.

 (Like) (music file only)

Saves the artist name and the title by pressing it while your favorite song is being played. After saving, you can search for the song and play it from the list of the Summary Board using YouTube. See [Summary Board Widget \(P.60\)](#).



Repeats the current file. Each time you touch the key, repeat mode switches on or off.



Switches between music and video files.

###:## or ##:##

For confirmation of play time.

Status bar in center



For confirmation of current playing position. You can drag the circle left or right to change the playing position.



Touch to display "Sub function menu". Touch and hold to switch between the file list and the current file information.

Media Controller function

Allows you to handle the content stored in another media server device via this unit and play them on another network media player (client device).

- 1 Press the **<HOME>** button.
- 2 Flick the screen left or right to select the **Source launcher panel**.
- 3 Touch .
- 4 Touch  **Wireless Link**.
- 5 **Connect to the media server.**



A list of detected media servers is displayed.

Touch the server name of the server to connect.

- 6 **Select a network media player to be used for playback.**

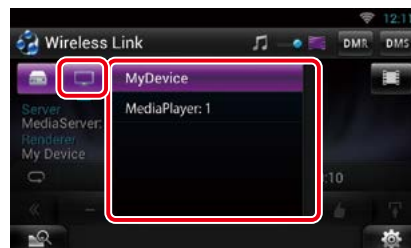



A list of detected network media players is displayed.

Touch the name of the network media player to be used for playback.

Media Renderer function

Plays the content being operated on another media controller through this unit.

- 1 Press the <HOME> button.**
- 2 Flick the screen left or right to select the Source launcher panel.**
- 3 Touch [].**
- 4 Touch [ Wireless Link].**
- 5 Touch [DMR].**



The Rendering function is turned on.

- 6 Establish connection from the media controller.**

Operate the media controller to connect to this unit.

This unit: DNN9250DAB, DNN6250DAB or DNR8025BT.

Radio and TV Tuner Operation

Radio Basic Operation

Most functions can be controlled from the source control screen.

NOTE

- Set the remote controller mode switch to AUD mode before starting operation, see [Switching the operation mode \(P.145\)](#).

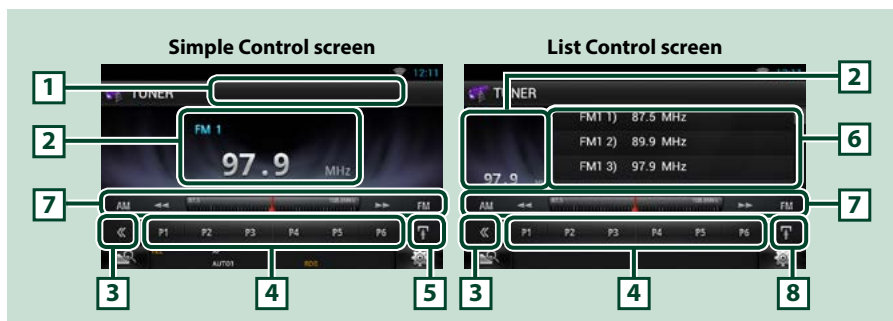

1 PS/Station name display

Displays the PS name.

2 Information display/Control switching area

Displays the following information.

- [FM1] etc.: Band display
- MHz/kHz: Frequency display
- Preset #: Preset number

Touch to switch between the Simple Control and List Control screen.

3 Multi function key

Touch to switch the multi function menu. For details on the menu, see [Multi function menu \(P.97\)](#).

4 Preset key/Multi function menu

Recalls the memorized station or channel. When touched for 2 seconds, stores the current receiving station or channel in memory.

When switched, various functions can be performed by using keys in this area.

For details on the menu, see [Multi function menu \(P.97\)](#).

5 Sub function key

Touch to display "Sub function menu" (7 in this table).

6 Preset list

Displays the list of preset stations and the information.

7 Sub function menu

The following functions can be performed by using keys in this area.

- **Switches the band:** Touch [AM] or [FM].
- **Tunes in a station:** Touch [◀◀] [▶▶]. The method of frequency switching can be changed. See Seek mode.
- The bar in center (tuner only) shows the current frequency location.

8 Sub function/ List switching key

Touch to display "Sub function menu" (7 in this table).

Touch and hold to switch between the preset list and the information list.

In tuner mode, tuned program information will be displayed.

Multi function menu



The functions of each key are as follows.

[P1] - [P6]

Select the preset station. Touch for 2 seconds to store the current station into the preset memory.

[Q]

Displays the list of preset stations or services. For details, see [Selecting Operation \(P.100\)](#).

[TI] (FM Tuner only)

Sets the traffic information mode on. For details, see [Traffic Information \(P.102\)](#).

[SEEK]

Switches the seek mode in the following sequence; [AUTO1], [AUTO2], [MANUAL].

- **AUTO1:** Tunes in a station with good reception automatically.
- **AUTO2:** Tunes in stations in memory one after another.
- **MANUAL:** Switches to the next frequency manually.

[AME]

Selects the auto memory mode. For details, see [Auto memory \(P.100\)](#).

[PTY] (FM Tuner only)

Searches a program by setting program type. For details, see [Search by program type \(P.101\)](#).

[MONO] (FM Tuner only)

Select the Monaural reception.

[LO.S] (FM Tuner only)

Turns the Local Seek function on or off.

Digital Radio Basic Operation (DNN9250DAB/ DNN6250DAB)

Most functions can be controlled from the source control screen.

NOTE

- Set the remote controller mode switch to AUD mode before starting operation, see [Switching the operation mode \(P.145\)](#).

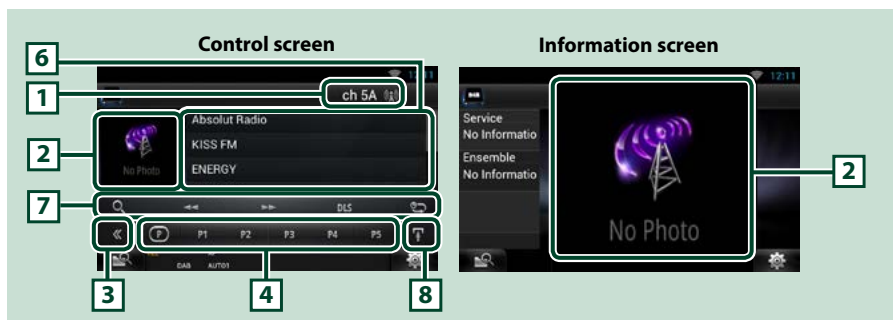

1 Signal Strength indication/Channel display

Displays the received signal strength of the Digital Radio station.

Displays the received channel number display.

2 Artwork/Control switching area

The picture data is displayed if available from current content.

Touch to switch between the Control and Information screen.

3 Multi function key

Touch to switch the multi function menu. For details on the menu, see [Multi function menu \(P.99\)](#).

4 Preset key/Multi function menu

Recalls the memorized station or channel. When touched for 2 seconds, stores the current receiving station or channel in memory.

When switched, various functions can be performed by using keys in this area.

For details on the menu, see [Multi function menu \(P.99\)](#).

5 Sub function key





Touch to display "Sub function menu" (7 in this table).

6 Information list

Displays information about the current music being played: Channel Name, Artist Name, Song Title, Content Info, Category Name, Channel Description, Similar Channels

7 Sub function menu

The following functions can be performed by using keys in this area.

- Display the list type screen: Touch []. See [Selecting Operation \(P.100\)](#).
- Tunes in a ensemble, service, and component:
Touch [] []. The method of ensemble, service, and component switching can be changed. See [Replay \(P.102\)](#).
- Display the Dynamic Label Segment screen: Touch [DLS].
- Change the Replay mode: Touch [].

8 Sub function/ List switching key

Touch to display "Sub function menu" (7 in this table).

Touch and hold to switch between the preset list and the information list.

Multi function menu



The functions of each key are as follows.

[]

Switches the preset number.

[P1] - [P5]/ [P6] - [P10]/ [P11] - [P15]

Select the preset channel. Touch for 2 seconds to store the current station into the preset memory.

[SEEK]

Switches the seek mode in the following sequence; [AUTO1], [AUTO2], [MANUAL].

- AUTO1: Tunes in a ensemble with good reception automatically.
- AUTO2: Tunes in ensemble in memory one after another.
- MANUAL: Switches to the next ensemble manually.

[TI]

Sets the traffic information mode on. For details, see [Traffic Information \(P.102\)](#).

[PTY]

Searches a program by setting program type. For details, see [Search by program type \(P.101\)](#).

[] (Like)

Saves the artist name and the title by pressing it while your favorite song is being played. After saving, you can search for the song and play it from the list of the Summary Board using YouTube. See [Summary Board Widget \(P.60\)](#).

Memory Operation

Auto memory

You can automatically store stations with good reception to memory.

This function is for radio only.

NOTE

- Auto memory terminates when 6 stations are stored or when all stations are tuned in.
- Auto memory ends automatically if you do not operate within 10 seconds.

1 Touch [].

Sub function menu appears.

2 Touch desired band key.



3 Touch [] in the control screen.

The multi function menu appears.

4 Touch [AME] in the multi function menu.

5 Touch [] or [] in the sub function menu.

Auto memory starts.

Manual memory

You can store the current receiving station or channel in memory.

1 Select a station or channel you wish to store in memory.

2 Touch [P#] (#:1-6, 1-15) in which you want to store the station for 2 seconds until a beep sounds.

Selecting Operation

Preset select

You can list and select memorized station or channel.

Selecting from the multi function menu

1 Touch the desired number from P1 to P6/ P15.

The unit will tune to the selected station or channel.

Selecting from the preset list

1 Touch illustrated area.



List Control screen appears.

2 Touch and hold [].

Preset list appears.

3 Select a station or channel from the list.



NOTE

- Touching [] and then [Preset List] displays the preset channel list. You can also select your desired channel from the list.

Search by program type

You can tune to a station with a specific program type when listening to FM or DAB.



- 1 Touch [] in the control screen.**
The multi function menu appears.
- 2 Touch [PTY] in the multi function menu.**
PTY Mode screen appears.
- 3 Select a program type from the list.**
- 4 Touch [Search].**



You can search a station of the selected program type.

List select

You can select an ensemble from a list of memorized ensembles or select a service from a list of all services received.

- 1 Touch [] in the control screen.**
The multi function menu appears.
- 2 Touch [] in the multi function menu.**
The list type screen appears.
- 3 Touch [Preset List] or [Service List].**



List screen appears.

- 4 Select the desired content from the list.**

Traffic Information

You can listen and watch the traffic information automatically when a traffic bulletin starts.

However, this feature requires a Radio Broadcast Data System that includes the TI information.

1 Touch [] in the control screen.

The multi function menu appears.

2 Touch [TI] in the multi function menu.

Traffic information mode is set.

When the traffic bulletin starts

The Traffic Information screen appears automatically.

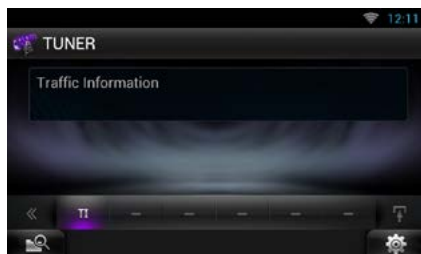

NOTE

- It is necessary to have Traffic Information function set to on in order to have the Traffic Information screen appear automatically.
- The volume setting during reception of traffic information is automatically stored. The next time the traffic information is received, this unit recalls the volume setting automatically.

Replay (Digital Radio only)

You can replay the last 30 minutes of current station.

1 Touch [] in the sub function menu.

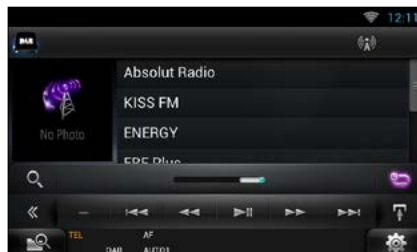

Multi function menu

[]

Plays or pauses.

[] []

Forward/backward 15 seconds when touch it.

[] []

Fast forward/fast backward when keep on touching.

Sub function menu

Replay time bar

Confirms the current location.

[]

Change the Live mode

NOTE

- PTY Watch starts operating and Replay function cannot be used while receiving a program.
- While replaying the current station, you can not store the station by [Auto memory \(P.100\)](#) and [Manual memory \(P.100\)](#).

Tuner Setup

You can set tuner related parameters.

1 Touch [].

Quick menu appears.

2 Touch [SETUP].

SETUP Menu screen appears.

3 Touch [Source].



Source SETUP Menu screen appears.

4 Touch [TUNER SETUP] in the list.

TUNER SETUP screen appears.

5 Set each item as follows.



NEWS

Sets a news bulletin interrupt time. Default is "OFF".

AF

When station reception is poor, automatically switches to the station that is broadcasting the same program over the same Radio Data System network. Default is "ON".

Regional

Sets whether to switch to the station only in the specific region using the "AF" control. Default is "ON".

Auto TP Seek

When traffic information station reception is poor, automatically searches for a station that can be received better. Default is "ON".

Language Select

Selects a display language for the PTY function.

DAB Setup (DNN9250DAB/ DNN6250DAB)

You can set Digital Radio related parameters.

1 Touch [].

Quick menu appears.

2 Touch [SETUP].

SETUP Menu screen appears.

3 Touch [Source].



Source SETUP Menu screen appears.

4 Touch [DAB SETUP] in the list.

DAB SETUP screen appears.

5 Set each item as follows.



Priority

If the same service is provided by Digital Radio during Radio Data System reception, automatically switches to Digital Radio. If the same service is provided by Radio Data System when reception of the service being provided by Digital Radio becomes poor, automatically switches to Radio Data System.

PTY Watch

If the service of the set program type begins with the ensemble being received, switches from any source to Digital Radio for service reception.

Announcement Select

Switches to the set Announcement service. For details, see [Announcement setup \(P.105\)](#).

Seamless Band

Prevents audio break when switching from Digital Radio to Analog Radio. Default is "ON".

Antenna Power*

Sets power supply to the Digital Radio antenna. Set to "ON" when the Digital Radio antenna in use is equipped with a booster. Default is "ON".

L-Band Tuning*

Sets L-band reception. When set to "ON", also receives L-band ensembles.

*** This item can be set when in STANDBY source.**

Announcement setup

When the service for which ON is selected starts, switches from any source to Announcement to receive it.

1 Touch [SET] of [Announcement Select] in the DAB SETUP screen.

The Announcement Select screen appears.

2 Touch each Announcement list and set on or off.

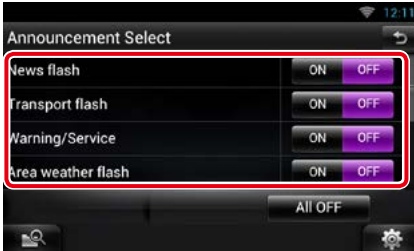

NOTE

- The volume setting during reception of Announcement service is automatically stored. The next time the Announcement service is received, this unit recalls the volume setting automatically.

TV Tuner Operation

You can connect the TV tuner (commercially available) with this unit and watch TV.

Before use

- When you use TV control function, connect the TV tuner (commercially available) and set 3rd Party TV Tuner Control in [AV Input Setup \(P.133\)](#) to ON.
- For TV tuner which uses TV control function, connect the video/audio cable to AV-IN terminal and the control cable to REMOTO OUT terminal.
- The TV tuner can be controlled with its supplied remote control through the remote sensor on the front panel of this unit.

Control screen



1

1 Control switching area

Touch to display TV screen.

TV screen



2 Switching channel area

Touch to switch the channel.

3 Menu display area

Touch to display the Menu control screen.

4 Key display area

Touch to display the control screen.

5 Screen setup display area

Touch and hold to display the screen control screen. See [Monitor Screen Setup \(P.124\)](#).

Menu Operation

1 Touch illustrated area during playback.



Menu Control screen appears.

2 Perform desired operation as follows.

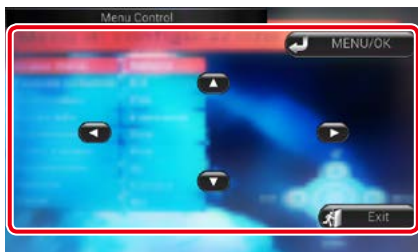

Displays the menu/ Enters selected item

Touch [MENU/OK].

Moves the cursor

Touch [▲], [▼], [◀], [▶].

Exits menu control

Touch [Exit].

Streaming Service Application

Streaming Video Application

You can play videos uploaded to YouTube.

Preparation

- You need to connect to Internet using Wi-Fi. See [Wi-Fi Setup \(P.34\)](#).

- 1 Press the <HOME> button.
- 2 Flick the screen left or right to select the Network contents panel.
- 3 Touch [].
- 4 Touch [ Streaming Video].

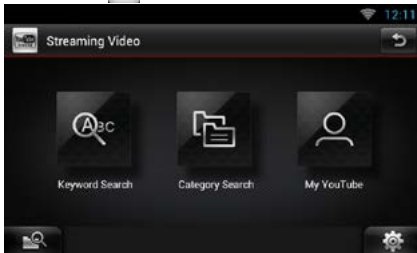

[Keyword Search]

Searches for videos associated by the keyword.

[Category Search]

Searches for videos by the category.

[My YouTube]

When you log in to YouTube, you can use the following:

Favorite Videos, Playlists, Recommends, Upload Lists, Channel Feed

Note

- The video playback which uses the internet browser is not guaranteed.

Keyword Search

- 1 Touch [Keyword Search].
- 2 Perform desired operation as follows.

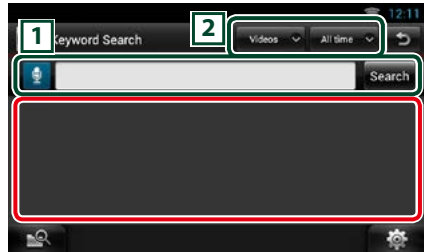

1

Enter a Keyword for search.

 : Enter a keyword using the voice recognition function. When "Speak now" is displayed, pronounce the keyword.

[Search] : Begins search.

2

Specify the search range.

Video screen

- 1 In the playback screen, touch illustrated area.



Control screen appears.

- 2 Perform desired operation as follows.



[<<<|>>>]

Searches the previous/next file.

[▶||]

Plays or pauses.

Status bar

For confirmation of current playing position.
You can drag the circle left or right to change the playing position.

My YouTube

By logging into YouTube, you can use My Favorites and My-Videos.

- 1 Press the <MENU> button.
- 2 Touch [Sign in].
- 3 Enter the Email address and Password.

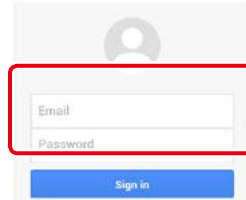

- 4 Touch [Sign in].
- 5 Touch [My YouTube].
- 6 Select a category.

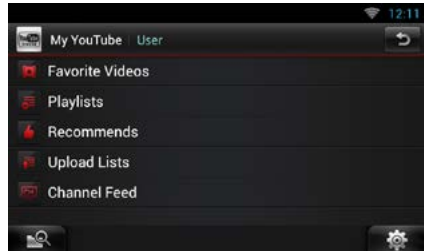

Menu

- 1 Press the <MENU> button.

[Sign in]

Log into the YouTube service.
Now you can use My YouTube.

[Sign out]



Logs out from the current account.

AUPEO! Application

You can listen to music on the online radio AUPEO!.

Preparation

- You need to connect to Internet using Wi-Fi. See [Wi-Fi Setup \(P.34\)](#).

- 1 Press the <HOME> button.
- 2 Flick the screen left or right to select the Network contents panel.
- 3 Touch [].
- 4 Touch [ Aupeo].
- 5 Select a genre.

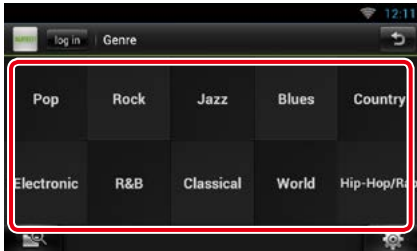

Log in

By registering an account, you can listen to your favorite songs.

- 1 Touch [log in].
- 2 Enter the User Name and Password.



- 3 Touch [log in].

Play screen

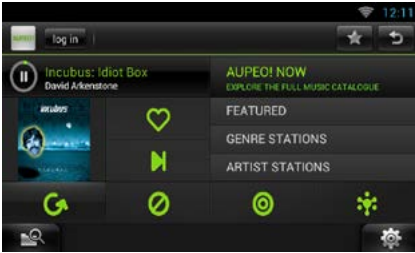

Plays or pauses.



I like this song.

Saves the artist name and the title by pressing it while your favorite song is being played. After saving, you can search for the song and play it from the list of the Summary Board using YouTube. See [Summary Board Widget \(P.60\)](#).



Play the next song.



I do not like this song.



Select a sub genre.

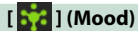

Music matching your mood.



Select a new genre.



Select a Featured Stations



Select a Genre Stations



Create a station of your type by searching stations by the artist name.

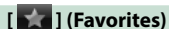

Edit the titles registered in Loves and Bans. You can use this button only when you have logged in to this service.

Editing Favorites

You can edit the titles registered in Loves and Bans.

Preparation

- You can only use this function when you have logged in this service.

1 Touch [★].



Switches between Love and Ban.



Deletes this title.



Registers this artist as Ban.

Bluetooth Control

Using the Bluetooth function, various functions can be used: listening to the audio file, making/receiving a call.

About the Smartphone/cell-phone and Bluetooth audio player

This unit conforms to the following Bluetooth specifications:

Version

Bluetooth Ver. 3.0+EDR Certified

Profile

Smartphone/cell-phone:

HFP (V1.6) (Hands Free Profile)

SPP (Serial Port Profile)

SDP (Service Discovery Profile)

PBAP (Phonebook Access Profile)

GAP (Generic Access Profile)

Audio player:

A2DP (Advanced Audio Distribution Profile)

AVRCP (Audio/Video Remote Control Profile)

Sound codec

DNN9250DAB : aptX, MP3, AAC, SBC

DNN6250DAB/ DNR8025BT : MP3, AAC, SBC

NOTE

- For the smartphones/cell-phones verified for compatibility, access the following URL:
<http://www.kenwood.com/cs/ce/bt/>.
- The units supporting the Bluetooth function have been certified for conformity with the Bluetooth Standard following the procedure prescribed by Bluetooth SIG.
However, it may be impossible for such units to communicate with your smartphone/cell-phone depending on its type.



Registering and Connecting Bluetooth Unit

It is necessary to register the Bluetooth audio player or smartphone/cell-phone to this unit before using the Bluetooth function.

You can register up to 5 Bluetooth units.

1 Press and hold the < > button.

DNN9250DAB/ DNR8025BT



DNN6250DAB

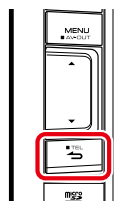

Hands Free screen appears.

2 Touch [].

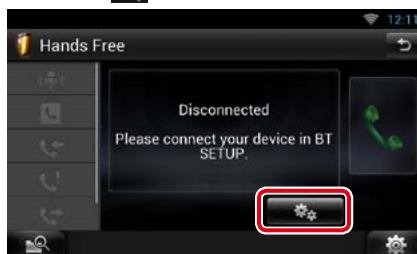

Bluetooth SETUP screen appears.

See the following section for each setting.

- **Registering the Bluetooth Unit** ([P.113](#))
- **Connecting the Bluetooth unit** ([P.113](#))
- **Registering from the Bluetooth unit** ([P.114](#))
- **Change the PIN code** ([P.114](#))

Registering the Bluetooth Unit

Preparation

- You cannot register the Bluetooth unit when you are using the following sources:
iPod, Bluetooth Audio, APPS
- If you want to register the Bluetooth unit while using one of the above mentioned sources, send the connection request from the Bluetooth unit and register it.

1 Touch [Search].

Searched Device List screen appears.

NOTE

- A new device cannot be registered if there are 5 registered Bluetooth units. Delete unnecessary registration. See [Connecting the Bluetooth unit \(P.113\)](#).
- This unit is compatible with the Apple Easy Pairing function. When an iPod touch or iPhone is connected to this unit using Dock Connector to USB Cable, an authentication dialog appears. Performing operation for authentication on this unit or iOS smartphone registers the smartphone as a Bluetooth device.

2 Select the Bluetooth unit to register from the list.



NOTE

- If the Bluetooth unit cannot be searched in step 1, you can search it again by touching [Search] in above screen.
- Touch [Cancel] to cancel searching for the Bluetooth unit.

3 Enter PIN code form the cell-phone.

Connecting the Bluetooth unit

1 Touch the name of device to connect.

Profile select screen appears.

NOTE

- If the icon is lighted, it means that the unit will use that device.

2 Set each profile as follows.



TEL (HFP)

Means that the Bluetooth unit is a smartphone/cell-phone.

Audio (A2DP)

Means that the Bluetooth unit is an audio player or smartphone/cell-phone with audio player.

NOTE

- If a device has been paired, the Bluetooth unit cannot be connected from the paired device.
- Touching [Remove] of [Device Remove Confirm] removes registration information. After you touch the key, a confirmation message appears. Follow the message and complete the operation.

■ Registering from the Bluetooth unit

- 1 Search the unit (“DNN****”) from your smartphone/cell-phone.
- 2 Input the PIN code in your smartphone/cell-phone.
PIN code is set to “0000” as the default.

SSP (Secure Simple Pairing of Bluetooth 2.1 or later)

- 1 Search the unit (“DNN****”) from your smartphone/cell-phone.
- 2 Confirm the request both on the smartphone/cell-phone and the unit.

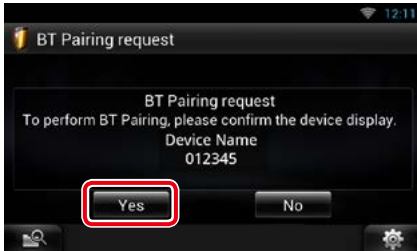

■ Change the PIN code

- 1 Touch [PIN Code Set].

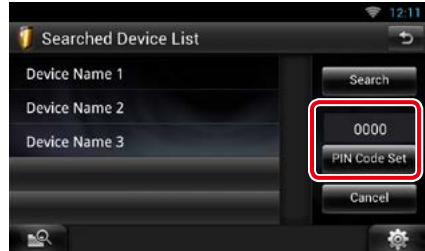

PIN Code Set screen appears.

- 2 Input the PIN code



- 3 Touch [Enter].

Playing Bluetooth Audio Device

Bluetooth basic operation

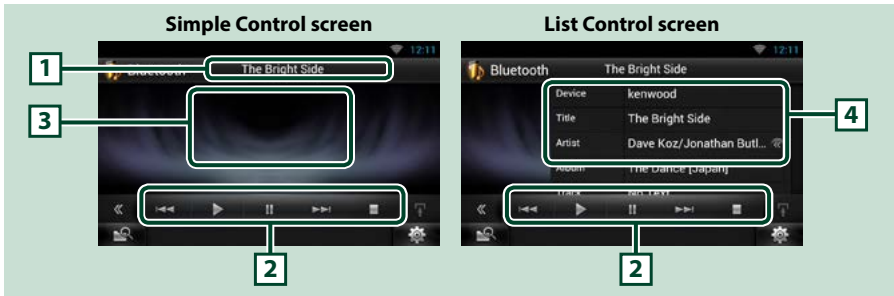

1 Information display

Displays the name of the content information. If the information is not available, Bluetooth unit name is displayed.

2 Multi function menu

The functions of each key are as follows.

- [◀◀] [▶▶]: Searches the previous/next content.*
- [▶]: Plays.*
- [⏸]: Pauses.*
- [■]: Stops playback.*

3 Control switching area

Touch to switch between the Simple Control and List Control screen.

4 Content information

Displays the information of the current content.

***These items appear only when the audio player which supports AVRCP profile is connected.**

NOTE

- If the operation keys do not appear, operate from the player.
- Depending on your smartphone/cell-phone or audio player, audio may be heard and controlled but text information may not appear.
- If the volume is too low, raise it on your smartphone/cell-phone or audio player.

Using Hands-Free Feature

You can make or answer a call with Hand-Free by connecting a smartphone/cell-phone with built-in Bluetooth connected to this unit.

Making a call

1 Press and hold the < > button.

DNN9250DAB/ DNR8025BT



DNN6250DAB

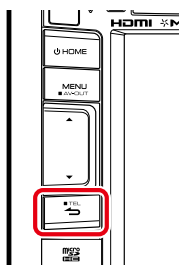

Hands Free screen appears.

NOTE

- If your cell-phone supports auto-download of phonebook but not downloaded automatically, follow the procedure above to download manually.
- See the instruction manual of your cell-phone for the operation.
- Up to 600 phone numbers can be registered for each registered cell-phone.
- Up to 32 digits can be registered for each phone number along with up to 50 characters representing a name. (50 is the number of alphabetical characters. Fewer characters can be input depending on the type of characters.)
- Depending on the type of your cell-phone, the following restrictions are placed;
 - The phonebook data cannot be downloaded normally.
 - Characters in the phonebook are garbled.
- To cancel downloading the phonebook data, operate the cell-phone.

2 Select a dialing method.



See the following table for each method.

Call by entering a phone number

- ① Touch [].
- ② Enter a phone number with number keys.
- ③ Touch [].

Call using call records

- ① Touch [] (Incoming Calls), [] (Outgoing Calls), or [] (Missed Calls).
- ② Select the phone number from the list.
- ③ Touch [].

Call using the phonebook

- ① Touch [].
- ② Select the name from the list.*1*2
- ③ Select the number from the list.
- ④ Touch [].

Call using the preset number

- ① Touch [Preset #] to start calling the corresponding phone number.

Voice Recognition

You can access the voice recognition function of the smartphone/cell-phone connected to this unit.

You can search a phone number in the smartphone/cell-phone phonebook by pronouncing a name. (The functionality depends on the cell-phone.)

- ① Touch [] to Voice Recognition screen appears.
- ② Pronounce a name.

*1 You can sort the list to begin with touched character.

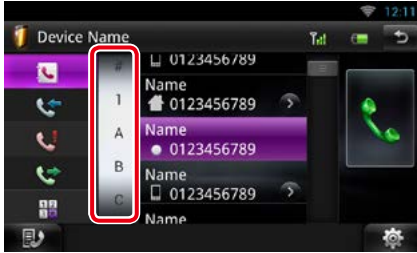

- Characters with no corresponding name will not appear.
- During search, a non-accent character such as “u” is searched for instead of an accent character such as “ü”.

*2 You can set the list to arrange in the order of last name or first name. For details, see [Hands-Free Setup \(P.120\)](#).

NOTE

- If you edited the phonebook in your cell-phone, touch “Download” on top of the phonebook list in this unit to download it from your cell-phone. The phonebook in this unit will be updated with the latest downloaded data.
- While your car is moving, some functions are disabled for safety reasons. The keys associated with the disabled functions become ineffective if touched.
- The status icons such as battery and antenna displayed may differ from those displayed on the cell-phone.
- Setting the cell-phone in the private mode can disable the hands-free function.

Voice Recognition

You can access the voice recognition function of the smartphone/cell-phone connected to this unit.

You can search a phone number in the smartphone/cell-phone phonebook by pronouncing a name. (The functionality depends on the cell-phone.)

1 Press the <MENU> button.

NOTE

- This function is not displayed in the menu when you are operating an application. Press the <HOME> button to use this function.

2 Touch [Voice].

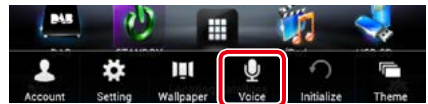

Voice Recognition screen appears.

3 Pronounce a name.

Phone number preset

You can register frequently used phone numbers to this unit.

1 Enter the number you want to register in Hands Free screen.



2 Touch [Preset 1], [Preset 2], or [Preset 3] for 2 seconds in the Hands Free screen.

Answering a call

- 1 Touch [] to answer a call or [] to reject a call.



NOTE

- While monitoring the camera view, this screen does not appear even if a call comes in. To display this screen, press the <TEL> button or return the shift knob of car to the driver position.

Operation during a call

Adjust the receiver volume

Press the <▼> or <▲> button.

DNN9250DAB/ DNR8025BT

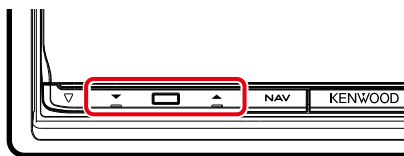

DNN6250DAB

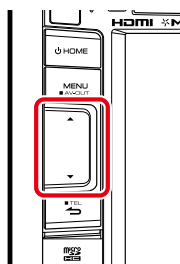

Switch the voice output

Touch [] / [] to switch the voice output between phone and speaker.

Sending DTMF tone signal

Touch [DTMF] to display the tone input screen. You can send tones by touching desired keys on the screen.

Call waiting

You can answer a second call while talking with the first caller by placing the first call on hold and switching to the second call. You can switch back and forth between first and second caller as well.

To answer the second call

Touch []. The first call is placed on hold and answers the second waiting call.

To switch back and forth between the first and second caller

Touch [] again.

Each time you touch [], the caller is switched.



To terminate the first call

Touch [].

The caller switches to the second caller.

Phone Number Search

You can search the address book in your cell phone for the number or the name, and make a call.

- 1 Touch [].
- 2 Select whether you search by Phonebook name  or Phone number  .
- 3 Enter the Phonebook name or Phone number.

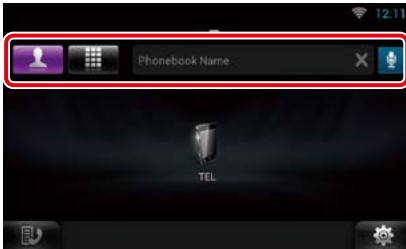

Enter the keyword using the voice recognition function. When "Speak now" is displayed, pronounce the keyword.

* You can use a user account when you have logged in the Owner or User.

- 4 Touch [TEL].

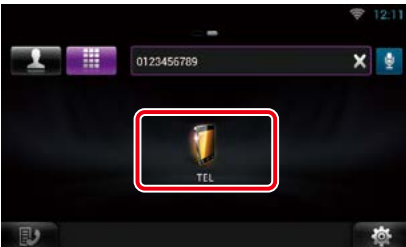

When searched by Phonebook name

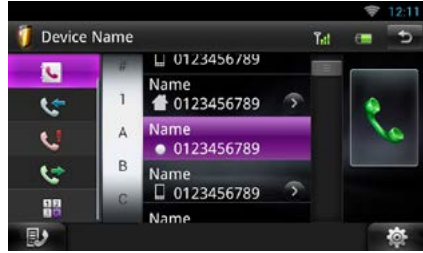

- 5 Touch [].

When searched by Phonebook number



The unit make a call.

Hands-Free Setup

You can perform various setup about hands-free function.

1 Touch [] on any screen.

2 Touch [SETUP].

SETUP Menu screen appears.

3 Touch [Bluetooth].



Bluetooth SETUP screen appears.

4 Touch [TEL SETUP].

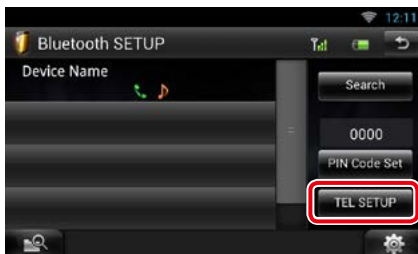

Hands-free SETUP screen appears.

5 Set each item as follows.

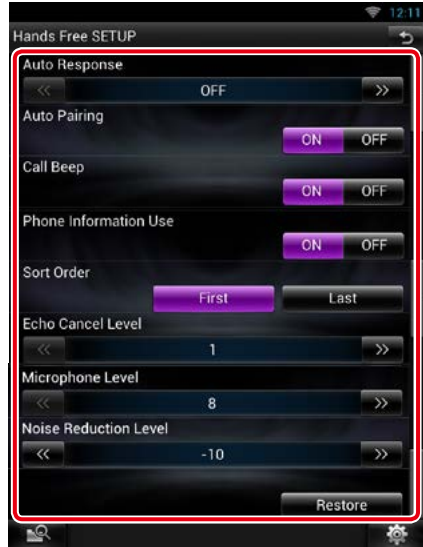

Auto Response*1

Select the ringing time interval until the system automatically answers a call.

OFF (Default): Automatic response is not available.

0-99: Set ringing time interval (second).

Auto Pairing

When set to "ON", the Apple Auto Pairing function is turned on to automatically register the iPod touch or iPhone connected to this unit.

ON (Default): Uses Apple Auto Pairing function.

OFF: Not uses Apple Auto Pairing function.

Call Beep

Select whether or not to beep upon receiving a call.

ON (Default): Beeps.

OFF: Not beeps.

Phone Information Use

Select whether to download phonebook for outgoing, incoming and missed calls list.

ON (Default): Yes.

OFF: No.

Sort Order

Set how to arrange the cell-phone phonebook.

First: Arranges in the order of first name.

Last (Default): Arranges in the order of last name.

Echo Cancel Level

Adjust the level of echo cancellation.

Default is "1".

Microphone Level

Adjust the sensitivity of the telephone microphone. Default is "3".

Noise Reduction Level

Reduces the noises generated by surrounding environment without changing the microphone volume. Use this setting when the voice of caller is not clear. Default is "-10".

[Restore]

Resets the settings to the default settings.

***1 Either the time interval for automatic answer set on this unit or the time interval set on your smartphone/cell-phone, whichever is shorter takes effect.**

Voice Control (DNN9250DAB)

The unit is equipped with Advanced Voice Recognition function which allows you to operate it with your voice. The supported languages are US English, UK English, French, German, Dutch, Italian, and Spanish. For information on the voice commands, refer to [<Voice command table> \(separate volume\)](#).

NOTE

- ASR on the Language Setting screen should be set to "Enabled". See [Language setup \(P.126\)](#).

Voice Control

- 1 Press the Push-To-Talk switch to enter the Voice control mode.**

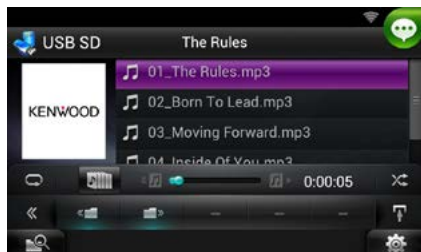

The buttons enclosed in a green square support the voice control.

- 2 Speak the command. (Ex: Speak "TUNER")**

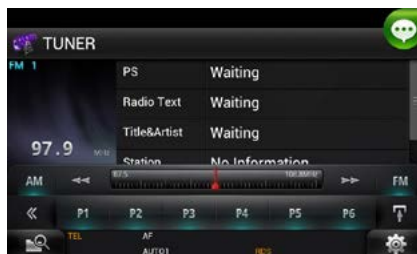

The screen has changed to the TUNER Control screen.

You will hear a beep again.

- 3 Repeat the same procedure as step 2.**

For information on the voice commands, refer to [<Voice command table> \(separate volume\)](#).

- 4 Press the Push-To-Talk switch to end the voice control mode.**

Displaying Voice Commands

To display the list of operable voice commands.

- 1 Press and hold the Push-To-Talk switch.**



The list of operable voice commands appears. Pronounce a command.

NOTE

- To cancel the commands list display, press Push-To-Talk switch or touch the screen.

Camera Control (DNN9250DAB/ DNR8025BT)

When a CMOS-3xx (optional accessory) is connected, the camera can be controlled from this unit.

Preparation

- [NAV/APPS Key Longer than 1 Second] must be set to "CAM". See [User interface \(P.125\)](#).

Camera Control

You can adjust the camera angle of the camera system and display of the guideline.

- 1 Press the <NAV>/ <APPS> button for 1 second.

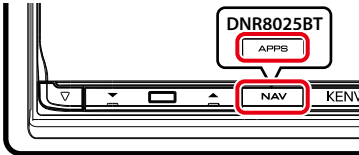

Camera view screen appears.

- 2 Adjust each item as follows.

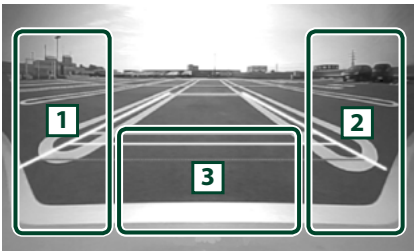

1 Guideline

Pressing each time turns on or off the guideline display alternately.

2 Angle

Pressing each time changes camera angles in the following order:

Super wide view/ Wide view/ Overhead view/
Wide view + Top view/ Corner view

3

Clearing the Camera View display.

Switching the View Camera

Switching between the front view camera and the rear view camera.

- 1 Press the <NAV>/ <APPS> button for 1 second.

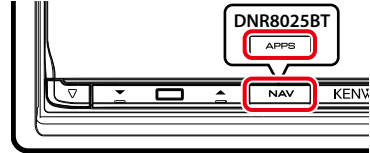

Camera view screen appears.

- 2 Touch illustrated area during Camera view screen.

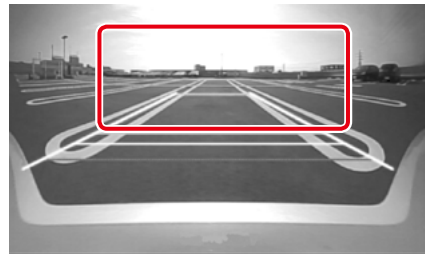

Switches between the front view camera and rear view camera each time you touch the illustrated area.

Setting Up

Monitor Screen Setup

You can adjust image quality of playback screen, background screen, etc.

1 Touch and hold the lower left area of any screen.

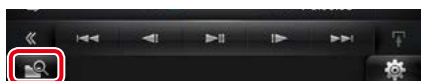

Screen Control screen appears.

2 Adjust each item as follows.



Background screen



Bright / Tint / Color / Contrast / Black / Sharpness

Adjusts each item.

Dimmer

Select dimmer mode.

ON: The display and buttons dim.

OFF: The display and buttons do not dim.

SYNC (Default): Turns the dimmer function on or off when the vehicle light control switch is turned on or off.

NAV-SYNC: Turns the dimmer function on or off according to the Navigation Day/Night display setting. (DNN9250DAB/ DNN6250DAB)

Mode (Playback screen only)

Select screen mode.

Full: Full picture mode

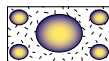

Just: Justify picture mode

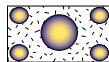

Zoom: Zoom picture mode

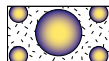

Normal: Normal picture mode

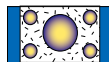

NOTE

- Adjusting items are different depending on the current source.
- You can perform this function only when you have applied the parking brake.
- The image quality can be set for each source.

System Setup

NOTE

- Each operation in this section can be started from the multi function menu.

- 1 Touch [] on any screen.
Quick Menu screen appears.
- 2 Touch [SETUP].
- 3 Touch [System].



System screen appears.

See the following section for each setting.

- Set up the user interface ([P.125](#))
- Adjust touch panel ([P.126](#))
- Set up security ([P.126](#))
- Set up memory ([P.127](#))

User interface

You can setup user interface parameters.

- 1 Touch [User Interface] in the list.
User Interface screen appears.
- 2 Set each item as follows.



Beep

Turns the key touch tone on or off.
Default is "ON".

Language

Select the language used for the control screen and setting items. See [Language setup \(P.126\)](#).



Text Scroll

Allows scrolling of text display on the source control screen. Select from "Auto"/"Once"/"OFF".

Auto (Default): Scrolls the text automatically.

Once: Allows you to scroll the text only once automatically when updated.

OFF: Does not scroll the text automatically.

NAV Key Longer than 1 Second/ APPS Key Longer than 1 Second (DNN9250DAB/ DNR8025BT)

You can set the operation performed when the NAV/ APPS key is pressed for 1 second. Select from "V.OFF"/"CAM".

V.OFF (Default): Turn the display off.

CAM: Switches to the front or rear view camera video display.*

Secondary (DNN9250DAB/ DNN6250DAB)

Set whether to display the navigation information in the audio screen or vice versa.
Default is "ON".

Vehicle Information

Displays the vehicle information.

This function requires a commercial adaptor.
Consult your Kenwood dealer for details.

DEMO

Set the demonstration mode. Default is "ON".

- * When you set [Front Camera] to OFF, the display will change to the rear view camera and when you set it to "CMOS-3xx"/"Other", the display will change to the front view camera. See [Camera Setup \(P.131\)](#)

Language setup

1 Touch [SET] of [Language] in the User Interface screen.

Language Setting screen appears.

2 Set each item as follows.



GUI Language Select

Select the language used for the GUI and input methods.

ASR (DNN9250DAB)

Select the language used for voice control function.

Navigation Language Select (DNN9250DAB/ DNN6250DAB)

Select the language used for navigation.

STT

Select the language used for Speech to Text (STT).

TTS

Select the language used for Text to Speech (TTS).

3 Touch [Enter].

NOTE

- To cancel the language setup, touch [Cancel].

Touch panel adjustment (DNN6250DAB)

1 Touch [Touch] in the System Menu screen.

Touch Panel Adjustment screen appears.

2 Follow the instruction on the screen and touch the center of each .

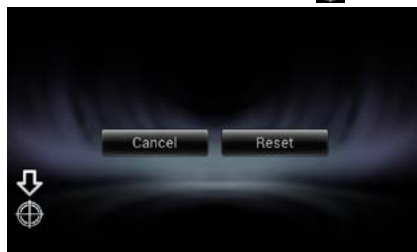

NOTE

- To cancel the touch panel adjustment, touch [Cancel].
- To reset to the initial status, touch [Reset].

Security setup

A red indicator will blink on the unit after the ACC is set to OFF, warning potential thieves.

If turned to "ON" (default), the security indicator on the front panel flashes when the vehicle ignition is off.

1 Touch [Security] in the System Menu screen.

Security screen appears.

2 Touch [ON] or [OFF] of [SI].

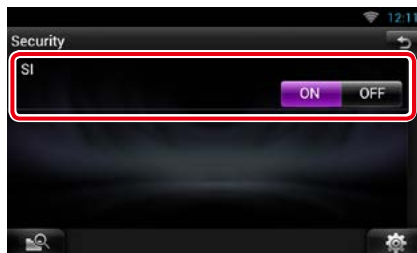

Setup memory

Audio Control, AV-IN SETUP, Camera, and Audio SETUP settings can be memorized. The memorized settings can be recalled at any time. For example, even when the settings are cleared due to replacement of the battery, the settings can be restored.

1 Touch [SETUP Memory] in the System Menu screen.

SETUP Memory screen appears.

2 Follow the instruction on the screen.

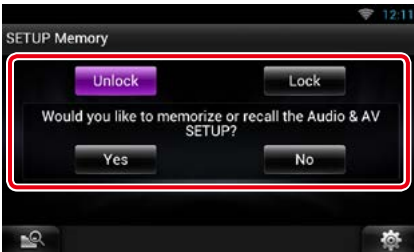

[Lock] / [Unlock]*

Locks or unlocks the AV-IN SETUP, and Audio SETUP settings.

Yes

Memorizes or recalls the settings.

No

Cancels the function or memorization.
The SETUP Menu screen appears again.

*** When [Lock] is selected, you cannot change the AV-IN SETUP, and Audio SETUP settings. Also, the locked key mark is displayed under each setting icon in the setup menu.**

3 Follow the instruction on the screen.



Recall

Recalls the memorized settings.

Memory

Memorizes the current settings.

Clear

Clears the currently memorized settings.

Cancel

Cancels memorization/recalling of settings.

Display Setup

- 1 Touch [] on any screen.
- 2 Touch [SETUP].
SETUP Menu screen appears.
- 3 Touch [Display].



Display screen appears.

See the following section for each setting.

- **Control monitor angle** ([P.128](#))
- **Adjust panel color** ([P.129](#))

Monitor angle control (DNN9250DAB/ DNR8025BT)

You can adjust the angle of the monitor.

- 1 Touch [Angle] in the Display Menu screen.
Angle setup screen appears.
- 2 Select a number below an angle that will best suit your monitor viewing.

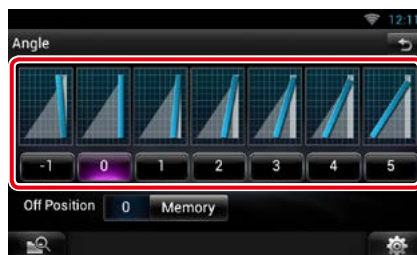

Default is "0".

NOTE

- You can store the current monitor angle as the angle during power off. Touch [Memory] when the desired angle is selected.

Panel color coordinate

You can set the button illumination color. The selectable items differ depending on the unit.

1 Touch [Color] in the Display Menu screen.

Color screen appears.

2 Touch [SET] of [Panel Color Coordinate].

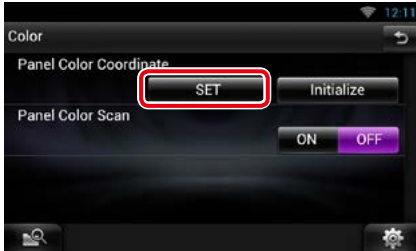

Panel Color Coordinate screen appears.

NOTE

- You can touch [SET] or [Initialize] when [Panel Color Scan] is set to off.
- Touch [Initialize] to reset the settings to the default settings.

3 Touch the desired color.



Registering original color

You can register your original color.

1 Touch [Adjust] in the Panel Color Coordinate screen.

Panel Color RGB Coordinate screen appears.

2 Use [◀] and [▶] to adjust each color value.



3 Touch the desired preset key for 2 seconds.

Panel color scan

You can set the panel color to continuously scan through the color spectrum.

1 Touch [ON] of [Panel Color Scan] in the Color screen.

Panel Color Scan is set to on.

Navigation Setup (DNN9250DAB/ DNN6250DAB)

You can set navigation parameters.

- 1 Touch [] on any screen.
- 2 Touch [SETUP].
SETUP Menu screen appears.
- 3 Touch [Navigation].



Navigation SETUP screen appears.

- 4 Set each item as follows.



NAV Interrupt Speaker

Select speaker(s) used for voice guidance of the navigation system.

Front L: Uses the front left side speaker for voice guidance.

Front R: Uses the front right side speaker for voice guidance.

Front All (Default): Uses both front speakers for voice guidance.

NAV Voice Volume

Adjust the volume for voice guidance of the navigation system. Default is "20".

NAV Mute

Mutes the volume of rear speakers during voice guidance of the navigation system. Default is "ON".

Camera Setup

You can set camera parameters.

- 1 Touch [] on any screen.
- 2 Touch [SETUP].
SETUP Menu screen appears.
- 3 Touch [Camera].



Camera SETUP screen appears.

- 4 Set each item as follows.



Rear Camera*¹ (DNN9250DAB/ DNR8025BT)

Select the type of rear camera to use.

CMOS-310: When the CMOS-3xx series with ID 1 set is connected.

Other (Default): When the other camera is connected.

R-CAM Interruption

Set a method for switching the display. Setting values are ON and OFF.

ON: Switches to the rear view camera video display when shifting to reverse or pressing the <NAV>*⁴/<>APPS>*⁴ button for 1 second.

OFF (Default): Switches to the rear view camera video display when pressing the <NAV>*⁴/<>APPS>*⁴ button for 1 second.

R-CAM Settings*² (DNN9250DAB/ DNR8025BT)

Adjust the CMOS-3xx series with ID 1 set. For details, see the instruction manual of your camera.

Front Camera*¹ (DNN9250DAB/ DNR8025BT)

Select the type of front camera to use.

CMOS-310: When the CMOS-3xx series with ID 2 set is connected.

Other: When the other camera is connected.

OFF (Default): When the front camera is not used.

F-CAM Settings*³ (DNN9250DAB/ DNR8025BT)

Adjust the CMOS-3xx series with ID 2 set. For details, see the instruction manual of your camera.

*¹ These settings become settable only when the parking brake is on.

*² This setting becomes settable only when the parking brake is on and the CMOS-3xx series is selected.

*³ This setting becomes settable only when the parking brake is on and "Front Camera" is set to [ON].

*⁴ [NAV/APPS Key Longer than 1 Second] must be set to "CAM". See [User interface \(P.125\)](#).

Software Information

Check the software version of this unit.

- 1 Touch [] on any screen.
- 2 Touch [SETUP].
SETUP Menu screen appears.
- 3 Touch [Software].



Software Information screen appears.

- 4 Confirm the software version. Touch [Update] as necessary.

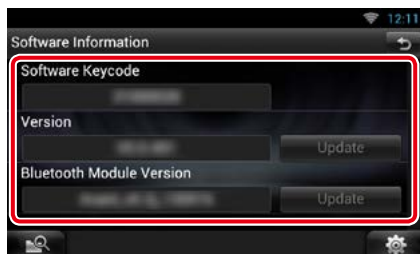

NOTE

- For how to update the software, see the relevant update procedure manual which comes with the software.

Notify the update

When the program is updated you will be notified by the  icon on the status bar.

Preparation

- You need to connect to Internet.

Minor update

If it is the minor update you can update the program via the Internet.

- 1 Drag the status bar downward.

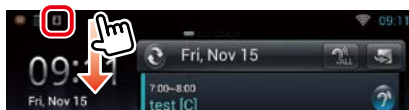

- 2 Touch [Download] to start download.

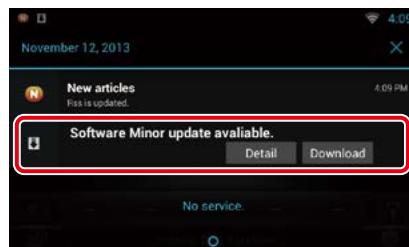

Touch [Detail] to display details.

- 3 Touch [Update].

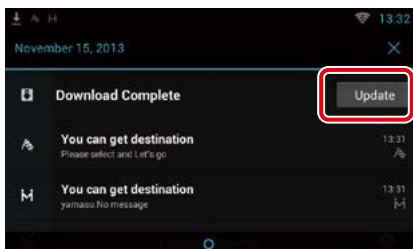

- 4 Touch [Update] to update starts.



When the update is complete "Update completed" appears.

AV Input Setup

You can set AV input parameters.

- 1 Touch [] on any screen.
- 2 Touch [SETUP].
SETUP Menu screen appears.
- 3 Touch [Source].



- 4 Touch [AV-IN SETUP] in the list.
AV-IN SETUP screen appears.

- 5 Set each item as follows.



TV Tuner Control

Sets when connecting the TV tuner to AV INPUT.

ON: Set to ON when connecting the 3rd party TV tuner. AV-IN Name is set to TV. If you connect the TV tuner made by DOS and watch TV, you can perform some simple operations by touching the screen of this unit.

OFF (Default): Set to OFF when not connecting the 3rd party TV tuner.

AV-IN1 Name / AV-IN2 Name

Set a name to be displayed when you select a system that is connected via the AV INPUT port. Default is "VIDEO".

AV Output Interface Setup

You can select an AV source to be output at the AV OUTPUT port. Default is "VIDEO1".

- 1 Touch [] on any screen.
- 2 Touch [SETUP].
SETUP Menu screen appears.
- 3 Touch [AV-OUT].

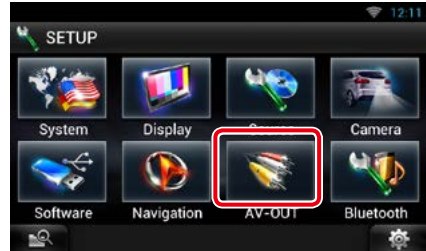

AV-OUT Interface screen appears.

- 4 Touch [◀] or [▶] to set [AV-OUT] to VIDEO, DISC, iPod, or OFF.

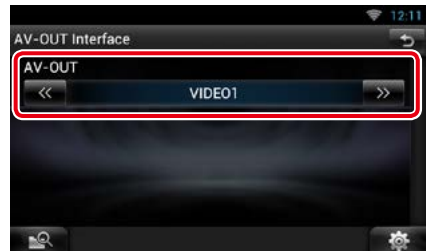

NOTE

- You can select "iPod" only when iPod is connected to this unit with KCA-iP202. For the connection setting, refer to [iPod/iPhone connection setup \(P.85\)](#).

Controlling Audio

NOTE

- Each operation in this section can be started from the multi function menu.

You can adjust the various settings such as audio balance or subwoofer level.

1 Touch [] on any screen.

2 Touch [Audio].

Audio screen appears.

See the following section for each setting.

- **Setting audio** ([P.134](#))
- **Controlling audio** ([P.137](#))
- **Controlling equalizer** ([P.138](#))
- **Controlling sound effect** ([P.140](#))
- **Performing zone control** ([P.139](#))
- **Set listening position** ([P.142](#))

Setting Audio

1 Touch [] on any screen.

2 Touch [Audio].

Audio screen appears.

3 Touch [Audio SETUP].

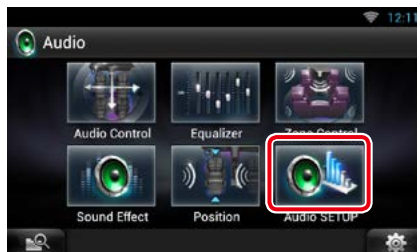

Audio SETUP screen appears.

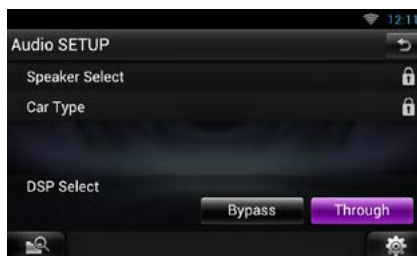

See the following section for each setting.

- **Set up speakers** ([P.135](#))
- **Set up your car type** ([P.136](#))
- **Select DSP** ([P.137](#))

Speaker setup

You can select a speaker type and its size to get the best sound effects.

When the speaker type and size are set, the speaker crossover network is set automatically.

1 Touch [Speaker Select] in the Audio SETUP screen.

Speaker Select screen appears.



2 Touch the speaker you wish to adjust and set each item as follows.

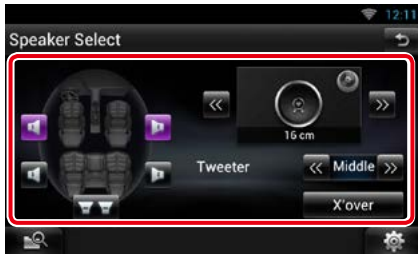

Tweeter (DNN9250DAB/ DNR8025BT)

You can set the tweeter when you are selecting front speakers.

None, Small, Middle, Large

X'over

Displays the speaker crossover setup screen.

You can adjust the crossover setup that was set automatically when you selected the speaker type.

For details, see [Crossover network setup \(P.136\)](#)

3 Select a speaker size using [◀] and [▶]. The speaker size is different depending on the speaker type and the unit.

Front

OEM, 8 cm, 10 cm, 12 cm, 13 cm, 16 cm, 17 cm, 18 cm, 4x6, 5x7, 6x8, 6x9, 7x10

Rear

None, OEM, 8 cm, 10 cm, 12 cm, 13 cm, 16 cm, 17 cm, 18 cm, 4x6, 5x7, 6x8, 6x9, 7x10

Subwoofer

None, 16 cm, 20 cm, 25 cm, 30 cm, 38 cm over

NOTE

- Select "None" if you have no speakers.

Crossover network setup

You can set a crossover frequency of speakers.

- 1 Touch the speaker to set the crossover in the Speaker Select screen.
- 2 Touch [X'over].
X'over screen appears.
- 3 Set each item as follows.



TW (Tweeter) Gain *1 (DNN9250DAB/ DNR8025BT)

Adjust the tweeter level. (When front is selected on Speaker Select screen)

Gain

Adjust the front speaker, rear speaker, or subwoofer level.

Phase *2

Set the phase of subwoofer output.

The phase is reversed 180 degrees when set to "Reverse". (When subwoofer is selected on Speaker Select screen)

HPF FREQ

High Pass Filter adjustment. (When front or rear speaker is selected on Speaker Select screen)

LPF FREQ

Low Pass Filter adjustment. (When subwoofer is selected on Speaker Select screen)

Slope *3

Set a crossover slope.

- *1 Only when "Tweeter" is set to "Small", "Middle", "Large" in <Speaker Setup>.
- *2 Only when "Subwoofer" is set to a mode other than "None" in <Speaker Setup>.
- *3 Only when "LPF FREQ"/"HPF FREQ" is set to a mode other than "Through" in <X'over>.

Car type setup

You can setup the car type and speaker network, etc.

- 1 Touch [Car Type] in the Audio SETUP screen.
Car Type screen appears.
- 2 Select your car type from the list.

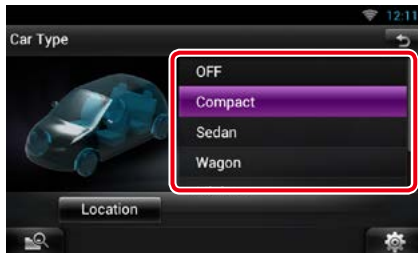

NOTE

- If your car type is selected, the Delay Time Alignment is set automatically (for timing adjustment of sound output for each channel) to have the highest surround effects.

Speaker location setup

- 1 In the Car Type screen, touch [Location].
Speaker Location screen appears.
- 2 Select the speaker locations using [▶].



Front Speaker

Select the location from "Door"/"On Dash"/"Under Dash".

Rear Speaker

Select the location from "Door"/"Rear Deck", "2nd Row"/"3rd Row" (Minivan, Passenger Van).

DSP select

You can select whether using DSP (Digital Signal Processor) System.

1 Touch [Bypass] or [Through] of [DSP Select] in the Audio SETUP screen.

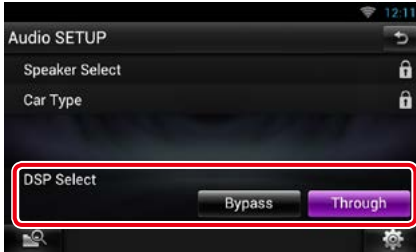

Bypass

There is no effect by DSP.

Through

There is an effect by DSP.

NOTE

- When the mode is set to [Bypass], DSP System cannot be adjusted.

Controlling General Audio

1 Touch [] on any screen.

2 Touch [Audio].

Audio screen appears.

3 Touch [Audio Control].



4 Set each item as follows.

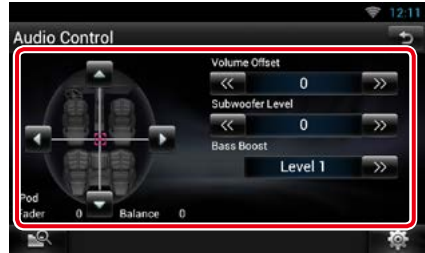

Fader # / Balance

Adjust the volume balance around the touched area.

[◀] and [▶] adjust the right and left volume balance.

[▲] and [▼] adjust the front and rear volume balance.

Volume Offset*

Finely adjust the volume of the current source to minimize the difference in volume between different sources.

Subwoofer Level

Adjust the subwoofer volume. This setting is not available when subwoofer is set to "None". See [Speaker setup \(P.135\)](#).

Bass Boost

Set the amount of bass boost among "OFF"/"Level1"/"Level2"/"Level3".

* If you have increased the volume first, then reduced the volume using the "Volume Offset", the sound generated if you suddenly switch to another source may be extremely loud.

Equalizer Control

You can adjust equalizer by selecting the optimized setting for each category.

- 1 Touch [] on any screen.
- 2 Touch [Audio].
Audio screen appears.
- 3 Touch [Equalizer].

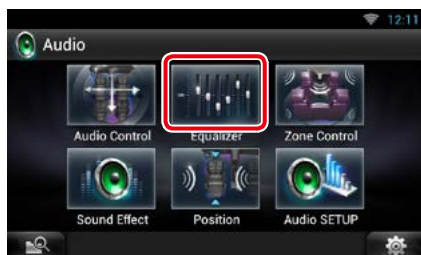

Equalizer screen appears.

Controlling EQ curves

- 1 Select EQ curve from [Natural], [Rock], [Pops], [Easy], [Top40], [Jazz], [Powerful], [iPod], and [User].



NOTE

- [iPod] is available only during iPod source.

Controlling equalizer manually

The Graphic Equalizer cannot be set when you select [iPod] in the Equalizer screen.

- 1 Touch [EQ] in the Equalizer screen.
- 2 Touch the screen and set the Graphic Equalizer as desired.

DNN9250DAB/ DNR8025BT



DNN6250DAB



Gain level (light green boxed area)

Adjust the gain level by touching the each frequency bar.

Touching [◀], [▶], [▲] and [▼] can also adjust the level. Use [◀] and [▶] to select a frequency, and [▲] and [▼] to set the level.

EQ INIT

Returns to the previous level which the gain level is adjusted.

Flat

Tone curve becomes flat.

Bass EXT (Bass Extend Settings)

When turned on, the frequency lower than 62.5 Hz is set to the same gain level as 62.5 Hz.

Loudness

Set the amounts of boost of low and high tones.

DNN9250DAB/ DNR8025BT: "OFF", "Low", "High"

DNN6250DAB: "OFF", "ON"

SW Level

Adjust the subwoofer volume. This setting is not available when subwoofer is set to "None". See [Speaker setup \(P.135\)](#).

Zone Control

You can select different sources for both front and rear positions in the vehicle.

1 Touch [] on any screen.

2 Touch [Audio].

Audio screen appears.

3 Touch [Zone Control].

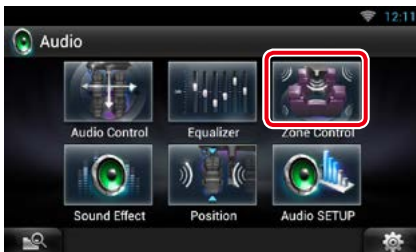

Zone Control screen appears.

4 Touch [Dual Zone].



5 Set each source as follows.



[▶] (Front Source, Rear Source)

Select the audio source for each.

[▼], [▲] (Rear VOL.)

Adjust the rear channel volume.

[Single Zone]

Touch to turn off the dual zone function.

NOTE

- When the rear speaker sound is switched, the audio source that is output at the AV OUTPUT terminal is also switched to the same source.
- When the dual zone function is set to on, the following functions are not available.
 - Output from the subwoofer
 - Subwoofer Level/Bass Boost ([P.137](#))
 - Equalizer Control/Sound Effect/Listening Position ([P.138, 140, 142](#))
 - DSP Bypass Control/Speaker Setup/Car Type Setup ([P.137, 135, 136](#))

Sound Effect

You can set sound effects.

- 1 Touch [] on any screen.
- 2 Touch [Audio].
Audio screen appears.
- 3 Touch [Sound Effect].



Sound Effect screen appears.

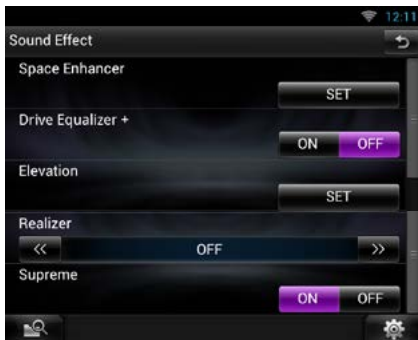

See the following section for each setting.

- Set space enhancer [\(P.140\)](#)
- Set Drive Equalizer +/- Drive Equalizer [\(P.141\)](#)
- Set up elevation [\(P.141\)](#)
- Set up realizer or supreme [\(P.141\)](#)

Space Enhancer (DNN9250DAB/ DNR8025BT)

- 1 Touch [Space Enhancer] in the Sound Effect screen.

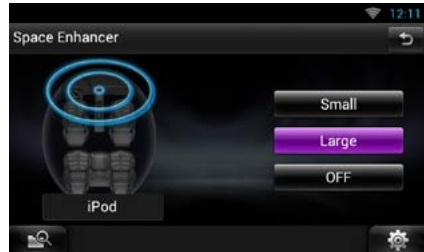

Space Enhancer screen appears.

- 2 Touch [Small], [Large], or [OFF].
Each setting value indicates the soundscape level.

Drive Equalizer + / Drive Equalizer

Drive Equalizer+ (DNN9250DAB):
The sound quality is automatically optimized to meet the current car speed by GPS.

Drive Equalizer (DNR8025BT/ DNN6250DAB):
The sound quality is automatically optimized to meet the current volume level.

- 1 Touch [ON] or [OFF] of [Drive EQ+ / Drive EQ].

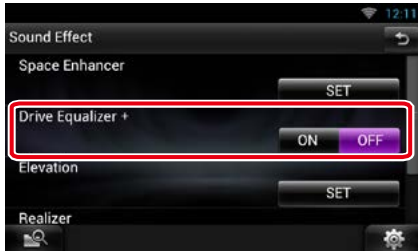

Elevation (DNN9250DAB/ DNR8025BT)

You can raise the sound position heard from the speakers virtually.

- 1 Touch [Elevation] in the Sound Effect screen.



Elevation screen appears.

- 2 Select Elevation level from [High], [Low], and [OFF].

Realizer and Supreme (DNN9250DAB/ DNR8025BT)

You can restore the sound lost due to audio compression to a realistic sound.

- 1 Touch the screen in the Sound Effect screen.



Realizer

Realizer is sound enhancement and boosting low frequencies (bass boost).

Select the level from "OFF"/"Level1"/"Level2"/"Level3".

Supreme

Turns ON/OFF the Supreme function.

Technology to extrapolate and supplement with proprietary algorithm, the high-frequency range that is cut off when encoding.

This function works on DVD MEDIA, USB, SD and iPod sources.

Listening Position

You can adjust the sound effects according to your listening position.

- 1 Touch [] on any screen.
- 2 Touch [Audio].
Audio screen appears.
- 3 Touch [Position].



Position screen appears.

- 4 Select listening position from [Front R] (Right front), [Front L] (Left front), [Front All] (All front), and [All] using [◀] and [▶].



Position DTA Control

You can fine-adjust your listening position.

- 1 In Position screen, touch [Adjust].
- 2 Select the speaker you wish to adjust by touching speaker icon.



- 3 Set DTA as follows.



[◀], [▶]

Adjust the settings of the DTA position.

Gain

Touch to adjust the gain of each speaker.

Initialize

Initializes the setting values.

NOTE

- Make fine adjustment of the delay time of the speaker output specified here to have a more suitable environment for your vehicle.
- If you specify the distance from the center of the currently set listening position to every speaker, the delay time will be automatically computed and set.
 - ① Determine the center of the currently set listening position as the reference point.
 - ② Measure the distances from the reference point to the speakers.
 - ③ Calculate the differences between the distance of the furthest speaker and other speakers.
 - ④ Input the differences calculated in step 3 for individual speakers.
 - ⑤ Adjust gain for individual speakers. A sound image will be shifted to the speaker with increased gain.

Example: When [Front All] is selected as the listening position

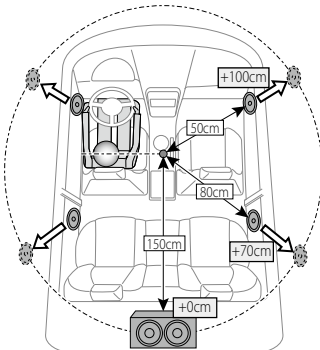

Remote Control

This unit can be operated using the remote control.

For DNN9250DAB, the remote control is supplied with the unit.

For DNN6250DAB and DNR8025BT, the remote control is the optional accessory (KCA-RCDV331).

▲CAUTION

- Put the remote control in a place where it will not move during braking or other operations. A dangerous situation could result, if the remote control falls down and gets wedged under the pedals while driving.
- Do not leave the battery near fire or under direct sunlight. A fire, explosion or excessive heat generation may result.
- Do not recharge, short, break up or heat the battery or place it in an open fire. Such actions may cause the battery to leak fluid. If spilled fluid comes in contact with your eyes or on clothing, immediately rinse with water and consult a physician.
- Place the battery out of reach of children. In the unlikely event that a child swallows the battery, immediately consult a physician.

Battery Installation

If the remote control operates only over shorter distances or does not operate at all, it is possible that the batteries are depleted.

In such instances, replace the both batteries with new ones.

- 1** Insert two "AAA"/"R03"-size batteries with the ⊕ and ⊖ poles aligned properly, following the illustration inside the case.

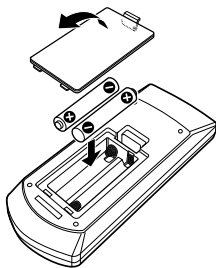

Functions of the Remote Control Buttons

Switching the operation mode

The functions operated from the remote control differ depending on the position of the mode switch.

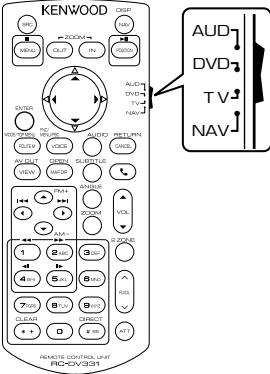

AUD mode

Switch to this mode when controlling a selected source or tuner source, etc.

DVD mode

Switch to this mode when playing a disc media including DVD, VCD, and CD.

NAV mode

Switch to this mode when controlling navigation function.

NOTE

- When controlling a player that is not integrated in the unit, select "AUD" mode.

Direct search mode

Using the remote control, you can jump directly to the desired file, track chapter, etc. with entering the number corresponding to the content.

NOTE

- This operation cannot be performed for USB device and iPod.

1 Press the <#BS> button several times until the desired content appears.

The available contents are different depending on the source.

DVD

Title number/Chapter number/Play time/Item number*

* You may not be able to use this function with some discs or scenes.

VCD 1.X and 2.X (PBC OFF)

Track number

VCD 2.X (PBC ON)

Scene number/number

Music CD

Track number/Play time

Audio files

Folder number/File number

Radio

Frequency value

2 Enter the number of the content you want to play using the numeric keypad.

3 For DVD or VCD, press the <POSITION> button.



For music CD or audio files, press the <POSITION> button.

For radio, press the <<> or <>> button.

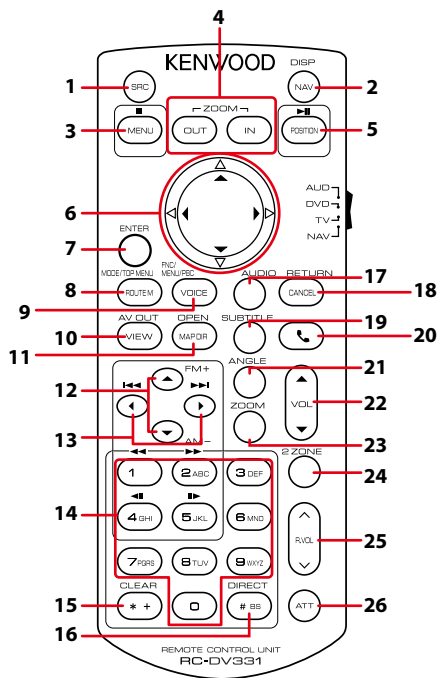
The content you entered is played.



	Key Name	Location of the mode switch	Function
1	SRC	AUD, DVD	Switches to the source to be played. In hands-free mode, hangs up the phone.
2	NAV	—	Switches between the navigation and the source screens.
3	MENU	DVD	Stops playing and memorizes the last point where the disc stopped. The last point is deleted by pressing twice.
		NAV	Displays Main menu.
4	OUT, IN	NAV	Zooms in or out the navigation map.
5	POSITION	AUD, DVD	Pauses the track or file, and resumes playing by pressing twice. During radio source in AUD mode, switches the seek mode.
		NAV	Displays the current position.
6	Cursor Key	DVD	Moves the cursor in the DVD menu.
		NAV	Moves the cursor or scrolls the map.
7	ENTER	DVD	Performs the selected function.
		NAV	<ul style="list-style-type: none"> Registers the selected position. Performs the selected function.
8	ROUTE M	AUD	Screen mode changes each time you press this key during video playback.
		DVD	Returns to the DVD top menu.
		NAV	Displays Route Option menu.

	Key Name	Location of the mode switch	Function
9	VOICE	AUD	Switches navigation display on/off.
		DVD	Displays the DVD menu. Turns the playback control on or off while playing VCD.
		NAV	Speaks the voice guidance.
10	VIEW	AUD, DVD	Switches the AV source to be output.
		NAV	Switches between 2D and 3D map displays.
11	MAP DIR	AUD, DVD	Switches the display angle each time it is pressed.
		NAV	Switches between the heading up navigation and north up navigation map displays.
12	▲/▼	AUD, DVD	Selects the folder to be played. During radio source in AUD mode, switches the bands to be received.
13	◀▶	AUD, DVD	Selects the track or file to be played. During radio source in AUD mode, switches to broadcast stations received by the unit.
14	Numeric Keypad	AUD	Specifies the number to search in direct search. For details on the direct search mode, see Direct search mode (P.145) .
		DVD	<ul style="list-style-type: none"> • Press [1] [2] to fast forward/backward. Switches the fast forward/backward speed each time you press this key.* • Press [4] [5] to slow forward/backward. Switches the slow playback speed each time you press this key.* *DVD only
15	* +	DVD	Clears the number.
16	# BS	AUD, DVD	Switches to the direct search mode. For details on the direct search mode, see Direct search mode (P.145) .
17	AUDIO	DVD	Switches the voice language each time you press this key.
18	CANCEL	DVD	Displays previous screen.
		NAV	Cancels the operations.
19	SUBTITLE	DVD	Switches the subtitle language.
20		–	When a call comes in, answers the call.
21	ANGLE	DVD	Switches the picture angle each time you press this key.
22	Vol ▲▼	–	Adjusts the volume.
23	ZOOM	DVD	Switches the zoom ratio (1, 2, 3, Off) each time you press this key.
24	2 ZONE	AUD, DVD	Switches the Dual Zone function on and off.
25	R.VOL 	–	Adjusts volume at rear when the Dual Zone function is on.
26	ATT	–	Lowers the volume by pressing the key once. Restores the previous volume by pressing the key twice.

Troubleshooting

Problems and Solutions

If any trouble occurs, first check the following table for possible problems.

- Some functions of this unit may be disabled by some settings made on this unit.
- What might seem to be a malfunction in your unit may just be the result of slight misoperation or miswiring.

About settings

Problem	Reason	Solution
<ul style="list-style-type: none"> • Cannot set up the subwoofer. • Cannot set up subwoofer phase. 	Subwoofer is not set to on.	Set the subwoofer to on. See Speaker setup (P.135) .
<ul style="list-style-type: none"> • No output from the subwoofer. • Cannot set up the low pass filter. • Cannot set up the high pass filter. 	The dual zone function is enabled.	Set the dual zone function to off. See Zone Control (P.139) .
<ul style="list-style-type: none"> • Cannot select the output destination of the subsource in the dual zone. • Cannot adjust the volume of the rear speakers. 	The dual zone function is disabled.	Set the dual zone function to on. See Zone Control (P.139) .
<ul style="list-style-type: none"> • Cannot set up the equalizer. • Cannot set up the crossover network. 	The dual zone function is enabled.	Set the dual zone function to off. See Zone Control (P.139) .
	"DSP Select" is set to "Bypass".	Set "DSP Select" to "Through". See DSP select (P.137) .

About audio operations

Problem	Reason	Solution
Radio reception is poor.	The car antenna is not extended.	Pull out the antenna all the way.
	The antenna control wire is not connected.	Connect the wire correctly. See "Connection" in the Quick Start Guide.
Cannot play audio files stored in a disc.	"CD Read" is set to "2".	Set "CD Read" to "1". See Disc setup (P.71) .
Cannot select a folder.	The random play function is enabled.	Turn off the random function.
Cannot perform repeat play during VCD playback.	The PBC function is enabled.	Turn off the PBC function.
The specified disc does not play, but another one plays instead.	The disc is quite dirty.	Clean the disc. See Precautions on handling discs (P.4) .
	The disc is severely scratched.	Try another disc instead.

Problem	Reason	Solution
The sound skips when an audio file is being played.	The disc is scratched or dirty.	Clean the disc. See Precautions on handling discs (P.4) .
	The recording condition is bad.	Record the file again or use another disc.
Video or audio is interrupted on Streaming Video and AUPEO!	The communication environment is not stable.	Video or audio may be interrupted depending on the communication environment and this unit's operation condition.
	Video or audio is playing in the background.	

Other

Problem	Reason	Solution
The Touch Sensor Tone doesn't sound.	The preout jack is being used.	The Touch Sensor Tone cannot be output from the preout jack.

Error Messages

When you fail to operate the unit correctly, the cause of the failure appears as the message on the screen.

Error Message	Cause	Solution
Protect	Protective circuit has been activated because a speaker cord has shorted or it has come in contact with the car chassis.	Wire or insulate the speaker cord as appropriate and then press the <Reset> button (P.151) .
Hot Error	When the internal temperature of this unit rises to 60°C or more, the protection circuit is activated and you may not be able to operate the unit.	Use the unit again after reducing the temperature of the unit.
Mecha Error	The disc player is malfunctioning.	Eject the disc and try inserting it again. Contact the Kenwood dealer if this indicator continues blinking or the disc cannot be ejected.
Disc Error	An unplayable disc is inserted.	Change the disc. See Playable Media and Files (P.152) .
Read Error	The disc is quite dirty.	Clean the disc. See Precautions on handling discs (P.4) .
	Disc is upside down.	Load the disc with the labeled side up.
Region Code Error	The disc you wanted to play has a region code that cannot be played with this unit.	See Region Codes in the World (P.157) or try another disc.
Parental Level Error	The disc you wanted to play has a higher level than the parental level you set.	Set the parental level. See Parental level (P.71) .

Error Message	Cause	Solution
Error 07–67	The unit is not operating correctly due to some reason or other.	Push the unit's Reset button. If the "Error 07–67" message does not disappear, see your nearest Kenwood dealer.
No Device (USB device)	The USB device is selected as a source although no USB device is connected.	Change the source to any source other than USB/iPod. Connect a USB device, and change the source to USB again.
Disconnected (iPod, Bluetooth audio player)	The iPod/Bluetooth audio player is selected as a source although no iPod/Bluetooth audio player is connected.	Change the source to any source other than iPod/Bluetooth. Connect an iPod/Bluetooth audio player, and change the source to iPod/Bluetooth again.
No Media file	The connected USB device contains no playable audio file. Media was played that doesn't have data recorded that the unit can play.	See Playable Media and Files (P.152) and try another USB device.
USB Device Error!!	The connected USB device is rated a current capacity higher than the allowable limit.	Check the USB device. Some trouble may have occurred to the connected USB device. Change the source to any source other than USB. Remove the USB device.
Authorization Error	Connection to the iPod has failed.	<ul style="list-style-type: none"> • Remove the iPod and then reconnect it. • The unit does not support the iPod. See Connectable iPod/iPhone (P.154) .
Update your iPod	The iPod's software is an older version which the unit can not support.	The unit may not support the connected iPod model. Confirm that the software for the iPod is the latest version. See Connectable iPod/iPhone (P.154) .
Navigation Error. Please turn on power again later.	The communication error has occurred due to severely cold temperature.	Turn on power again after warming your car interior.
Network is disconnected	Not connected to Wi-Fi.	Connect to Wi-Fi.
Your Dropbox and Kenwood accounts are not linked.	Dropbox account information is not registered to the logged in Owner or User account.	Log in Route Collector site and register the Dropbox account

Resetting the Unit

If the unit or the connected device fails to operate properly, reset the unit.

1 Press the <Reset> button.

The unit returns to factory settings.

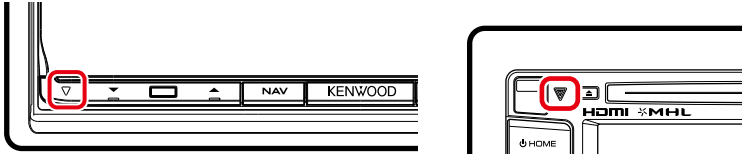

NOTE

- Disconnect the USB device before pressing the <Reset> button. Pressing the <Reset> button with the USB device connected can damage the data stored in the USB device. For how to disconnect the USB device, see [How to Play Media \(P.20\)](#).
- When the unit is turned on after resetting, the Initial SETUP screen appears. See [Initial setup \(P.16\)](#).

Appendix

Playable Media and Files

You can play various kinds of media and files on this unit.

List of playable discs

Disc types	Standard	Support	Remark
DVD	DVD Video	○	
	DVD Audio	×	
	DVD-VR	×	
	DVD-R*1	○	<ul style="list-style-type: none"> • MP3/WMA/AAC/MPEG1/MPEG2/DivX playback • Multi-border/Multisession playback (Playback depends on authoring conditions)
	DVD-RW	○	
	DVD+R	○	
	DVD+RW	○	
	DVD-R DL (Dual layer)	○	Only video format
DVD+R DL (Double layer)	○		
DVD-RAM	×		
CD	Music CD*1	○	CD-TEXT
	CD-ROM	○	<ul style="list-style-type: none"> • MP3/WMA/AAC/MPEG1/MPEG2/DivX playback
	CD-R	○	<ul style="list-style-type: none"> • Multisession is supported.
	CD-RW	○	<ul style="list-style-type: none"> • Packet write is not supported.
	DTS-CD	×	
	Video CD (VCD)	○	
	Super video CD	×	
	Photo CD	×	
	CD-EXTRA	△	Only music CD session can be played.
	HDCD	○	
CCCD	×		
Others	Dualdisc	×	
	Super audio CD	△	Only CD layer can be played.

*1 Incompatible with 8 cm (3 inch) discs.

○ : Playback is possible.

△ : Playback is partly possible.

×

 : Playback is impossible.

NOTE

- When buying DRM enabled content, check the Registration Code in the [DivX® VOD \(P.88\)](#). Each time a file with the displayed code is played and protected against copying, the code changes.
- DivX can be played only from a DVD disc media.

● Use of DualDisc

When playing a "DualDisc" on this unit, the surface of the disc that is not played may be scratched while the disc is inserted or ejected. Since the music CD surface does not conform to the CD standard, playback may be impossible.

(A "DualDisc" is a disc with one surface containing DVD standard signals and the other surface containing music CD signals.)

● About disc format

The disc format should be the one of the following.

- ISO 9660 Level 1/2
- Joliet
- Romeo
- Long file name



About files

The following audio, video, and picture files are supported.

● Audio files

- AAC-LC (.m4a)
- MP3 (.mp3)
- WMA (.wma)
- Linear PCM (WAVE) (.wav)
*Mass-storage-class USB device only
- FLAC (.flac)
*Mass-storage-class USB device only

NOTE

- If music of normal CD and other playback systems are recorded in the same disc, only the playback system recorded at the first setout is played.
- WMA and AAC of which is covered with DRM cannot be played.
- Although the audio files are complied with the standards listed above, the play may be impossible depending on the types or conditions of media or device.
- An online manual about audio files is posted on the site, www.kenwood.com/cs/ce/audiofile/. On this online manual, detailed information and notes which are not written in this manual are provided. Make sure to read through the online manual as well.

● Video files

- MPEG1 (.mpg, .mpeg, .m1v)
- MPEG2 (.mpg, .mpeg, .m2v)
- DivX (.divx, .div, .avi)
*Only for DVD
- H.264/MPEG-4 AVC (.mp4, .m4v)
*Mass-storage-class USB device only
- WMV 9 (.wmv, .m2ts)
*Mass-storage-class USB device only
- MKV (.mkv)
*Mass-storage-class USB device only

● Picture files

Only picture files in USB device can be displayed.

Files stored in disc media is not supported.

- JPEG (.jpg, .jpeg)
- PNG (.png)
- BMP (.bmp)

NOTE

- BMP and PNG can be set only as wallpaper.

● Playing order of files

In the example of folder/file tree shown below, the files are played in the order from ① to ⑩.

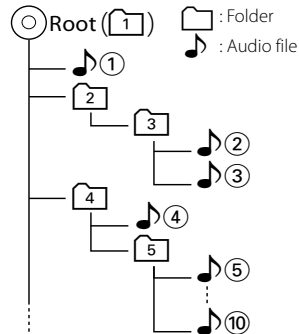

Connectable iPod/iPhone

The following models can be connected to this unit.

Made for

- iPhone 5
- iPhone 4S
- iPhone 4
- iPhone 3GS
- iPhone 3G
- iPhone
- iPod touch (5th generation)
- iPod touch (4th generation)
- iPod touch (3rd generation)
- iPod touch (2nd generation)
- iPod touch (1st generation)
- iPod classic
- iPod with video
- iPod nano (7th generation)
- iPod nano (6th generation)
- iPod nano (5th generation)
- iPod nano (4th generation)
- iPod nano (3rd generation)

NOTE

- For the details of the necessary cable and adapter to connect with iPod/iPhone, refer to [Music/Video Basic Operation \(P.72\)](#).
- For the conformity information on iPod/iPhone software, access www.kenwood.com/cs/ce/ipod/.
- By connecting your iPod/iPhone to this unit with an optional accessory iPod connection cable (KCA-IP202 or KCA-IP102), you can supply power to your iPod/iPhone as well as charge it while playing music. However, the power of this unit must be on.
- If you start playback after connecting the iPod, the music that has been played by the iPod is played first.
In this case, "Reading" is displayed without displaying a folder name, etc. Changing the browse item will display a correct title, etc.
- When the iPod is connected to this unit, "KENWOOD" or "✓" is displayed on the iPod to indicate that you cannot operate the iPod.

Usable USB device

You can use a mass-storage-class USB device on this unit.

The word "USB device" appearing in this manual indicates a flash memory device and digital audio players can be recognized as mass-storage.

● About file system

The file system should be the one of the following.

- FAT16
- FAT32

NOTE

- When the USB device is connected to this unit, it can be charged through the USB cable.
- Install the USB device in the place where it will not affect safe driving.
- You cannot connect a USB device via a USB hub and Multi Card Reader.
- Take backups of the audio files used with this unit. The files can be erased depending on the operating conditions of the USB device. We shall have no compensation for any damage arising from any erased data.
- No USB device comes with this unit. You need to purchase a commercially available USB device.
- When connecting the USB device, usage of the CA-U1EX (option) is recommended. (However, maximum supply current of CA-U1EX is 500mA.) Normal playback is not guaranteed when a cable other than the USB compatible cable is used.

Usable SD card and microSD card

(DNN9250DAB/ DNN6250DAB)

The unit is capable of playback of SD/SDHC memory cards (DNN9250DAB) or microSD/microSDHC memory cards (DNN6250DAB) complying with the SD or SDHC standard.

A special adapter is required to use a miniSD card, miniSDHC card, microSD card or microSDHC card.

The MultiMedia Card (MMC) cannot be used.

Status Bar Indicator Items

Shown below is a list of indicators displayed on the status bar in the screen.
Current status of this unit is displayed on the bar.



Status bar

● General

ATT

The attenuator is active.

DUAL

The dual zone function is on.

TEL

Indicates the connection state of the Bluetooth hands-free unit.

- White: Connected
- Orange: Not connected

LOUD

The loudness control function is on.

● DVD/CD

FO-REP

Folder repeat function is on.

IN

A disc is inserted.

- White: A Disc is inside the unit.
- Orange: Error at the disc player

VIDEO

Identifies the video file.

MUSIC

Identifies the music file.

RDM

The random function is on.

REP

The repeat function is on.

C-REP

The chapter repeat function is on.

T-REP

The title repeat function is on.

● VCD

1chLL/2chLL

Identifies the left audio output of channel 1 or 2.

1chLR/2chLR

Identifies the monaural audio output of channel 1 or 2.

1chRR/2chRR

Identifies the right audio output of channel 1 or 2.

1chST/2chST

Identifies the stereo audio output of channel 1 or 2.

LL

Identifies the left audio output.

LR

Identifies the monaural audio output.

RR

Identifies the right audio output.

STEREO

Identifies the stereo audio output.

PBC

The PBC function is on.

SVCD

Identifies the Super Video CD.

VER1

The VCD version is 1.

VER2

The VCD version is 2.

REP

The repeat function is on.

● USB SD

FO-REP

The folder repeat function is on.

VIDEO

Identifies the video file.

MUSIC

Identifies the music file.

RDM

The random function is on.

REP

The repeat function is on.

PLST

The play list mode is selected now.

● iPod

MUSIC

Identifies the music file.

VIDEO

Identifies the video file.

RDM

The random function is on.

A-RDM

The album random function is on.

REP

The repeat function is on.

● Digital Radio

Digital Radio

Digital Radio is being received.

RDS

Radio Data System is being received.

AUTO1

Seek mode is set to AUTO1.

AUTO2

Seek mode is set to AUTO2.

MANUAL

Seek mode is set to MANUAL.

MC

Receiving service is displayed.

- White: Primary Component is received.
- Orange: Secondary Component is received.

● Tuner

AUTO1

Seek mode is set to AUTO1.

AUTO2

Seek mode is set to AUTO2.

MONO

The forced monaural function is on.

AF

The AF search function is on.

EON

The Radio Data System station is sending EON.

Lo.S

The Local Seek function is on.

NEWS

News bulletin interruption is in progress.

RDS

Indicates the state of the Radio Data System station when the AF function is on.

- White: Radio Data System is being received.
- Orange: Radio Data System is not being received.

MANUAL

Seek mode is set to MANUAL.

ST

A stereo broadcast is being received.

TI

Indicates the reception state of traffic information.

- White: TP is being received.
- Orange: TP is not being received.

Region Codes in the World

The DVD players are given a region code according to the country or area it is marketed, as shown in the following map.

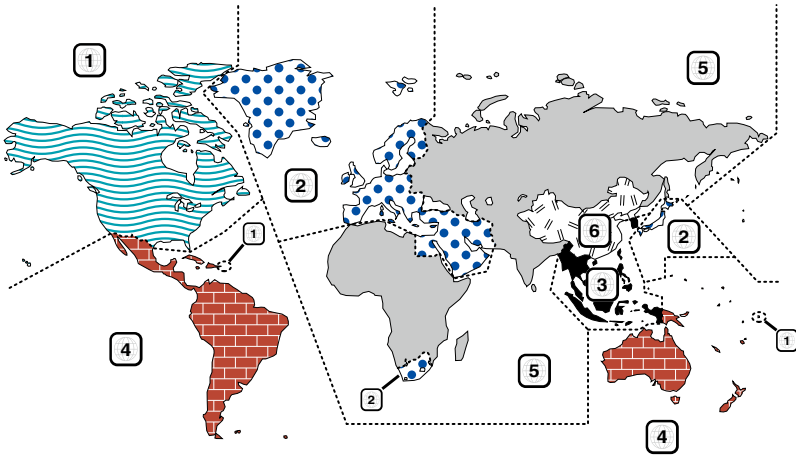

● DVD disc marks



Indicates a region number. The discs with this mark can be played with any DVD player.



Indicates the number of audio languages recorded. Up to 8 languages can be recorded in a movie. You can select a favorite language.



Indicates the number of subtitled languages recorded. Up to 32 languages can be recorded.



If a DVD disc has scenes shot from multiple angles, you can select a favorite angle.

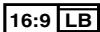

Indicates the type of screen for the image. The left mark indicates that a wide image picture (16:9) is displayed on a standard TV set screen (4:3) with a black band at both the top and bottom of the screen (letter box).

● Operation regulatory marks

With this DVD, some functions of this unit such as the play function may be restricted depending on the location where the DVD is playing. In this case, the following marks will appear on the screen. For more information, refer to the disc manual.



● Discs with limited period of use

Do not leave discs with a limited period of use in this unit. If you load an already expired disc, you may not be able to remove it from this unit.

DVD Language Codes

Code	Language
aa	Afar
ab	Abkhazian
af	Afrikaans
am	Amharic
ar	Arabic
as	Assamese
ay	Aymara
az	Azerbaijani
ba	Bashkir
be	Byelorussian
bg	Bulgarian
bh	Bihari
bi	Bislama
bn	Bengali, Bangla
bo	Tibetan
br	Breton
ca	Catalan
co	Corsican
cs	Czech
cy	Welsh
da	Danish
de	German
dz	Bhutani
el	Greek
en	English
eo	Esperanto
es	Spanish
et	Estonian
eu	Basque
fa	Persian
fi	Finnish
fj	Fiji
fo	Faroese
fr	French
fy	Frisian
ga	Irish
gd	Scots Gaelic
gl	Galician
gn	Guarani
gu	Gujarati
ha	Hausa
he	Hebrew
hi	Hindi
hr	Croatian
hu	Hungarian
hy	Armenian

Code	Language
ia	Interlingua
ie	Interlingue
ik	Inupiak
id	Indonesian
is	Icelandic
it	Italian
ja	Japanese
jav	Javanese
ka	Georgian
kk	Kazakh
kl	Greenlandic
km	Cambodian
kn	Kannada
ko	Korean
ks	Kashmiri
ku	Kurdish
ky	Kirghiz
la	Latin
lb	Luxembourgish
ln	Lingala
lo	Laotian
lt	Lithuanian
lv	Latvian, Lettish
mg	Malagasy
mi	Maori
mk	Macedonian
ml	Malayalam
mn	Mongolian
mo	Moldavian
mr	Marathi
ms	Malay
mt	Maltese
my	Burmese
na	Nauru
ne	Nepali
nl	Dutch
no	Norwegian
oc	Occitan
om	(Afan) Oromo
or	Oriya
pa	Punjabi
pl	Polish
ps	Pashto, Pushto
pt	Portuguese
qu	Quechua
rm	Rhaeto-Romance

Code	Language
rn	Kirundi
ro	Romanian
ru	Russian
rw	Kinyarwanda
sa	Sanskrit
sd	Sindhi
sg	Sangho
sh	Serbo-Croatian
si	Singhalese
sk	Slovak
sl	Slovenian
sm	Samoaan
sn	Shona
so	Somali
sq	Albanian
sr	Serbian
ss	Siswati
st	Sesotho
su	Sundanese
sv	Swedish
sw	Swahili
ta	Tamil
te	Telugu
tg	Tajik
th	Thai
ti	Tigrinya
tk	Turkmen
tl	Tagalog
tn	Setswana
to	Tongan
tr	Turkish
ts	Tsonga
tt	Tatar
tw	Twí
uk	Ukrainian
ur	Urdu
uz	Uzbek
vi	Vietnamese
vo	Volapuk
wo	Wolof
xh	Xhosa
yo	Yoruba
zh	Chinese
zu	Zulu

Specifications

● Monitor section

Picture Size

- DNN9250DAB/ DNR8025BT
- : 6.95 inches (diagonal) wide
- : 156.6 mm (W) x 81.6 mm (H)
- DNN6250DAB
- : 6.1 inches (diagonal) wide
- : 136.2 mm (W) x 72.0 mm (H)

Display System

- : Transparent TN LCD panel

Drive System

- : TFT active matrix system

Number of Pixels

- : 1,152,000 (800H x 480V x RGB)

Effective Pixels

- : 99.99 %

Pixel Arrangement

- : RGB striped arrangement

Back Lighting

- : LED

● DVD player section

D/A Converter

- : 24 bit

Audio Decoder

- : Linear PCM/Dolby Digital/MP3/WMA/AAC

Video Decoder

- : MPEG1/ MPEG2/ DivX

Wow & Flutter

- : Below Measurable Limit

Frequency Response

- 96 kHz : 20 – 20,000 Hz
- 48 kHz : 20 – 20,000 Hz
- 44.1 kHz : 20 – 20,000 Hz

Total Harmonic Distortion

- DNN9250DAB: 0.008 % (1 kHz)
- DNN6250DAB/ DNR8025BT: 0.01 % (1 kHz)

S/N Ratio (dB)

- : 90 dB (DVD-Video 96 kHz)

Dynamic Range

- : 91 dB (DVD-Video 96 kHz)

Disc Format

- : DVD-Video/ VIDEO-CD/ CD-DA

Sampling Frequency

- : 44.1/48/96 kHz

Quantifying Bit Number

- : 16/20/24 bit

● USB interface section

USB Standard

- : USB 2.0 Full/ High speed

File System

- : FAT 16/ 32

Maximum Power Supply Current

DNN9250DAB

- iPod/iPhone: DC 5 V $\overline{\text{---}}$ 1 A
- USB: DC 5 V $\overline{\text{---}}$ 500 mA

DNN6250DAB/ DNR8025BT

- : DC 5 V $\overline{\text{---}}$ 1 A

D/A Converter

- : 24 Bit

Video Decoder

- : MPEG1/MPEG2/MPEG4/WMV/H.264

Audio Decoder

- : MP3/ WMA/ AAC/ WAV/ FLAC

● SD

SD Standard

- DNN9250DAB: SD/ SD-HC
- DNN6250DAB: microSD/ microSD-HC

Compatible File System

- : FAT 16/32

Capacity

- : Maximum 32G Byte

Data Transfer Rate

- : Maximum 24MB/sec

Video Decoder

- : MPEG1/MPEG2/MPEG4/WMV/H.264

Audio Decoder

- : MP3/ WMA/ AAC/ WAV/ FLAC

● **Network section**

uPnp

: Media Controller/Media Server/Media player/Media
Renderer

Video Decoder

: MPEG1/MPEG2/MPEG4/WMV/H.264

Audio Decoder

: MP3/WMA/ AAC/WAV/FLAC

● **Wi-Fi section**

IEEE Standard

: 802.11b/g/n

Security Support

: 64/128bit WEP / WPA & WPA2

Frequency Range

: 2.401 – 2.483 GHz

Transfer rates (MAX)

QAU0569: 802.11n(130 Mbps) / 802.11g(54 Mbps) /
802.11b(11 Mbps)

W02-5617: 802.11n(150 Mbps) / 802.11g(54 Mbps) /
802.11b(11 Mbps)

Output Power

QAU0569: DSSS: 15 – 18dBm,
OFDM (11g): 13 – 17dBm,
OFDM (11n): 11 – 15dBm

W02-5617: 16 – 18dBm (CCK),
13 – 15dBm (OFDM)

● **Bluetooth section**

Technology

: Bluetooth Ver3.0+EDR

Frequency

: 2.402 – 2.480 GHz

Output Power

: +4dBm (MAX), 0dBm (AVE), Power Class2

Maximum Communication Range

: Line of sight approx. 10m (32.8 ft)

Audio Codec

DNN9250DAB: SBC/ AAC/ MP3/ aptX
DNN6250DAB/ DNR8025BT: SBC/ AAC/ MP3

Profile

- HFP (V1.6) (Hands Free Profile)
- SPP (Serial Port Profile)
- SDP (Service Discovery Profile)
- A2DP (Advanced Audio Distribution Profile)
- AVRCP (Audio/Video Remote Control Profile)
- PBAP (Phonebook Access Profile)
- GAP (Generic Access Profile)
- Multi Profile support

● **HDMI/ MHL section**

HDMI

: HDMI Type-A

MHL Supported Version

: MHL 2

MHL Maximum Power Supply Current

: DC 5 V \pm 900 mA

● **DSP section**

Graphics equalizer

DNN9250DAB/DNR8025BT

Band: 13 Band
Frequency (BAND1 – 13)
: 62.5/100/160/250/400/630/1k/1.6k/2.5k/4k/6.3k/
10k/16k Hz

DNN6250DAB

Band: 7 Band
Frequency (BAND1 – 7)
: 62.5/160/400/1k/2.5k/6.3k/16k Hz

Gain

: -9/-8/-7/-6/-5/-4/-3/-2/-1/0/1/2/3/4/5/6/7/8/9 dB

X'over

DNN9250DAB/DNR8025BT

Front/ Rear High pass filter

Frequency: Through, 30/ 40/ 50/ 60/ 70/ 80/ 90/ 100/
120/ 150 / 180/ 220/ 250 Hz

Slope: -6/-12/-18/-24 dB/Oct.

Subwoofer Low pass filter

Frequency: 30/ 40/ 50/ 60/ 70/ 80/ 90/ 100/ 120/
150/ 180/ 220/ 250 Hz, Through

Slope: -6/-12/-18/-24 dB/Oct.

DNN6250DAB

Front/ Rear High pass filter

Frequency: Through, 50/ 60/ 80/ 100/ 120/ 150 /
180/ 220 Hz

Slope: -6/-12/-18/-24 dB/Oct.

Subwoofer Low pass filter

Frequency: 50/ 60/ 80/ 100/ 120 Hz, Through

Slope: -6/-12/-18/-24 dB/Oct.

Position

Front / Rear /Subwoofer Delay

: 0 – 610 cm (2 cm Step)

Gain

: -8 – 0 dB

Subwoofer level

: -50 – +10 dB

● FM tuner section

Frequency Range (step)

: 87.5 MHz – 108.0 MHz (50 kHz)

Usable Sensitivity (S/N : 26 dB)

: 0.63 μ V/75 Ω

Quieting Sensitivity (S/N : 46 dB)

: 15.2 dBf (1.6 μ V/75 Ω)

Frequency Response (\pm 3.0 dB)

: 30 Hz – 15 kHz

S/N Ratio (dB)

: 75 dB (MONO)

Selectivity (\pm 400 kHz)

: Over 80 dB

Stereo Separation

: 45 dB (1 kHz)

● AM tuner section

Frequency Range (step)

LW : 153 – 279 kHz (9 kHz)

MW : 531 – 1611 kHz (9 kHz)

Usable Sensitivity

MW : 25 μ V

LW : 45 μ V

● DAB section

(DNN9250DAB/DNN6250DAB)

Frequency Range

L-BAND: 1452.960 – 1490.624 (MHz)

BAND III: 174.928 – 239.200 (MHz)

Sensitivity

: -100 dBm

S/N Ratio (dB)

: 90 dB

● Digital Antenna Connector section

(DNN9250DAB/DNN6250DAB)

Connector type

: SMB

Output Voltage (11 – 16V)

: 14.4 V

Maximum Current

: < 100 mA

● Video section

Color System of External Video Input

: NTSC/PAL

External Video Input Level (RCA jacks)

: 1 Vp-p/ 75 Ω

External Audio Max Input Level (RCA jacks)

: 2 V/ 25 k Ω

Video Input Level (RCA jacks)

: 1 Vp-p/ 75 Ω

Video Output Level (RCA jacks)

: 1 Vp-p/ 75 Ω

Audio Output Level (Mini jack)

: 1.2 V/ 10 k Ω

● Audio section

Maximum Power (Front & Rear)

: 50 W x 4

Full Bandwidth Power (Front & Rear) (PWR DIN45324,

+B = 14.4 V)

: 30 W x 4

Preout Level (V)

DNN9250DAB/DNR8025BT : 5 V/ 10 k Ω

DNN6250DAB : 2 V/ 10 k Ω

Preout Impedance

DNN9250DAB/DNR8025BT : \leq 250 Ω

DNN6250DAB : \leq 600 Ω

Speaker Impedance

: 4 – 8 Ω

● **Navigation section**
(DNN9250DAB/DNN6250DAB)

Receiver

: High-sensitivity GPS receiver

Reception Frequency

: 1575.42 MHz (C/A code)

Acquisition Times

Cold : 29 seconds (typ)

(All satellites at -130 dBm Without aiding)

Update Rate

: 1/second, continuous

Accuracy

Position: <2.5 meters, CEP, at -130 dBm

Velocity: 0.1 meter/sec RMS

Position Method

: GPS

Antenna

: External GPS antenna

● **General**

Operating Voltage

: 14.4 V (10.5 – 16 V allowable)

Maximum Current Consumption

: 10 A

Installation Dimensions (W × H × D)

DNN9250DAB/ DNR8025BT: 181.7 × 112.3 × 163 mm

DNN6250DAB: 181.7 × 112.3 × 160.3 mm

Operational Temperature Range

: -10 °C – +60 °C

Weight

DNN9250DAB: 2.7 kg

DNN6250DAB: 2.0 kg

DNR8025BT: 2.6 kg

NOTE

- Although the effective pixels for the liquid crystal panel is given as 99.99% or more, 0.01% of pixels may not light or may light incorrectly.

Specifications subject to change without notice.

Trademarks

- The Bluetooth word mark and logos are owned by the Bluetooth SIG, Inc. and any use of such marks by JVC KENWOOD Corporation is under license. Other trademarks and trade names are those of their respective owners.



- The “AAC” logo is a trademark of Dolby Laboratories.



- Microsoft and Windows Media are either registered trademarks or trademarks of Microsoft Corporation in the United States and/or other countries.



- “Made for iPod” and “Made for iPhone” mean that an electronic accessory has been designed to connect specifically to iPod or iPhone, respectively, and has been certified by the developer to meet Apple performance standards. Apple is not responsible for the operation of this device or its compliance with safety and regulatory standards. Please note that the use of this accessory with iPod or iPhone may affect wireless performance.



- iPhone, iPod, iPod classic, iPod nano, and iPod touch are trademarks of Apple Inc., registered in the U.S. and other countries. Lightning is a trademark of Apple Inc.



-  is a trademark of DVD Format/Logo Licensing Corporation registered in the U.S., Japan and other countries.



- This item incorporates copy protection technology that is protected by U.S. patents and other intellectual property rights of Rovi Corporation. Reverse engineering and disassembly are prohibited.
- QR Code® is registered trademarks of DENSO WAVE INCORPORATED in JAPAN and other countries.

- Manufactured under license from Dolby Laboratories. Dolby and the double-D symbol are trademarks of Dolby Laboratories.



- DAB+



- Wi-Fi is a registered trademark of the Wi-Fi Alliance.



- Google, the Google logo, Android, Gmail, and YouTube are trademarks of Google Inc.
- SDHC Logo is a trademark of SD-3C, LLC.



- microSDHC Logo is a trademark of SD-3C, LLC.



- Twitter is a registered trademark of Twitter, Inc.
- Facebook® is a registered trademark of Facebook Inc.
- INRIX is a registered trademark of INRIX, Inc.
- Nuance is a registered trademark of Nuance Communications, Inc.
- "aupeo" is a trade mark of Aupeo Ltd.
- Dropbox is a trademark of Dropbox Inc.
- The terms HDMI and HDMI High-Definition Multimedia Interface, and the HDMI logo are trademarks or registered trademarks of HDMI Licensing LLC in the United States and other countries.



- MHL and the MHL logo are a trademark or registered trademark of MHL, LLC.
- Incorporates MHL 2



- ABOUT DIVX VIDEO: DivX® is a digital video format created by DivX, LLC, a subsidiary of Rovi Corporation. This is an official DivX Certified® device that plays DivX video. Visit divx.com for more information and software tools to convert your files into DivX videos.
- ABOUT DIVX VIDEO-ON-DEMAND: This DivX Certified® device must be registered in order to play purchased DivX Video-on-Demand (VOD) movies. To obtain your registration code, locate the DivX VOD section in your device setup menu. Go to vod.divx.com for more information on how to complete your registration.
- DivX®, DivX Certified® and associated logos are trademarks of Rovi Corporation or its subsidiaries and are used under license.



- The aptX® software is copyright CSR plc or its group companies. All rights reserved. The aptX® mark and the aptX logo are trademarks of CSR plc or one of its group companies and may be registered in one or more jurisdictions.



- AVC
THIS PRODUCT IS LICENSED UNDER THE AVC PATENT PORTFOLIO LICENSE FOR THE PERSONAL USE OF A CONSUMER OR OTHER USES IN WHICH IT DOES NOT RECEIVE REMUNERATION TO (i) ENCODE VIDEO IN COMPLIANCE WITH THE AVC STANDARD ("AVC VIDEO") AND/OR (ii) DECODE AVC VIDEO THAT WAS ENCODED BY A CONSUMER ENGAGED IN A PERSONAL ACTIVITY AND/OR WAS OBTAINED FROM A VIDEO PROVIDER LICENSED TO PROVIDE AVC VIDEO. NO LICENSE IS GRANTED OR SHALL BE IMPLIED FOR ANY OTHER USE. ADDITIONAL INFORMATION MAY BE OBTAINED FROM MPEG LA, L.L.C. SEE [HTTP://WWW.MPEGLA.COM](http://WWW.MPEGLA.COM)
- MPEG-4 Visual
THIS PRODUCT IS LICENSED UNDER THE MPEG-4 VISUAL PATENT PORTFOLIO LICENSE FOR THE PERSONAL AND NON-COMMERCIAL USE OF A CONSUMER FOR (i) ENCODING VIDEO IN COMPLIANCE WITH THE MPEG-4 VISUAL STANDARD ("MPEG-4 VIDEO") AND/OR (ii) DECODING MPEG-4 VIDEO THAT WAS ENCODED BY A CONSUMER ENGAGED IN A PERSONAL AND NON-COMMERCIAL ACTIVITY AND/OR WAS OBTAINED FROM A VIDEO PROVIDER LICENSED BY MPEG LA TO PROVIDE MPEG-4 VIDEO. NO LICENSE IS GRANTED OR SHALL BE IMPLIED FOR ANY OTHER USE. ADDITIONAL INFORMATION INCLUDING THAT RELATING TO PROMOTIONAL, INTERNAL AND COMMERCIAL USES AND LICENSING MAY BE OBTAINED FROM MPEG LA, LLC. SEE [HTTP://WWW.MPEGLA.COM](http://WWW.MPEGLA.COM).

• libFLAC

Copyright (C) 2000,2001,2002,2003,2004,2005,2006,2007,2008,2009 Josh Coalson

Redistribution and use in source and binary forms, with or without modification, are permitted provided that the following conditions are met:

- Redistributions of source code must retain the above copyright notice, this list of conditions and the following disclaimer.
- Redistributions in binary form must reproduce the above copyright notice, this list of conditions and the following disclaimer in the documentation and/or other materials provided with the distribution.
- Neither the name of the Xiph.org Foundation nor the names of its contributors may be used to endorse or promote products derived from this software without specific prior written permission.

THIS SOFTWARE IS PROVIDED BY THE COPYRIGHT HOLDERS AND CONTRIBUTORS "AS IS" AND ANY EXPRESS OR IMPLIED WARRANTIES, INCLUDING, BUT NOT LIMITED TO, THE IMPLIED WARRANTIES OF MERCHANTABILITY AND FITNESS FOR A PARTICULAR PURPOSE ARE DISCLAIMED. IN NO EVENT SHALL THE FOUNDATION OR CONTRIBUTORS BE LIABLE FOR ANY DIRECT, INDIRECT, INCIDENTAL, SPECIAL, EXEMPLARY, OR CONSEQUENTIAL DAMAGES (INCLUDING, BUT NOT LIMITED TO, PROCUREMENT OF SUBSTITUTE GOODS OR SERVICES; LOSS OF USE, DATA, OR PROFITS; OR BUSINESS INTERRUPTION) HOWEVER CAUSED AND ON ANY THEORY OF LIABILITY, WHETHER IN CONTRACT, STRICT LIABILITY, OR TORT (INCLUDING NEGLIGENCE OR OTHERWISE) ARISING IN ANY WAY OUT OF THE USE OF THIS SOFTWARE, EVEN IF ADVISED OF THE POSSIBILITY OF SUCH DAMAGE.

Safety precaution

● The marking of products using lasers

**CLASS 1
LASER PRODUCT**

The label is attached to the chassis/case and says that the component uses laser beams that have been classified as Class 1. It means that the unit is utilizing laser beams that are of a weaker class. There is no danger of hazardous radiation outside the unit.

● Information on Disposal of Old Electrical and Electronic Equipment and Batteries (applicable for EU countries that have adopted separate waste collection systems)

Products and batteries with the symbol (crossed-out wheeled bin) cannot be disposed as household waste. Old electrical and electronic equipment and batteries should be recycled at a facility capable of handling these items and their waste byproducts.

Contact your local authority for details in locating a recycle facility nearest to you.

Proper recycling and waste disposal will help conserve resources whilst preventing detrimental effects on our health and the environment.

Notice: The sign "Pb" below the symbol for batteries indicates that this battery contains lead.

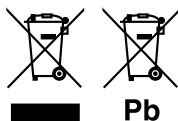

● מידע בדבר השלכה לאשפה של ציוד חשמלי ואלקטרוני ישן וכן סוללות (רלוונטי למדינות שמשמשות במערכת איסוף אשפה מופרדת).

לא ניתן להשליך מוצרים וסוללות עם הסימון (פח אשפה עם X עליו) כאשפה ביתית רגילה.

יש למחזר ציוד חשמלי ואלקטרוני ישן וכן סוללות במתקן המסוגל לטפל בפריטים כאלה ובתוצרי הלואי שלהם.

צרו קשר עם הרשות המקומית לקבלת פרטים אודות מתקן המיחזור הקרוב אליכם. מיחזור והשלכה לאשפה נאותים יעזרו לשמר משאבים ולמנוע השפעות שליליות על בריאותנו ועל הסביבה.

שימו לב: הסימון Pb שמתחת לסימון עבור סוללות מצוין שהסוללה מכילה עופרת.

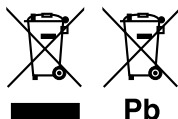

● About QAU0569, W02-5617 (USB Wi-Fi® adapter)

The Wi-Fi Adapter is attached to this unit when shipped from the factory. When the adapter is removed, store it in a safe place.



Declaration of Conformity with regard to the EMC Directive 2004/108/EC
Declaration of Conformity with regard to the R&TTE Directive 1999/5/EC
Declaration of Conformity with regard to the RoHS Directive 2011/65/EU

Manufacturer:

JVC KENWOOD Corporation

3-12, Moriyacho, Kanagawa-ku, Yokohama-shi, Kanagawa 221-0022, JAPAN

EU Representative:

JVCKENWOOD NEDERLAND B.V.

Amsterdamseweg 37, 1422 AC UITHOORN, The Netherlands

English

Hereby, JVC KENWOOD declares that this unit DNN9250DAB/ DNN6250DAB/ DNR8025BT is in compliance with the essential requirements and other relevant provisions of Directive 1999/5/EC.

Français

Par la présente JVC KENWOOD déclare que l'appareil DNN9250DAB/ DNN6250DAB/ DNR8025BT est conforme aux exigences essentielles et aux autres dispositions pertinentes de la directive 1999/5/CE.

Par la présente, JVC KENWOOD déclare que ce DNN9250DAB/ DNN6250DAB/ DNR8025BT est conforme aux exigences essentielles et aux autres dispositions de la directive 1999/5/CE qui lui sont applicables.

Deutsch

Hiermit erklärt JVC KENWOOD, dass sich dieser DNN9250DAB/ DNN6250DAB/ DNR8025BT in Übereinstimmung mit den grundlegenden Anforderungen und den anderen relevanten Vorschriften der Richtlinie 1999/5/EG befindet. (BMW)

Hiermit erklärt JVC KENWOOD die Übereinstimmung des Gerätes DNN9250DAB/ DNN6250DAB/ DNR8025BT mit den grundlegenden Anforderungen und den anderen relevanten Festlegungen der Richtlinie 1999/5/EG. (Wien)

Nederlands

Hierbij verklaart JVC KENWOOD dat het toestel DNN9250DAB/ DNN6250DAB/ DNR8025BT in overeenstemming is met de essentiële eisen en de andere relevante bepalingen van richtlijn 1999/5/EG.

Bij deze verklaart JVC KENWOOD dat deze DNN9250DAB/ DNN6250DAB/ DNR8025BT voldoet aan de essentiële eisen en aan de overige relevante bepalingen van Richtlijn 1999/5/EC.

Italiano

Con la presente JVC KENWOOD dichiara che questo DNN9250DAB/ DNN6250DAB/ DNR8025BT è conforme ai requisiti essenziali ed alle altre disposizioni pertinenti stabilite dalla direttiva 1999/5/CE.

Español

Por medio de la presente JVC KENWOOD declara que el DNN9250DAB/ DNN6250DAB/ DNR8025BT cumple con los requisitos esenciales y cualesquiera otras disposiciones aplicables o exigibles de la Directiva 1999/5/CE.

Português

JVC KENWOOD declara que este DNN9250DAB/ DNN6250DAB/ DNR8025BT está conforme com os requisitos essenciais e outras disposições da Directiva 1999/5/CE.

Polska

JVC KENWOOD niniejszym oświadcza, że DNN9250DAB/ DNN6250DAB/ DNR8025BT spełnia zasadnicze wymagania oraz inne istotne postanowienia dyrektywy 1999/5/EC.

Česky

JVC KENWOOD tímto prohlašuje, že DNN9250DAB/ DNN6250DAB/ DNR8025BT je ve shodě se základními požadavky a s dalšími příslušnými ustanoveními Nařízení vlády č. 426/2000 Sb.

Magyar

Alulírott, JVC KENWOOD, kijelenti, hogy a jelen DNN9250DAB/ DNN6250DAB/ DNR8025BT megfelel az 1999/5/EC irányelvben meghatározott alapvető követelményeknek és egyéb vonatkozó előírásoknak.

Svenska

Härmed intygar JVC KENWOOD att denna DNN9250DAB/ DNN6250DAB/ DNR8025BT står i överensstämmelse med de väsentliga

egenskapskrav och övriga relevanta bestämmelser som framgår av direktiv 1999/5/EG.

Suomi

JVC KENWOOD vakuuttaa täten että DNN9250DAB/ DNN6250DAB/ DNR8025BT tyyppinen laite on direktiivin 1999/5/EY oleellisten vaatimusten ja sitä koskevien direktiivin muiden ehtojen mukainen.

Slovensko

S tým JVC KENWOOD izjavlja, da je ta DNN9250DAB/ DNN6250DAB/ DNR8025BT v skladu z osnovnimi zahtevami in ostalimi ustreznimi predpisi Direktive 1999/5/EC.

Slovensky

Spoločnosť JVC KENWOOD týmto vyhlasuje, že DNN9250DAB/ DNN6250DAB/ DNR8025BT spĺňa základné požiadavky a ďalšie príslušné ustanovenia Direktívy 1999/5/EC.

Dansk

Undertegnede JVC KENWOOD erklærer herved, at følgende udstyr DNN9250DAB/ DNN6250DAB/ DNR8025BT overholder de væsentlige krav og øvrige relevante krav i direktiv 1999/5/EF.

Ελληνικά

ΜΕ ΤΗΝ ΠΑΡΟΥΣΑ JVC KENWOOD ΔΗΛΩΝΕΙ ΟΤΙ Ο DNN9250DAB/ DNN6250DAB/ DNR8025BT ΣΥΜΜΟΡΦΟΝΕΙΤΑΙ ΠΡΟΣ ΤΙΣ ΟΥΣΙΩΔΕΙΣ ΑΠΑΙΤΗΣΕΙΣ ΚΑΙ ΤΙΣ ΛΟΙΠΕΣ ΣΧΕΤΙΚΕΣ ΔΙΑΤΑΞΕΙΣ ΤΗΣ ΟΔΗΓΙΑΣ 1999/5/ΕΚ.

Eesti

Sellela kinnitab JVC KENWOOD, et see DNN9250DAB/ DNN6250DAB/ DNR8025BT vastab direktiivi 1999/5/EC põhilistele nõudmistele ja muudele asjakohastele määrustele.

Latviešu

Ar šo, JVC KENWOOD, apstiprina, ka DNN9250DAB/ DNN6250DAB/ DNR8025BT atbilst Direktīvas 1999/5/EK galvenajām prasībām un citiem tās nosacījumiem.

Lietuviškai

Šiuo, JVC KENWOOD, pareiškia, kad šis DNN9250DAB/ DNN6250DAB/ DNR8025BT atitinka pagrindinius Direktyvos 1999/5/EB reikalavimus ir kitas svarbias nuostatas.

Malti

Hawnhekk, JVC KENWOOD, jiddikjara li dan DNN9250DAB/ DNN6250DAB/ DNR8025BT jikkonforma mal-htigijiet essenzjali u ma provvedimenti oħrajn relevanti li hemm fid-Direttiva 1999/5/EC.

Українська

Компанія JVC KENWOOD заявляє, що цей виріб DNN9250DAB/ DNN6250DAB/ DNR8025BT відповідає ключовим вимогам та іншим пов'язаним положенням Директиви 1999/5/EC.

Norsk

JVC KENWOOD erklærer herved at enheten DNN9250DAB/ DNN6250DAB/ DNR8025BT oppfyller grunnleggende krav og andre bestemmelser i direktiv 1999/5/EF.

Türkçe

Bu vesileyle JVC KENWOOD, DNN9250DAB/ DNN6250DAB/ DNR8025BT ünitesinin, 1999/5/EC Direktifinin başlıca gereksinimleri ve diğer ilgili hükümleri ile uyumlu olduğunu beyan eder.

Croatia

Ovim putem tvrtka JVC KENWOOD izjavljuje da je ovaj uređaj DNN9250DAB/ DNN6250DAB/ DNR8025BT sukladan osnovnim zahtjevima i drugim važnim odredbama Direktive 1999/5/EC.



KENWOOD

DNN991HD

DNN9250DAB

Voice Command Table

JVCKENWOOD Corporation

14DNN_IM383_VoiceCommand_en_00 (K/E)

© 2014 JVC KENWOOD Corporation

General operation

Screen	Operation	Voice Command			
		US English	UK English	French	German
Any screen	Canceling the voice control mode	Cancel	Cancel	Annuler	Abbr.
	Displays the Top Menu screen	Top menu	Top menu	Menu sup	Hauptmenü
	Switches to DAB source *1	DAB	DAB	DAB	DAB
	Switches to Wireless Link source	Wireless Link	Wireless Link	Wireless Link	Wireless Link
	Switches to DVD source	DVD	DVD	DVD	DVD
	Switches to HD Radio source *2	HD Radio	HD Radio	Radio HD	HD Radio
	Switches to iPod source	iPod	iPod	iPod	iPod
	Switches to Bluetooth Audio source	Bluetooth audio	Bluetooth audio	Audio Bluetooth	Bluetooth audio
	Switches to SiriusXM source *2	SiriusXM	SiriusXM	SiriusXM	SiriusXM
	Switches to STANDBY source	Standby	Standby	Veille	Standby
	Switches to Cloud Storage source	Storage	Storage	Storage	Storage
	Switches to Tuner source *1	Tuner	Tuner	Tuner	Tuner
	Switches to USB source	USB	USB	USB	USB
	Switches to Pandora source *2	Pandora	Pandora	Pandora	Pandora
	Switches to AUPEO! source	AUPEO!	AUPEO!	AUPEO!	AUPEO!
	Switches to iHeart Radio source *2	iHeart Radio	iHeart Radio	iHeart Radio	iHeart Radio
	Switches to Streaming Video source	Streaming Video	Streaming Video	Streaming Video	Streaming Video
	Switches to APPS source	Apps	Apps	Apps	Apps
	Switches to HDMI source	HDMI	HDMI	HDMI	HDMI
		MHL	MHL	MHL	MHL
	Switches the AV OUT source	AV out	AV out	sortie AV	AV out
	Displays Hands Free screen	Hands free	Hands free	Mains libres	Telefon
	Switches to Mixed Media Search	Media Search	Media Search	Media Search	Media Search
	Switches to Phone Search	Phone Search	Phone Search	Phone Search	Phone Search
	Displays OEM Features screen *2	OEM	OEM	OEM	OEM
	Displays the view from the Front View camera	Front camera	Front camera	Caméra avant	Frontkamera
	Displays the view from the Rear View camera	Rear camera	Rear camera	Caméra arrière	Rückfahrkamera
	Displays Current Source Control screen	Control screen	Control screen	Écran de commande	Steuerbildschirm
	Searches the previous station/channel.	Seek down	Seek down	Rechercher vers le bas	Suche abwärts
	Searches the next station/channel.	Seek up	Seek up	Rechercher vers le haut	Suche aufwärts
	Searches the previous track/file.	Track down	Track down	Piste précédente	Titel abwärts
	Searches the next track/file.	Track up	Track up	Piste suivante	Titel aufwärts
	Switches to RSS Application	RSS	RSS	RSS	RSS
	Switches to Weather Application	Weather	Weather	Météo	Wetter
Switches to Facebook in SNS Application	Facebook	Facebook	Facebook	Facebook	
Create a Facebook Status in SNS Application	Status	Status	Statut	Status	
Switches to Twitter in SNS Application	Twitter	Twitter	Twitter	Twitter	
Create a Tweet in SNS Application	Tweet	Tweet	Tweet	Twitter-Nachricht	
Switches to Gmail in SNS Application	Mail	Mail	Message	Email	
Posting the current place.	I'm Here	I'm Here	Je suis ici	Mein Standort	
Posting the information about the song you are listening to.	I'm Listening	I'm Listening	J'écoute	Ich höre gerade	
Switches to Schedule Application	Schedule	Schedule	Agenda	Kalender	
Displays the Current Location Information	View Map	View Map	View Map	View Map	

Dutch	Italian	Spanish
Terug	Annulla	Cancelar
Hoofdmenu	Menu princ.	Menú superior
DAB	DAB	DAB
Wireless Link	Wireless Link	Wireless Link
DVD	DVD	DVD
HD Radio	HD Radio	HD Radio
iPod	iPod	iPod
Bluetooth audio	Audio Bluetooth	Audio Bluetooth
SiriusXM	SiriusXM	SiriusXM
Stand by	Attesa	En espera
Storage	Storage	Storage
Tuner	Radio	Sintonizador
USB	USB	USB
Pandora	Pandora	Pandora
AUPEO!	AUPEO!	AUPEO!
iHeart Radio	iHeart Radio	iHeart Radio
Streaming Video	Streaming Video	Streaming Video
Apps	Apps	Apps
HDMI	HDMI	HDMI
MHL	MHL	MHL
AV uit	AV out	salida AV
Handsfree	Vivavoce	Manos libres
Media Search	Media Search	Media Search
Phone Search	Phone Search	Phone Search
OEM	OEM	OEM
Vooruitzicht camera	Telecamera frontale	Cámara delantera
Camera achter	Retrocamera	Cámara trasera
Scherm besturen	Scherm. di controllo	Pantalla de control
Omlaag zoeken	Ricerca giù	Buscar anterior
Omhoog zoeken	Ricerca su	Buscar siguiente
Track omlaag	Traccia giù	Pista anterior
Track omhoog	Traccia su	Pista siguiente
RSS	RSS	RSS
weer	Tempo	tiempo
Facebook	Facebook	Facebook
status	Stato	Estatus
Twitter	Twitter	Twitter
Tweet	Tweet	Tweet
E-mail	Mail	Correo
Ik ben hier	Ci sono	Estoy aquí
Ik luister	In ascolto	Escucho
Rooster	Programm	Programa
View Map	View Map	View Map

Displaying Voice Commands

The available voice commands depend on each screen and you can find them by pressing and holding the Push-To-Talk switch.

1 Press and hold the Push-To-Talk switch.



The list of operable voice commands appears. Pronounce a command.

Note

- About the voice command for navigation system, refer to the instruction manual of the navigation system.
- *1 DNN9250DAB only
- *2 DNN991HD only