

KENWOOD

KDC-361U
KDC-261UB
KDC-261UR
KDC-161UB

KDC-161UR
KDC-161UG
KDC-130Y
KDC-120RY

KDC-100Q
KDC-161URY

CD-RECEIVER

INSTRUCTION MANUAL

CD-RECEIVER

BEDIENUNGSANLEITUNG

CD-РЕСИВЕР

ИНСТРУКЦИЯ ПО ЭКСПЛУАТАЦИИ

CD-РЕСИВЕР

ІНСТРУКЦІЯ З ЕКСПЛУАТАЦІЇ

JVC KENWOOD Corporation



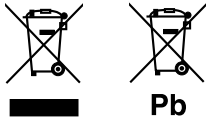

Pb

Information on Disposal of Old Electrical and Electronic Equipment and Batteries (applicable for EU countries that have adopted separate waste collection systems)
Products and batteries with the symbol (crossed-out wheeled bin) cannot be disposed as household waste.

Old electrical and electronic equipment and batteries should be recycled at a facility capable of handling these items and their waste byproducts.

Contact your local authority for details in locating a recycle facility nearest to you. Proper recycling and waste disposal will help conserve resources whilst preventing detrimental effects on our health and the environment.

Notice: The sign "Pb" below the symbol for batteries indicates that this battery contains lead.

Entsorgung von gebrauchten elektrischen und elektronischen Geräten und Batterien (anzuwenden in den Ländern der Europäischen Union und anderen europäischen Ländern mit einem separaten Sammelsystem für solche Geräte)

Das Symbol (durchgestrichene Mülltonne) auf dem Produkt oder seiner Verpackung weist darauf hin, dass dieses Produkt nicht als normaler Haushaltsabfall behandelt werden darf, sondern an einer Annahmestelle für das Recycling von elektrischen und elektronischen Geräten und Batterien abgegeben werden muss.

Durch Ihren Beitrag zur korrekten Entsorgung dieses Produktes schützen Sie die Umwelt und die Gesundheit Ihrer Mitmenschen.

Unschädlige oder falsche Entsorgung gefährden Umwelt und Gesundheit. Weitere Informationen über das Recycling dieses Produktes erhalten Sie von Ihrer Gemeinde oder den kommunalen Entsorgungsbetrieben.

Achtung: Das Zeichen „Pb“ unter dem Symbol für Batterien zeigt an, dass diese Batterie Blei enthält.

For Israel

מידע בדבר השלכה לאשפה של ציוד חשמלי ואלקטרוני ישן וסוללות (רלוונטי למדינת שמשותפת במערכת איסוף אשפה מופרדת).

לא ניתן להשליך מוצרים וסוללות עם הימון (פח אשפה עם X עליו) כאשפה ביתית גיולה. יש למחור ציוד חשמלי ואלקטרוני ישן וכן סוללות במתקן המסוגל לטפל בפריטים כאלה ובתוצרי הלואי שלהם. צרו קשר עם הרשות המקומית לקבלת פרטים אודות מתקן המיחזור הקרוב אליכם. מיחזור והשלכה לאשפה נאותים יעזרו לשמר משאבים ולמנוע השפעות שליליות על בריאותנו ועל הסביבה. שימו לב: הימון Pb שמתחת לימון עובר סוללות מצוין שהסוללה מכילה עופרת.



Declaration of Conformity with regard to the EMC Directive 2004/108/EC
Declaration of Conformity with regard to the RoHS Directive 2011/65/EU

Manufacturer:

JVC KENWOOD Corporation

3-12, Moriya-cho, Kanagawa-ku, Yokohama-shi, Kanagawa, 221-0022, Japan

EU Representative:

JVCKENWOOD NEDERLAND B.V.

Amsterdamseweg 37, 1422 AC UITHOORN, The Netherlands

Konformitätserklärung in Bezug auf die EMC-Vorschrift 2004/108/EC

Konformitätserklärung in Bezug auf die RoHS-Vorschrift 2011/65/EU

Hersteller:

JVC KENWOOD Corporation

3-12, Moriya-cho, Kanagawa-ku, Yokohama-shi, Kanagawa, 221-0022, Japan

EU-Vertreter:

JVCKENWOOD NEDERLAND B.V.

Amsterdamseweg 37, 1422 AC UITHOORN, Niederlande

For Turkey

Bu ürün 28300 sayılı Resmî Gazete'de yayımlanan Atık Elektrikli ve Elektronik Eşyaların Kontrolü Yönetmeliğe uygun olarak üretilmiştir.

Eski Elektrik ve Elektronik Ekipmanların İmha Edilmesi Hakkında Bilgi (ayrı atık toplama sistemlerini kullanan ülkeleri için uygulanabilir)



Sembollü (üzerinde çarpı işareti olan çöp kutusu) ürünler ev atıkları olarak atılamaz.

Eski elektrik ve elektronik ekipmanlar, bu ürünleri ve ürün atıklarını geri dönüştürebilecek bir tesiste değerlendirilmelidir. Yaşadığımız bölgeye en yakın geri dönüşüm tesisinin yerini öğrenmek için yerel makamlara müracaat edin. Uygun geri dönüşüm ve atık imha yöntemi sağlığımız ve çevremiz üzerindeki zararlı etkileri önlerken kaynakların korunmasına da yardımcı olacaktır.



The marking of products using lasers

The label is attached to the chassis/case and says that the component uses laser beams that have been classified as Class 1. It means that the unit is utilizing laser beams that are of a weaker class. There is no danger of hazardous radiation outside the unit.

Kennzeichnung von Geräten mit Laser-Abtastern

Das Etikett ist am Chassis/Gehäuse angebracht und besagt, dass sich die Komponente Laserstrahlen bedient, die als Laserstrahlen der Klasse 1 klassifiziert wurden. Dies weist darauf hin, dass sich das Gerät Laserstrahlen bedient, die einer schwächeren Klasse angehören. Das bedeutet, dass durch den sehr schwachen Laserstrahl keine Gefahr durch gefährliche Strahlungen außerhalb des Geräts besteht.

Маркировка изделий, использующих лазеры

К корпусу устройства прикреплена табличка, указывающая, что устройство использует лазерные лучи класса 1. Это означает, что в устройстве используются лазерные лучи слабой интенсивности. Они не представляют опасности и не распространяют опасную радиацию вне устройства.

Маркування виробів, обладнаних лазером

На каркас/корпус поміщається наклейка, в якій зазначається, що даний виріб випромінює лазерні промені Класу 1. Це означає, що даний апарат використовує лазерні промені слабшого класу. За межами даного апарату не існує небезпеки лазерного випромінювання.



Дата изготовления (месяц/год) находится на этикетке устройства.

При Правильном соблюдении всех условий эксплуатации и технических требований, указанных в данной инструкции, срок службы купленного Вами изделия составляет 7 лет. Гарантийный срок эксплуатации изделия соответствует сроку, указанному в гарантийном талоне. В период срока службы эксплуатация и хранение изделия не может представлять опасность для Вашей жизни, здоровья, причинять вред Вашему имуществу или окружающей среде.

Декларація про Відповідність Вимогам Технічного Регламенту Обмеження Використання деяких Небезпечних Речовин в електричному та електронному обладнанні (затвердженого Постановою №1057 Кабінету Міністрів України)

Виріб відповідає вимогам Технічного Регламенту Обмеження Використання деяких Небезпечних Речовин в електричному та електронному обладнанні (ТР ОБНР).

Вміст небезпечних речовин у випадках, не обумовлених в Додатку №2 ТР ОБНР:

1. свинець (Pb) – не перевищує 0.1 % ваги речовини або в концентрації до 1000 частин на мільйон;
2. кадмій (Cd) – не перевищує 0.01 % ваги речовини або в концентрації до 100 частин на мільйон;
3. ртуть (Hg) – не перевищує 0.1 % ваги речовини або в концентрації до 1000 частин на мільйон;
4. шестивалентний хром (Cr 6+) – не перевищує 0.1 % ваги речовини або в концентрації до 1000 частин на мільйон;
5. полібромбіфеноли (PBV) – не перевищує 0.1% ваги речовини або в концентрації до 1000 частин на мільйон;
6. полібромдефенілові ефіри (PBDE) – не перевищує 0.1 % ваги речовини або в концентрації до 1000 частин на мільйон.

CONTENTS

BEFORE USE	2
BASICS	3
GETTING STARTED	4
RADIO	5
CD / USB / iPod	6
AUX	8
AUDIO SETTINGS	9
DISPLAY SETTINGS	10
MORE INFORMATION	10
TROUBLESHOOTING	11
INSTALLATION / CONNECTION	12
SPECIFICATIONS	15

How to read this manual

- Operations are explained mainly using buttons on the faceplate.
- [XX] indicates the selected items.
- (➔ XX) indicates references are available on the stated page.

BEFORE USE

▲ Warning

Do not operate any function that takes your attention away from safe driving.

▲ Caution

Volume setting:

- Adjust the volume so that you can hear sounds outside the car to prevent accidents.
- Lower the volume before playing digital sources to avoid damaging the speakers by the sudden increase of the output level.

General:

- Avoid using the USB device or iPod/iPhone if it might hinder safe driving.
- Make sure all important data has been backed up. We shall bear no responsibility for any loss of recorded data.
- Never put or leave any metallic objects (such as coins or metal tools) inside the unit, to prevent a short circuit.
- If a disc error occurs due to condensation on the laser lens, eject the disc and wait for the moisture to evaporate.

Remote control (RC-406):

- Do not leave the remote control in hot places such as on the dashboard.
- The Lithium battery is in danger of explosion if replaced incorrectly. Replace it only with the same or equivalent type.
- The battery pack or batteries shall not be exposed to excessive heat such as sunshine, fire or the like.
- Keep the battery out of reach of children and in its original packaging when not in used. Dispose of used batteries promptly. If swallowed, contact a physician immediately.

Maintenance

Cleaning the unit: Wipe off dirt on the faceplate with a dry silicone or soft cloth.

Cleaning the connector: Detach the faceplate and clean the connector gently with a cotton swab, being careful not to damage the connector.

Handling discs:

- Do not touch the recording surface of the disc.
- Do not stick tape etc. on the disc, or use a disc with tape stuck on it.
- Do not use any accessories for the disc.
- Clean from the center of the disc and move outward.
- Clean the disc with a dry silicone or soft cloth. Do not use any solvents.
- When removing discs from this unit, pull them out horizontally.
- Remove burrs from the center hole and disc edge before inserting a disc.

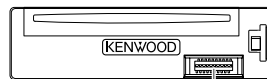

Connector (on the reverse side of the faceplate)

BASICS

Faceplate

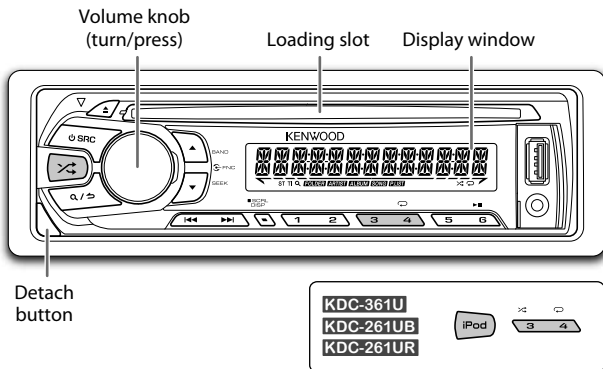

Attach

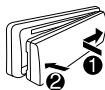

Detach

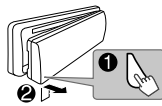

How to reset

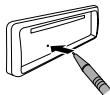

Your preset adjustments will also be erased.

Remote control (RC-406) (supplied for **KDC-130Y**)

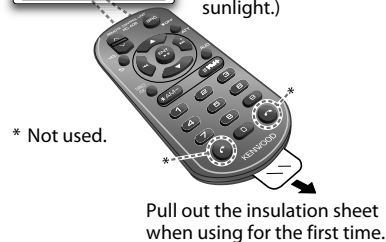

How to replace the battery

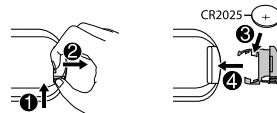

To	Do this (on the faceplate)	Do this (on the remote control)
Turn on the power	Press SRC . • Press and hold to turn off the power.	Press and hold SRC to turn off the power. (Pressing SRC does not turn on the power.)
Adjust the volume	Turn the volume knob.	Press VOL \wedge or VOL \vee . Press ATT during playback to attenuate the sound. • Press again to cancel.
Select a source	Press SRC repeatedly.	Press SRC repeatedly.
Change the display information	Press DISP SCRL repeatedly. • Press and hold to scroll the current display information.	(not available)

GETTING STARTED

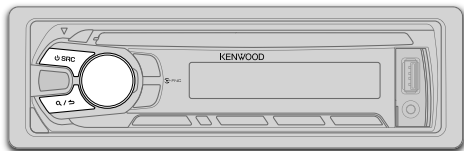

1 Select the display language and cancel the demonstration

When you turn on the power (or after you reset the unit), the display shows: "SEL LANGUAGE" → "PRESS" → "VOLUME KNOB"

- 1 Turn the volume knob to select [ENG] (English) or [RUS] (Russian), then press the knob.
[ENG] is selected for the initial setup.

Then, the display shows: "CANCEL DEMO" → "PRESS" → "VOLUME KNOB"

- 2 Press the volume knob.
[YES] is selected for the initial setup.
- 3 Press the volume knob again.
"DEMO OFF" appears.

2 Set the clock

- 1 Press the volume knob to enter [FUNCTION].
- 2 Turn the volume knob to select [CLOCK], then press the knob.
- 3 Turn the volume knob to select [CLOCK ADJUST], then press the knob.
- 4 Turn the volume knob to make the settings, then press the knob.
Day → Hour → Minute
- 5 Turn the volume knob to select [CLOCK FORMAT], then press the knob.

- 6 Turn the volume knob to select [12H] or [24H], then press the knob.
- 7 Press and hold Q/↵ to exit.

(or)

- 1 Press and hold **DISP SCRL** to enter clock adjustment mode directly while in clock display screen.
- 2 Turn the volume knob to make the settings, then press the knob.
Day → Hour → Minute

To return to the previous setting item or hierarchy, press Q/↵.

3 Set the initial settings

- 1 Press **SRC** to enter **STANDBY**.
- 2 Press the volume knob to enter [FUNCTION].
- 3 Turn the volume knob to make a selection (see the following table), then press the knob.
- 4 Press and hold Q/↵ to exit.

To return to the previous setting item or hierarchy, press Q/↵.

Default: **XX**

AUDIO CONTROL

SWITCH PREOUT (Except for **KDC-100Q**)
REAR/ SUB-W: Selects whether rear speakers or a subwoofer are connected to the line out terminals on the rear (through an external amplifier).

SP SELECT **OFF/ 5/4/ 6 × 9/6/ OEM**: Selects according to the speaker size (5 inches or 4 inches, 6×9 inches or 6 inches) or OEM speakers for optimum performance.

DISPLAY

EASY MENU (For **KDC-361U/ KDC-130Y**)
ON: Both display and button illumination change to white color when entering [FUNCTION]. ; **OFF**: Both display and button illumination remain as [COLOR SELECT] color. (→ 10)

TUNER SETTING

PRESET TYPE **NORMAL**: Memorizes one station for each preset button in each band (FM1/ FM2/ FM3/ MW/ LW). ; **MIX**: Memorizes one station for each preset button, regardless of the selected band.

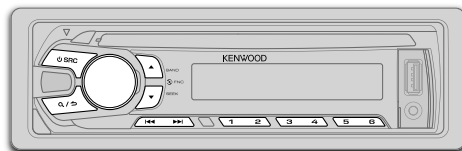

SYSTEM	
KEY BEEP	ON: Activates the keypress tone. ; OFF: Deactivates.
SOURCE SELECT	
BUILT-IN AUX	ON: Enables AUX in source selection. ; OFF: Disables. (→ 8)
RUSSIAN SET	Selects the display language for [FUNCTION] menu and Tag information (folder name, file name, song title, artist name, album name) if applicable. RUSSIAN OFF: Display language is English. ; РУССКИЙ ВКЛ: Display language is Russian.
P-OFF WAIT	Applicable only when the demonstration mode is turned off. Sets the duration when the unit will automatically turn off (while in standby mode) to save the battery. 20M: 20 minutes ; 40M: 40 minutes ; 60M: 60 minutes ; OFF ---: Cancels
CD READ	1: Automatically distinguishes between audio file disc and music CD. ; 2: Forces to play as an music CD. No sound can be heard if an audio file disc is played.
F/W UPDATE	
UPDATE SYSTEM	
F/W UP xx.xx	YES: Starts upgrading the firmware. ; NO: Cancels (upgrading is not activated). For details on how to update the firmware, see: www.kenwood.com/cs/ce/

Search for a station

- Press **SRC** to select TUNER.
- Press **▲ BAND** repeatedly (or press ***AM-** / **#FM+** on RC-406) to select FM1/ FM2/ FM3/ MW/ LW.
- Press **◀◀ / ▶▶** (or press **◀◀ / ▶▶ (+)** on RC-406) to search for a station.
 - To change the searching method for **◀◀ / ▶▶**: Press **▼ SEEK** repeatedly.
 - AUTO1:** Automatically search for a station.
 - AUTO2:** Automatically search for a preset station.
 - MANUAL:** Manually search for a station.
 - To store a station: Press and hold one of the number buttons (**1** to **6**).
 - To select a stored station: Press one of the number buttons (**1** to **6**) (or press one of the number buttons (**1** to **6**) on RC-406).

Direct Access Tuning (using RC-406) (for KDC-130Y)

- Press **DIRECT** to enter Direct Access Tuning.
“- - - -” (for FM) or “- - - -” (for MW/ LW) appears on the display.
- Press the number buttons to enter a frequency.
- Press **ENT ▶▶** to search for a station.
 - To cancel, press **↵** or **DIRECT**.
 - If no operation is done for 10 seconds after step 2, Direct Access Tuning is automatically canceled.

Other settings

- Press the volume knob to enter [FUNCTION].
- Turn the volume knob to make a selection (see the following table), then press the knob.
- Press and hold **Q / ↵** to exit.

To return to the previous setting item or hierarchy, press **Q / ↵**.

Default: **XX**

TUNER SETTING

LOCAL SEEK	ON: Searches only FM stations with good reception. ; OFF: Cancels.
AUTO MEMORY	YES: Automatically starts memorizing 6 stations with good reception. ; NO: Cancels. (Selectable only if [NORMAL] is selected for [PRESET TYPE].) (↔ 4)
MONO SET	ON: Improves the FM reception, but the stereo effect may be lost. ; OFF: Cancels.
NEWS SET	ON: The unit will temporarily switch to News Programme if available. ; OFF: Cancels.
REGIONAL	ON: Switches to another station only in the specific region using the "AF" control. ; OFF: Cancels.
AF SET	ON: Automatically searches for another station broadcasting the same program in the same Radio Data System network with better reception when the current reception is poor. ; OFF: Cancels.
TI	ON: Allows the unit to temporarily switch to Traffic Information. ; OFF: Cancels.
PTY SEARCH	Press the volume knob to enter PTY language selection. Turn the volume knob to select the PTY language (ENGLISH/ FRENCH/ GERMAN), then press the knob. Selects the available Program Type (see the following), then, press ◀◀ / ▶▶ to start.

CLOCK

TIME SYNC	ON: Synchronizes the unit's time to the Radio Data System station time. ; OFF: Cancels.
------------------	---

- Except for **[KDC-100Q]**: **[LOCAL SEEK]/ [MONO SET]/ [NEWS SET]/ [REGIONAL]/ [AF SET]/ [TI]/ [PTY SEARCH]** is selectable only when the band is FM1/ FM2/ FM3.
 - For **[KDC-100Q]**: **[LOCAL SEEK]/ [MONO SET]/ [NEWS SET]/ [REGIONAL]/ [AF SET]/ [TI]/ [PTY SEARCH]** is selectable only when the band is FM1/ FM2. When the band is FM3, **[LOCAL SEEK]** can only be selected.
 - Available Program Type:
 - SPEECH:** NEWS, AFFAIRS, INFO (information), SPORT, EDUCATE, DRAMA, CULTURE, SCIENCE, VARIOUS, WEATHER, FINANCE, CHILDREN, SOCIAL, RELIGION, PHONE IN, TRAVEL, LEISURE, DOCUMENT
 - MUSIC:** POP M (music), ROCK M (music), EASY M (music), LIGHT M (music), CLASSICS, OTHER M (music), JAZZ, COUNTRY, NATION M (music), OLDIES, FOLK M (music)
- The unit will search for the Program Type categorized under **[SPEECH]** or **[MUSIC]** if selected.
- If the volume is adjusted during reception of traffic information, alarm or news bulletin, the adjusted volume is memorized automatically. It will be applied the next time traffic information, alarm or news bulletin function is turned on.

Start playback

The source changes automatically and playback starts.

CD

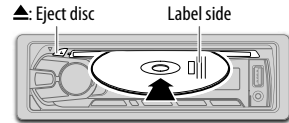

USB

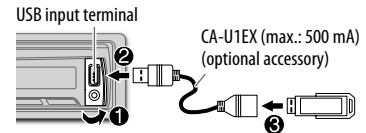

iPod/iPhone (for [KDC-361U]/ [KDC-261UB]/ [KDC-261UR])

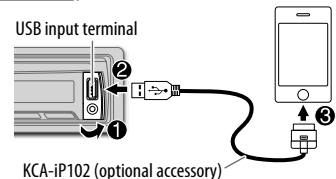

Press and hold iPod to select the control mode while in iPod source.
MODE ON: From the iPod. (↔ 7, *1)
MODE OFF: From the unit.

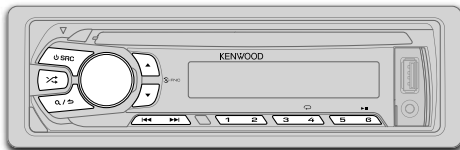
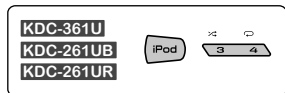

To	Do this
Pause or resume playback	Press 6 (or press ENT on RC-406).
Select a track/file	Press (or press (+) on RC-406).
Select a folder *2	Press / (or press *AM- / #FM+ on RC-406).
Reverse/ Fast-forward	Press and hold (or press and hold (+) on RC-406).
Repeat play *3	Press 4 repeatedly. <ul style="list-style-type: none"> • Audio CD: TRACK REPEAT, REPEAT OFF • MP3/WMA/WAV file or iPod: FILE REPEAT, FOLDER REPEAT, REPEAT OFF • KENWOOD Music Editor Light (KME Light)/ KENWOOD Music Control (KMC) file (10): FILE REPEAT, REPEAT OFF
Random play *3	Press 3 or repeatedly. <ul style="list-style-type: none"> • Audio CD: DISC RANDOM, RANDOM OFF • MP3/WMA/WAV file or iPod or KME Light/ KMC file: FOLDER RANDOM, RANDOM OFF <p>Press and hold 3 or to select "ALL RANDOM". *4</p>

*1 You can still play/pause, file search, fast-forward or reverse files from the unit.

*2 Only for MP3/WMA/WAV files. This does not work for iPod.

*3 For iPod: Applicable only when [MODE OFF] is selected.

*4 For CD: Only for MP3/WMA files.

If you connect the iPod/iPhone to the USB input terminal of the unit (while listening to Tuneln, Tuneln Radio Pro or Aupeo), the unit will output the sound from these apps.

Select a track/file from a list

For iPod: Applicable only when [MODE OFF] is selected. (**6**)

- 1 Press .
- 2 Turn the volume knob to make a selection, then press the knob.

- MP3/WMA/WAV file: Select the desired folder, then a file.
- iPod or KME Light/ KMC file: Select the desired file from the list (PLAYLISTS, ARTISTS, ALBUMS, SONGS, PODCASTS*, GENRES, COMPOSERS*).

* Only for iPod.

- To return to the root folder (or first file), press number button **5**.
- To return to the previous setting item or hierarchy, press .
- To cancel, press and hold .

If you have many files...

You can search through them quickly (on step **2** above) at a preset skip search ratio by pressing .

- See also "Set the skip search ratio." (**8**)
- Pressing and holding skip songs at the maximum ratio (10%) regardless of the setting made.
- For USB: Only for files registered in the database created with KME Light/ KMC.
- Not applicable for audio CD.

Direct Music Search (using RC-406) (for KDC-130Y)

- 1 Press **DIRECT**.
- 2 Press the number buttons to enter a track/file number.
- 3 Press **ENT ▶ ||** to search for music.
 - To cancel, press **↵**.
 - Not available if Random Play is selected.
 - Not applicable for iPod, KME Light/ KMC file.

Select a song by name

While listening to iPod...

- 1 Press **Q / ↵**.
- 2 Turn the volume knob to select a category, then press the knob.
- 3 Turn the volume knob quickly to enter character search.
- 4 Turn the volume knob to select the character to be searched for.
- 5 Press **◀ / ▶** to move to the entry position.
You can enter up to 3 characters.
- 6 Press the volume knob to start searching.
- 7 Turn the volume knob to make a selection, then press the knob.
Repeat step 7 until the desired item is selected.
 - To search for a character other than A to Z and 0 to 9, enter only "*/".
 - To return to the previous hierarchy, press **Q / ↵**.
 - To return to the top menu, press number button **5**.
 - To cancel, press and hold **Q / ↵**.

Set the skip search ratio

While listening to iPod or KME Light/ KMC file...

- 1 Press the volume knob to enter [FUNCTION].
- 2 Turn the volume knob to select [USB], then press the knob.
- 3 Turn the volume knob to select [SKIP SEARCH], then press the knob.
- 4 Turn the volume knob to make a selection, then press the knob.
0.5% (default)/ 1%/ 5%/ 10%: Skip search ratio over the total files.
- 5 Press and hold **Q / ↵** to exit.

Change the USB drive

When a smartphone (Mass Storage Class) is connected to the USB input terminal, you can select its internal memory or external memory (such as an SD card) to playback the stored songs. You can also select the desired drive to playback when a multiple drives device is connected.

Press number button **5** repeatedly to select the desired drive.

(or)

- 1 Press the volume knob to enter [FUNCTION].
- 2 Turn the volume knob to select [USB], then press the knob.
- 3 Turn the volume knob to select [MUSIC DRIVE], then press the knob.
- 4 Press the volume knob to select [DRIVE CHANGE].

The next drive is selected automatically.

Repeat steps **1** to **4** to select the following drives.

Selectable items: [DRIVE 1] to [DRIVE 5]

Preparation:

Select [ON] for [BUILT-IN AUX]. (→ 5)

Start listening

- 1 Connect a portable audio player (commercially available).

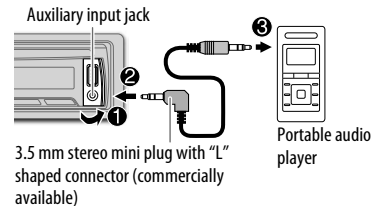

- 2 Press **⏻ SRC** to select AUX.
- 3 Turn on the portable audio player and start playback.

Set the AUX name

While listening to a portable audio player connected to the unit...

- 1 Press the volume knob to enter [FUNCTION].
- 2 Turn the volume knob to select [SYSTEM], then press the knob.
- 3 Turn the volume knob to select [AUX NAME SET], then press the knob.
- 4 Turn the volume knob to make a selection, then press the knob.
AUX (default)/ DVD/ PORTABLE/ GAME/ VIDEO/ TV
- 5 Press and hold **Q / ↵** to exit.

AUDIO SETTINGS

While listening to any source...

- 1 Press the volume knob to enter [FUNCTION].
- 2 Turn the volume knob to select [AUDIO CONTROL], then press the knob.
- 3 Turn the volume knob to make a selection (see the following table), then press the knob.
Repeat step 3 until the desired item is selected or activated.
- 4 Press and hold **Q**/**↵** to exit.

(or using RC-406)

- 1 Press **AUD** to enter [AUDIO CONTROL].
- 2 Press **▲**/**▼** to make a selection, then press **ENT ▶** **||**.

To return to the previous setting item or hierarchy, press **Q**/**↵**.

Default: **XX**

SUB-W LEVEL*	-15 to +15 (0):	Adjusts the subwoofer output level.
BASS LEVEL	-8 to +8 (+6):	
MID LEVEL	-8 to +8 (+5):	Adjusts the level to memorize for each source. (Before making an adjustment, select the source you want to adjust.)
TRE LEVEL	-8 to +8 (0):	
EQ PRO		
BASS ADJUST	BASS CTR FRQ	60/ 80/ 100/ 200: Selects the center frequency.
	BASS LEVEL	-8 to +8 (+6): Adjusts the level.
	BASS Q FACTOR	1.00/ 1.25/ 1.50/ 2.00: Adjusts the quality factor.
	BASS EXTEND	ON: Turns on the extended bass. ; OFF: Cancels.
MID ADJUST	MID CTR FRQ	0.5/ 1.0/ 1.5/ 2.5K: Selects the center frequency.
	MID LEVEL	-8 to +8 (+5): Adjusts the level.
	MID Q FACTOR	0.75/ 1.00/ 1.25: Adjusts the quality factor.
TRE ADJUST	TRE CTR FRQ	10.0/ 12.5/ 15.0/ 17.5K: Selects the center frequency.
	TRE LEVEL	-8 to +8 (0): Adjusts the level.

PRESET EQ	DRIVE EQ/ TOP40/ POWERFUL/ ROCK/ POPS/ EASY/ JAZZ/ NATURAL/ USER: Selects a preset equalizer suitable to the music genre. (Select [USER] to use the customized bass, middle, and treble settings.) [DRIVE EQ] is a preset equalizer that reduces noise from the road.
BASS BOOST	LV1/ LV2/ LV3: Selects your preferred bass boost level. ; OFF: Cancels.
LOUDNESS	LV1/ LV2: Selects your preferred low and high frequencies boost to produce a well-balanced sound at a low volume level. ; OFF: Cancels.
SUBWOOFER SET*	ON: Turns on the subwoofer output. ; OFF: Cancels.
LPF SUBWOOFER*	THROUGH: All signals are sent to the subwoofer. ; 85HZ/ 120HZ/ 160HZ: Audio signals with frequencies lower than 85 Hz/ 120 Hz/ 160 Hz are sent to the subwoofer.
SUB-W PHASE*	REVERSE (180°)/ NORMAL (0°): Selects the phase of the subwoofer output to be in line with the speaker output for optimum performance. (Selectable only if a setting other than [THROUGH] is selected for [LPF SUBWOOFER].)
FADER	R15 to F15 (0): Adjusts the rear and front speaker output balance.
BALANCE	L15 to R15 (0): Adjusts the left and right speaker output balance.
VOLUME OFFSET (Default: 0)	-8 to +8 (for AUX) ; -8 to 0 (for other sources): Presets the volume adjustment level of each source. (Before adjustment, select the source you want to adjust.)
SOUND RECNRSTR (Sound reconstruction)	ON: Creates realistic sound by compensating the high-frequency components and restoring the rise-time of the waveform that are lost in audio data compression. ; OFF: Cancels.

- [SUB-W LEVEL]/ [SUBWOOFER SET]/ [LPF SUBWOOFER]/ [SUB-W PHASE] is selectable only if [SWITCH PREOUT] is set to [SUB-W]. (→ 4)
- [SUB-W LEVEL]/ [LPF SUBWOOFER]/ [SUB-W PHASE] is selectable only if [SUBWOOFER SET] is set to [ON].

* Except for **[KDC-100Q]**.

DISPLAY SETTINGS

- 1 Press the volume knob to enter [FUNCTION].
- 2 Turn the volume knob to select [DISPLAY], then press the knob.
- 3 Turn the volume knob to make a selection (see the following table), then press the knob. Repeat step 3 until the desired item is selected or activated.
- 4 Press and hold **Q** / **S** to exit.

To return to the previous setting item or hierarchy, press **Q** / **S**.

Default: **XX**

COLOR SELECT*	VARIABLE SCAN/ COLOR 01 — COLOR 24/ USER: Selects your preferred button illumination color. You can create your own color (when [COLOR 01] — [COLOR 24] or [USER] is selected). The color you have created can be selected when you select [USER]. <ol style="list-style-type: none">1 Press and hold the volume knob to enter the detailed color adjustment.2 Press ◀◀ / ▶▶ to select the color (R/ G/ B) to adjust.3 Turn the volume knob to adjust the level (0 — 9), then press the knob.
DIMMER	ON: Dims the display illumination (and button illumination*). ; OFF: Illuminates according to the [BRIGHTNESS] settings.
BRIGHTNESS	LVL 0 — LVL 31: Selects your preferred brightness level for display illumination (and button illumination*).
TEXT SCROLL	AUTO/ ONCE: Selects whether to scroll the display information automatically, or scroll only once. ; OFF: Cancels.

* For **KDC-361U** / **KDC-130Y**.

MORE INFORMATION

General

• This unit can only play the following CDs:



- Detailed information and notes about the playable audio files are stated in an online manual on the following web site: www.kenwood.com/cs/ce/audiofile/

Playable files

- Playable audio file: MP3 (.mp3), WMA (.wma)
 - Playable disc media: CD-R/CD-RW/CD-ROM
 - Playable disc file format: ISO 9660 Level 1/2, Joliet, Long file name.
 - Playable USB device file system: FAT12, FAT16, FAT32
- Even when audio files comply with the standards listed above, playback may be impossible depending on the types or conditions of media or device.

Unplayable discs

- Discs that are not round.
- Discs with coloring on the recording surface or discs that are dirty.
- Recordable/ReWritable discs that have not been finalized.
- 8 cm CD. Attempting to insert using an adapter may cause malfunction.

About USB devices

- This unit can play MP3/WMA/WAV files stored on a USB mass storage class device.
- You cannot connect a USB device via a USB hub.
- Connecting a cable whose total length is longer than 5 m may result in abnormal playback.
- This unit cannot recognize a USB device whose rating is other than 5 V and exceeds 1 A.

About KENWOOD Music Editor Light and KENWOOD Music Control

- This unit supports the PC application KENWOOD Music Editor Light and Android™ application KENWOOD Music Control.
- When you play audio files with song data added using the KENWOOD Music Editor Light or KENWOOD Music Control, you can search for audio files by Genres, Artists, Albums, Playlists, and Songs.
- KENWOOD Music Editor Light and KENWOOD Music Control are available on the following web site: www.kenwood.com/cs/ce/

About iPod/iPhone

Made for

- iPod touch (1st, 2nd, 3rd, 4th, and 5th generation)
- iPod classic
- iPod nano (3rd, 4th, 5th, 6th, and 7th generation)
- iPhone, iPhone 3G, 3GS, 4, 4S, 5
- For the latest compatible list and software versions of iPhone/iPod, see: www.kenwood.com/cs/ce/ipod
- To connect devices featuring Lightning connector, both KCA-iP102 (optional accessory) and Apple Lightning to 30-pin Adapter (accessory of the iPod/iPhone) are required.
Do not leave the Apple Lightning to 30-pin Adapter inside the car to prevent damages caused by the hot temperature.
- You cannot operate iPod if “KENWOOD” or “✓” is displayed on iPod.

TROUBLESHOOTING

Symptom	Remedy
Sound cannot be heard.	<ul style="list-style-type: none">Adjust the volume to the optimum level.Check the cords and connections.
"PROTECT" appears and no operations can be done.	Check to be sure the terminals of the speaker wires are insulated properly, then reset the unit. If this does not solve the problem, consult your nearest service center.
<ul style="list-style-type: none">Sound cannot be heard.The unit does not turn on.Information shown on the display is incorrect.	Clean the connectors. (→ 2)
The unit does not work at all.	Reset the unit. (→ 3)
<ul style="list-style-type: none">Radio reception is poor.Static noise while listening to the radio.	<ul style="list-style-type: none">Connect the antenna firmly.Pull the antenna out all the way.
"NA FILE" appears.	Make sure the disc contains supported audio files. (→ 10)
"NO DISC" appears.	Insert a playable disc into the loading slot.
"TOC ERROR" appears.	Make sure the disc is clean and inserted properly.
"PLEASE EJECT" appears.	Reset the unit. If this does not solve the problem, consult your nearest service center.
Disc cannot be ejected.	Press and hold  to forcibly eject the disc. Be careful not to drop the disc when it is ejected. If this does not solve the problem, reset the unit. (→ 3)
"READ ERROR" appears.	Copy the files and folders onto the USB device again. If this does not solve the problem, reset the USB device or use another USB device.
"NO DEVICE" appears.	Connect a USB device, and change the source to USB again.
"COPY PRO" appears.	A copy-protected file is played.

Symptom	Remedy
"NA DEVICE" appears.	Connect a supported USB device, and check the connections.
"NO MUSIC" appears.	Connect a USB device that contains playable audio files.
"iPod ERROR" appears.	<ul style="list-style-type: none">Reconnect the iPod.Reset the iPod.
Noise is generated.	Skip to another track or change the disc.
Tracks do not play back as you intended them to play.	Playback order is determined when files are recorded.
"READING" keeps flashing.	Do not use too many hierarchical levels or folders.
Elapsed playing time is not correct.	This is caused by how the tracks are recorded.
Correct characters are not displayed (e.g. album name).	This unit can only display uppercase letters, numbers, and a limited number of symbols. Uppercase Cyrillic letters can also be displayed if [RUSSIAN SET] is set to [РУССКИЙ ВКЛ]. (→ 5)

Muting upon the reception of a phone call

Connect the MUTE wire to your telephone using a commercial telephone accessory. (→ 13, 14)

When a call comes in, "CALL" appears. (The audio system pauses.)

- To continue listening to the audio system during a call, press  **SRC**. "CALL" disappears and the audio system resumes.

When the call ends, "CALL" disappears. (The audio system resumes.)

▲ Warning

- The unit can only be used with a 12 V DC power supply, negative ground.
- Disconnect the battery's negative terminal before wiring and mounting.
- Do not connect Battery wire (yellow) and Ignition wire (red) to the car chassis or Ground wire (black) to prevent a short circuit.
- Insulate unconnected wires with vinyl tape to prevent a short circuit.
- Be sure to ground this unit to the car's chassis again after installation.

▲ Caution

- For safety's sake, leave wiring and mounting to professionals. Consult the car audio dealer.
- Install this unit in the console of your vehicle. Do not touch the metal parts of this unit during and shortly after use of the unit. Metal parts such as the heat sink and enclosure become hot.
- Do not connect the \ominus wires of speakers to the car chassis or Ground wire (black), or connect them in parallel.
- Mount the unit at an angle of less than 30°.
- If your vehicle wiring harness does not have the ignition terminal, connect Ignition wire (red) to the terminal on the vehicle's fuse box which provides 12 V DC power supply and is turned on and off by the ignition key.
- After the unit is installed, check whether the brake lamps, blinkers, wipers, etc. on the car are working properly.
- If the fuse blows, first make sure the wires are not touching car's chassis, then replace the old fuse with one that has the same rating.

Basic procedure

- 1 Remove the key from the ignition switch, then disconnect the \ominus terminal of the car battery.
- 2 Connect the wires properly.
See Wiring connection. (➔ 13, 14)
- 3 Install the unit to your car.
See Installing the unit (in-dash mounting).
- 4 Connect the \ominus terminal of the car battery.
- 5 Reset the unit. (➔ 3)

Installing the unit (in-dash mounting)

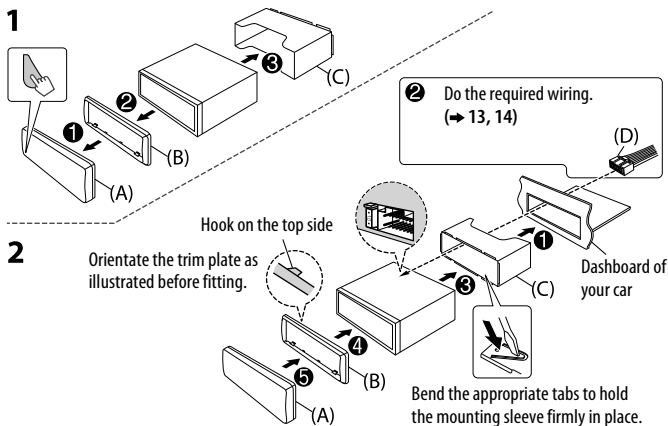

How to remove the unit

- 1 Detach the faceplate.
- 2 Fit the catch pin on the extraction keys into the holes on both sides of the trim plate, then pull it out.
- 3 Insert the extraction keys deeply into the slots on each side, then follow the arrows as shown on the right.

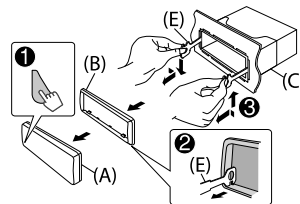

Wiring connection (except for [KDC-100Q])

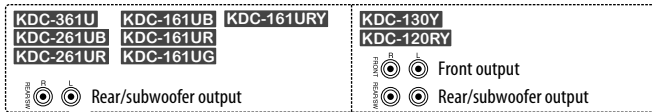

Connecting the ISO connectors on some VW/Audi or Opel (Vauxhall) automobiles

You may need to modify the wiring of the supplied wiring harness as illustrated below.

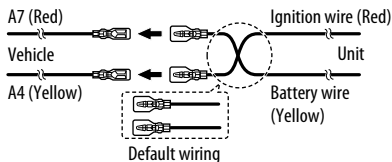

Pin	Color and function
A4	Yellow : Battery
A5	Blue/White : Power control
A7	Red : Ignition (ACC)
A8	Black : Earth (ground) connection
B1	Purple ⊕
B2	Purple/black ⊖ : Rear speaker (right)
B3	Gray ⊕
B4	Gray/black ⊖ : Front speaker (right)
B5	White ⊕
B6	White/black ⊖ : Front speaker (left)
B7	Green ⊕
B8	Green/black ⊖ : Rear speaker (left)

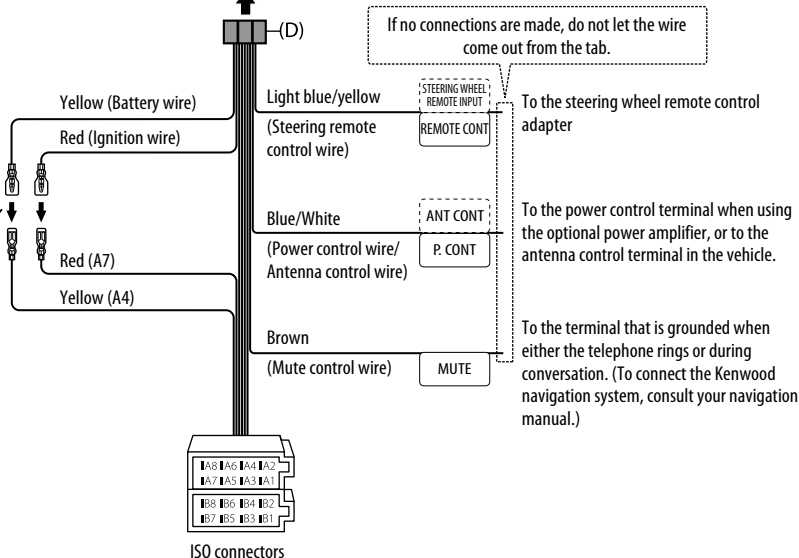

Wiring connection (for **KDC-100Q**)

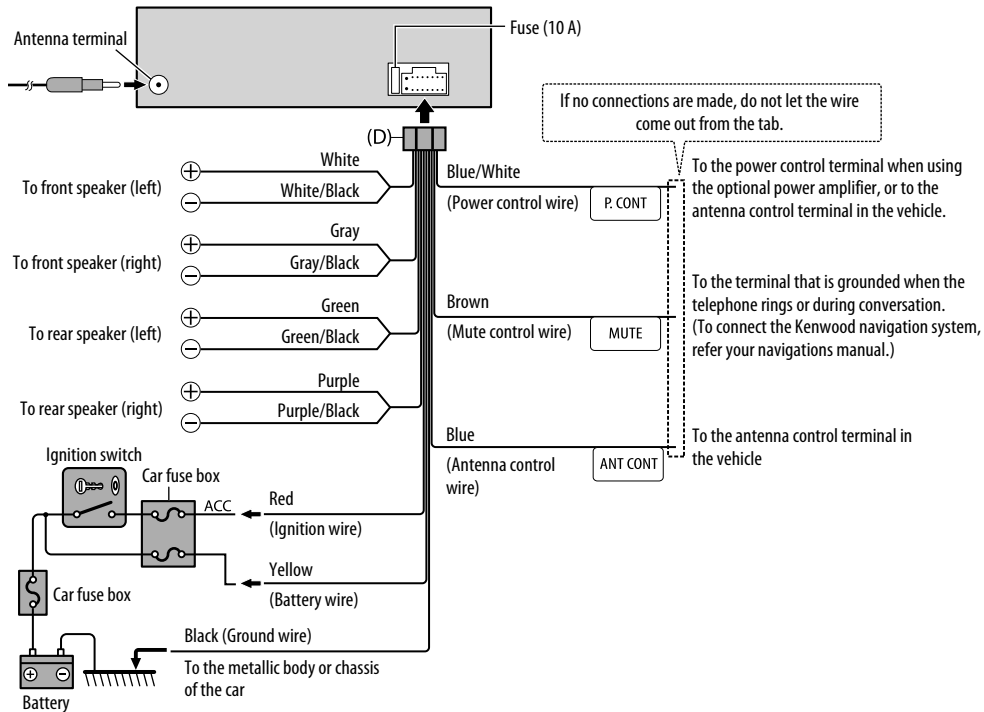

Part list for installation

(A) Faceplate

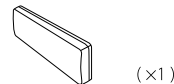

(B) Trim plate

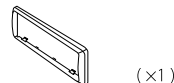

(C) Mounting sleeve

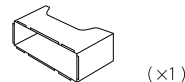

(D) Wiring harness (except for **KDC-100Q**)

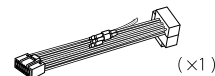

(for **KDC-100Q**)

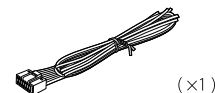

(E) Extraction key



SPECIFICATIONS

Tuner	FM Frequency Range	Except for KDC-100Q : FM1/ FM2/ FM3: 87.5 MHz — 108.0 MHz (50 kHz space) For KDC-100Q : FM1/ FM2: 87.5 MHz to 108.0 MHz (50 kHz space) FM3: 65.00 MHz to 74.00 MHz (30 kHz space)	
	Usable Sensitivity (S/N = 26 dB)	0.71 μ V/75 Ω	
	Quieting Sensitivity (DIN S/N = 46 dB)	2.0 μ V/75 Ω	
	Frequency Response (± 3 dB)	30 Hz — 15 kHz	
	Signal-to-Noise Ratio (MONO)	64 dB	
	Stereo Separation (1 kHz)	40 dB	
	MW Frequency Range	531 kHz — 1 611 kHz (9 kHz space)	
	Usable Sensitivity (S/N = 20 dB)	28.2 μ V	
LW Frequency Range	153 kHz — 279 kHz (9 kHz space)		
	Usable Sensitivity (S/N = 20 dB)	50 μ V	
CD player	Laser Diode	GaAlAs	
	Digital Filter (D/A)	8 times over sampling	
	Spindle Speed	500 rpm — 200 rpm (CLV)	
	Wow & Flutter	Below measurable limit	
	Frequency Response (± 1 dB)	20 Hz — 20 kHz	
	Total Harmonic Distortion (1 kHz)	0.01 %	
	Signal-to-Noise Ratio (1 kHz)	105 dB	
	Dynamic Range	90 dB	
	Channel Separation	85 dB	
	MP3 Decode	Compliant with MPEG-1/2 Audio Layer-3	
WMA Decode	Compliant with Windows Media Audio		
USB	USB Standard	USB 1.1, USB 2.0 (Full speed)	
	Maximum Supply Current	DC 5 V \equiv 1 A	
	File System	FAT12/16/ 32	
	MP3 Decode	Compliant with MPEG-1/2 Audio Layer-3	
	WMA Decode	Compliant with Windows Media Audio	
	WAV Decode	Linear-PCM	
Audio	Maximum Output Power	50 W \times 4	
	Output Power (DIN 45324, +B = 14.4 V)	30 W \times 4	
	Speaker Impedance	4 Ω — 8 Ω	
	Tone Action	Bass	200 Hz \pm 8 dB
		Middle	2.5 kHz \pm 8 dB
		Treble	12.5 kHz \pm 8 dB
Preout Level/Load (CD)	Except for KDC-100Q : 2 500 mV/10 k Ω		
Preout Impedance	\leq 600 Ω		
Auxiliary	Frequency Response (± 3 dB)	20 Hz — 20 kHz	
	Input Maximum Voltage	1 200 mV	
	Input Impedance	30 k Ω	
General	Operating Voltage	14.4 V (10.5 V — 16 V allowable)	
	Maximum Current Consumption	10 A	
	Operational Temperature Range	0°C — +40°C	
	Installation Size (W \times H \times D)	182 mm \times 53 mm \times 159 mm	
	Weight	1.2 kg	

Subject to change without notice.