

TH-D75A TH-D75E

USER MANUAL

This User Manual covers detailed operating instructions of the TH-D75A/E including basic operating instructions described in the User Guide comes with the product.

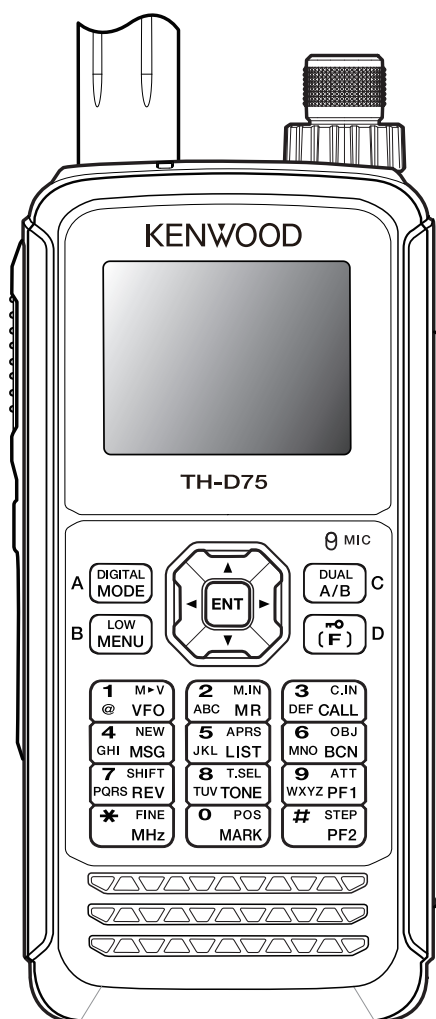

JVCKENWOOD Corporation

1 CONTENTS

1 CONTENTS	1	12 OTHER OPERATIONS	12-1
2 BEFORE STARTING	2-1	FREQUENCY STEP SIZE	12-1
3 PREPARATION	3-1	FINE TUNING	12-1
SUPPLIED ACCESSORIES	3-1	ATTENUATOR (ATT)	12-1
INSTALLING THE ANTENNA	3-1	PROGRAMMABLE VFO	12-2
INSTALLING THE BATTERY PACK	3-1	BEAT SHIFT	12-2
INSTALLING ALKALINE BATTERIES	3-1	AF/ IF/ DETECT OUTPUT MODE	12-2
INSTALLING THE BELT CLIP	3-1	FM NARROW	12-3
INSTALLING THE HAND STRAP	3-2	BAR ANTENNA	12-3
CHARGING THE BATTERY PACK	3-2	TX INHIBIT	12-3
BATTERY LIFE	3-3	TIME-OUT TIMER	12-3
CONNECTING TO A CIGARETTE LIGHTER SOCKET	3-3	MICROPHONE SENSITIVITY	12-3
CONNECTING TO A REGULATED POWER SUPPLY	3-3	SETTING RECEIVING FILTERS	12-4
4 GETTING ACQUAINTED	4-1	VOX (VOICE-OPERATED TRANSMISSION)	12-4
KEY AND CONTROL KNOB OPERATIONS	4-1	PITCH FREQUENCY	12-5
DISPLAY	4-3	CW REVERSE	12-5
5 BASIC OPERATIONS	5-1	LED CONTROL	12-6
SWITCHING THE POWER ON/ OFF	5-1	DISPLAY ILLUMINATION	12-6
ADJUSTING THE INTERNAL CLOCK	5-1	POWER ON MESSAGE	12-6
ADJUSTING THE VOLUME	5-1	SINGLE BAND DISPLAY	12-7
VOLUME BALANCE (BAND A/B)	5-1	METER TYPE	12-7
SELECTING DUAL BAND MODE/ SINGLE BAND MODE	5-1	DISPLAY BACKGROUND COLOR	12-7
SELECTING AN OPERATION BAND	5-2	INFORMATION BACKLIGHT	12-8
SELECTING A FREQUENCY BAND	5-2	AUDIO EQUALIZER (TX/RX)	12-8
SELECTING THE DEMODULATION MODE	5-2	KEY BEEP	12-9
SELECTING A FREQUENCY	5-2	BEEP VOLUME	12-9
ADJUSTING THE SQUELCH	5-3	BATTERY SAVER	12-9
TRANSMITTING	5-3	AUTO POWER OFF (APO)	12-9
MONITOR	5-3	BATTERY LEVEL	12-9
FUNCTION SELECT MODE	5-4	CHARGING	12-9
6 MENU MODE	6-1	PROGRAMMABLE FUNCTION KEYS	12-10
MENU ACCESS	6-1	KEY LOCK	12-11
CHARACTER ENTRY	6-1	VOLUME LOCK	12-11
MENU CONFIGURATION	6-2	DISPLAY UNIT	12-11
7 OPERATING THROUGH FM REPEATERS	7-1	OUTPUT DESTINATION INTERFACE (USB/Bluetooth)	12-12
REPEATER ACCESS	7-1	SELECTING A LANGUAGE	12-13
TRANSMITTING A 1750 Hz TONE	7-3	VERIFYING THE FIRMWARE VERSION	12-13
REVERSE FUNCTION	7-3	TRANSCIVER RESET	12-14
8 MEMORY CHANNEL	8-1	13 GPS	13-1
SIMPLEX & REPEATER OR ODD-SPLIT MEMORY CHANNEL?	8-1	BUILT-IN GPS FUNCTION ON/ OFF	13-1
MEMORY CHANNEL LIST	8-1	SETTING MY POSITION DATA	13-1
RECALLING A MEMORY CHANNEL	8-2	MARK FUNCTION	13-4
EDITING MEMORY CHANNEL	8-3	POSITION MEMORY LIST	13-4
CALL CHANNEL MEMORY (SIMPLEX)	8-4	TARGET POINT	13-6
CALL CHANNEL MEMORY (ODD-SPLIT)	8-4	TRACK LOG	13-6
CALL CHANNEL LIST	8-4	14 APRS®	14-1
MEMORY GROUP	8-4	BASIC SETTINGS	14-1
MEMORY SHIFT	8-5	POSITION COMMENT	14-3
9 SCAN	9-1	STATUS TEXT	14-3
SELECTING A SCAN RESUME METHOD	9-1	STATION LIST	14-5
BAND SCAN	9-1	APRS MESSAGE FUNCTIONS	14-9
PROGRAM SCAN	9-2	PROGRAMMING A PACKET PATH	14-11
MHz SCAN	9-2	SETTING INTERNAL TNC	14-12
MEMORY SCAN	9-2	APRS LOCK	14-13
GROUP LINK SCAN	9-3	SETTING TX BEACON	14-13
PRIORITY SCAN	9-4	SETTING BEACON INFORMATION	14-14
CALL SCAN	9-4	OBJECT FUNCTIONS	14-15
SCAN AUTO BACKLIGHT	9-4	QSY FUNCTION	14-16
10 CTCSS/DCS/CROSS TONE	10-1	SETTING SmartBeaconing™	14-17
CTCSS	10-1	SETTING WAY POINT	14-18
DCS	10-2	SETTING PACKET FILTER	14-19
CROSS TONE	10-3	STORING USER PHRASES	14-19
11 DUAL TONE MULTI-FREQUENCY(DTMF)	11-1	STORING AUTO MESSAGE REPLY	14-19
MANUAL DIALING	11-1	SETTING NOTIFICATION SOUND	14-20
AUTOMATIC DIALER	11-1	SETTING DISPLAY	14-21
EchoLink MEMORY	11-2	APRS VOICE	14-21
		SETTING DIGIPEATER	14-21
		PC OUTPUT	14-23

NETWORK	14-23	VOICE MESSAGE MEMORY NAMES	22-2
VOICE ALERT	14-24	CLEARING VOICE MESSAGES	22-3
PROGRAMMING MESSAGE GROUP CODE	14-24	TX MONITORING OF VOICE MESSAGE	22-3
15 BUILT-IN KISS TNC	15-1	23 VOICE GUIDANCE	23-1
KISS MODE OPERATION	15-1	SETTING VOICE GUIDANCE MODE	23-1
16 D-STAR	16-1	24 WEATHER ALERT (TH-D75A ONLY)	24-1
DV MODE/ DR (D-STAR REPEATER) MODE	16-1	WEATHER ALERT ON/ OFF	24-1
MY CALLSIGN	16-1	WEATHER CHANNEL SCAN	24-1
DIGITAL FUNCTION MENU	16-2	25 WIRELESS CONTROL (TH-D75A ONLY)	25-1
SIMPLEX CALL	16-2	PREPARATION	25-1
LOCAL AREA CALL	16-3	CONTROL OPERATION	25-1
GATEWAY CALL	16-4	26 OPTIONS	26-1
REPLY TO THE GATEWAY CALL	16-4	27 MAINTENANCE	27-1
CALLSIGN DESIGNATION	16-4	GENERAL INFORMATION	27-1
CALLSIGN LIST	16-4	SERVICE	27-1
DIRECT REPLY	16-5	SERVICE NOTE	27-1
AUTO REPLY FUNCTION	16-5	CLEANING	27-1
RX HISTORY	16-5	TROUBLESHOOTING	27-2
TX MESSAGES	16-6	28 SPECIFICATIONS	28-1
TX HISTORY	16-6		
CALL WITHIN ZONE	16-6		
SETTING THE ACCESS REPEATER (FROM)	16-7		
SETTING THE ROUTE REPEATER (ROUTE)	16-7		
SETTING THE DESTINATION (TO)	16-7		
CHECKING THE CALLSIGN SETTING	16-8		
DISPLAYING THE REPEATER DETAILS	16-9		
FAST DATA COMMUNICATION	16-9		
EMR COMMUNICATION	16-9		
RX AFC	16-10		
FM AUTO DETECTION ON DV	16-10		
DATA FRAME OUTPUT	16-10		
BK (BREAK) CALL	16-10		
CALLSIGN SQUELCH/ CODE SQUELCH	16-11		
GPS DATA TX MODE	16-11		
RX BREAK-IN DISPLAY	16-12		
CALLSIGN ANNOUNCE	16-12		
STANDBY BEEP	16-13		
DV GATEWAY MODE	16-13		
DR SCAN	16-14		
REPEATER SCAN LOCKOUT	16-14		
REPEATER LIST	16-15		
HOTSPOT LIST	16-16		
17 USB	17-1		
CONNECTING WITH A PC	17-1		
OPERATION SETTING	17-1		
SETTING USB AUDIO OUTPUT LEVEL	17-1		
18 Bluetooth®	18-1		
TURNING ON/ OFF THE Bluetooth FUNCTION	18-1		
CONNECTING BY THE PAIRED DEVICE LIST	18-2		
CONNECTING TO A PC VIA Bluetooth	18-3		
19 microSD MEMORY CARD	19-1		
INSERTING/ REMOVING A microSD MEMORY CARD	19-1		
FORMATTING A microSD MEMORY CARD	19-2		
HOW TO USE A microSD MEMORY CARD	19-2		
LOADING MEMORY DATA	19-2		
CLEARING THE SAVED FILE	19-3		
COMMUNICATION HISTORY (QSO LOG)	19-3		
DISPLAYING THE microSD MEMORY CARD INFORMATION	19-4		
20 RECORDING	20-1		
RECORDING AUDIO FILES	20-1		
OPERATION OF THE AUDIO FILE	20-1		
21 FM RADIO	21-1		
TURNING ON FM RADIO MODE	21-1		
EDITING THE FM RADIO MEMORY CHANNEL LIST	21-1		
22 VOICE MESSAGE MEMORY	22-1		
RECORDING VOICE MESSAGES	22-1		
SENDING VOICE MESSAGES	22-2		

Note:

- ◆ Display examples in this manual may not match the actual operations.

INDEMNITIES

- JVCKENWOOD Corporation takes all appropriate measures to ensure all descriptions in this manual are accurate; however, this manual may still contain typographical errors (“typos”) and expressions that are misleading. JVCKENWOOD Corporation is entirely free from any responsibilities arising from any losses or damages caused by such typos or expressions.
- JVCKENWOOD Corporation has the right to change or improve the product specifications, etc., described in this manual without prior notice. JVCKENWOOD Corporation is entirely free from any responsibilities for any losses or damages caused by such changes and improvements.
- JVCKENWOOD Corporation is entirely free from any responsibilities for any failures, damages or losses arising from, or in connection with, use of the transceiver with or connected to any external equipment.
- JVCKENWOOD Corporation does not warrant that the quality and functions described in this manual comply with your purpose of use and, unless specifically described in this manual, JVCKENWOOD Corporation shall be free from any responsibilities for any defects and indemnities for any damages or losses. Selection and installation of any external equipment shall be done at your own risk. You are fully responsible for the use and effects of external equipment.
- JVCKENWOOD Corporation shall be free from any responsibilities for any incidental losses or damages, such as missing communications or call opportunities caused by a failure or performance error of the transceiver.

Firmware Copyrights

The title to and ownership of copyrights for firmware embedded in KENWOOD product memories are reserved for JVCKENWOOD Corporation.

2 BEFORE STARTING

Thank You

We are grateful you decided to purchase this **KENWOOD** Digital transceiver.

The models listed below are covered by this manual.

TH-D75A: 144/220/430MHz Tribander (The Americas)

TH-D75E: 144/430MHz Dual Bander (E type: Europe/ T type: UK)

Firmware Version 1.00 or later.(The firmware version can be verified in Menu No.991.)

Features

This transceiver has the following main features:

- Includes a program for dealing with data formats supported by Automatic Packet Reporting System (APRS®).
 - Supports APRS® Digipeater function.
- Compliant with voice/digital mode D-STAR digital amateur radio networks.
 - Supports with D-STAR 2-wave simultaneous reception.
 - Supports Reflector Terminal mode.
- Built-in GPS receiver unit.
- Transflective color TFT Display.
- Weatherproof toughness to IP 54/55 standard.
- Wide-band and multi-mode reception.
- Two-wave simultaneous reception. (VxU, UxV, UxU (TH-D75A/ TH-D75E), Vx220M, 220MxV, Ux220M (TH-D75A))
- Equipped with IF filter for comfortable reception (SSB/CW/AM).
- High-performance DSP-based voice processing.
- Built-in Bluetooth (SPP, HSP)
- microSD memory card (2 GB to 32 GB)
- Compliant with the battery charge as well as data transmission and reception by USB Type-C™.
- 1000 memory channels, 1500 repeater lists and 30 hotspot lists.
- Transmit power 4-step switching (5/ 2/ 0.5/ 0.05 W)

Writing Conventions Followed in this Manual

The writing conventions described below have been followed to simplify instructions and avoid unnecessary repetition.

Instruction	Action
Press [KEY].	Momentarily press KEY.
Press and hold [KEY] .	Press KEY until activated.
Press [KEY1], [KEY2].	Press KEY1 momentarily, release KEY1, then press KEY2.
Press [F], [KEY].	Press the F key to enter Function mode, then press KEY to access its secondary function.
Press [KEY] + Power ON.	With the transceiver power OFF, press and hold KEY while turning the transceiver power ON.

3 PREPARATION

SUPPLIED ACCESSORIES

After carefully unpacking the transceiver, identify the items listed in the table below. We recommend you keep the box and packaging for shipping.

Item	Comments	Quantity		
		TH-D75A	TH-D75E	T
Antenna		1	1	1
Li-ion battery pack	KNB-75LA: 1820 mAh	1	1	1
Charger (AC Voltages: 100 - 240 V, 50/60 Hz)	W0H-0160-XX	1	-	-
	W0H-0161-XX	-	1	-
	W0H-0162-XX	-	-	1
Belt clip	2 screws supplied	1	1	1
Warranty card		1	1	1
User guide	English/ French/ Spanish	1	1	1
	Italian/ German/ Dutch	-	1	-

INSTALLING THE ANTENNA

Hold the supplied antenna by its base, then screw it into the connector on the top panel of the transceiver until secure.

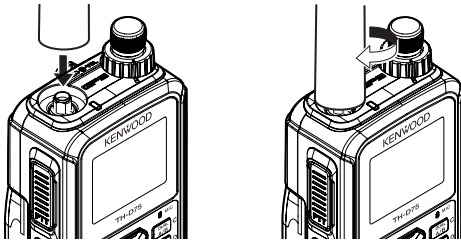

INSTALLING THE BATTERY PACK

Note:

- ◆ Because the battery pack is provided uncharged, you must charge the battery pack before using it with the transceiver.
- ◆ When removing the battery pack, be careful not to drop the transceiver and the battery pack.
- ◆ When installing/removing the battery pack, be careful not to damage your nails or fingers.
- ◆ Never leave the battery pack in direct sunlight to prevent accidents due to overheating.

Match the guides of the battery pack with the corresponding grooves on the upper rear of the transceiver, then firmly press the battery case to lock it in place.

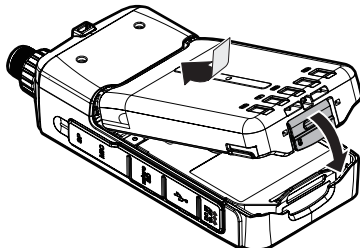

To remove the battery pack, lift the release lever to unlock the battery pack. Lift the battery pack away from the transceiver.

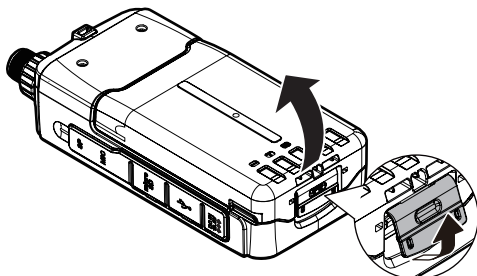

INSTALLING ALKALINE BATTERIES

- 1 To open the optional KBP-9 battery case lid, press the release lever on the top of the battery case, then pull the cover up.

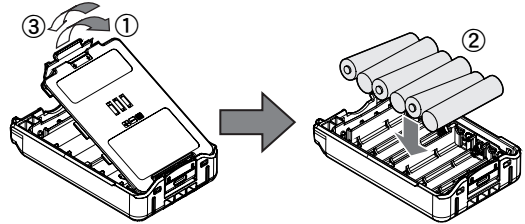

- 2 Insert (or remove) six AAA (LR03) Alkaline batteries.
 - When removing the Alkaline batteries from the battery case, pull up on the batteries from the positive (+) terminal.
 - Be sure to match the battery polarities with those marked in the bottom of the battery case.
- 3 Align the two tabs at the bottom of battery case, then close the cover until the locking tabs on top click.
- 4 To install the battery case onto (or remove it from) the transceiver, follow "INSTALLING THE BATTERY PACK".

Note:

- ◆ Do not use Manganese batteries or Rechargeable batteries in place of Alkaline batteries.
- ◆ Remove all batteries from the case when it is not expected to be in use for several months.
- ◆ To lift the battery pack safety catch, use a piece of hardened plastic or metal, such as a screwdriver, that is no more than 6 mm wide and 1 mm thick. It is imperative that you place the implement under only the lip of the safety catch so that you do not damage the release latch.

INSTALLING THE BELT CLIP

If desired, you can install the supplied belt clip to the transceiver.

Without the battery pack or battery case installed, attach the belt clip firmly using the two supplied M3 x 6 mm binding screws.

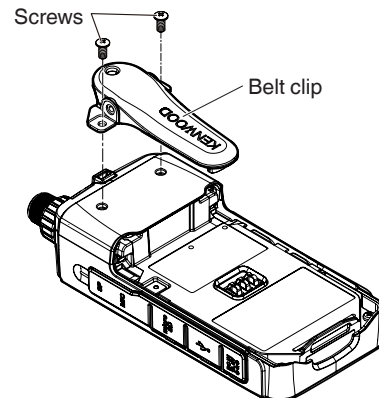

Note:

- ◆ Be sure to use the screws supplied with the belt clip.
- ◆ If a battery pack or battery case is installed, the screws may not be tightened properly due to the tilt of the metal plate of the belt clip.
- ◆ Be careful not to pinch your fingers into the belt clip.
- ◆ Check occasionally to see if the screws are loose.



CAUTION

- Do not use glue which is designed to prevent screw loosening when installing the belt clip, as it may cause damage to the transceiver. Acrylic ester, which is contained in these glues, may crack the transceiver's back panel.

INSTALLING THE HAND STRAP

If desired, you can install the commercially available strap with sufficient strength using the holes of the transceiver.

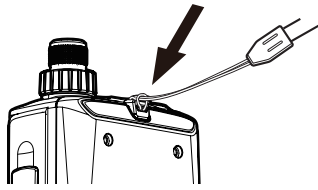

Note:

- ◆ If the strap is thick and does not pass through the holes, install the strap using the holes of the supplied belt clip.

CHARGING THE BATTERY PACK

For charging the battery pack with the supplied battery charger

The battery pack can be charged after it has been installed onto the transceiver. (The battery pack is provided uncharged for safety purposes.)

- 1 Plug the charger into an AC wall outlet.
- 2 Insert the charger plug into the DC IN jack of the transceiver while the transceiver power is OFF.

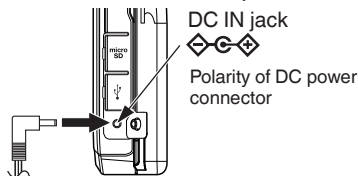

- Charging starts and indicator appears on the display when the transceiver power is OFF. indicator disappears when charging is completed.
 - The backlight is ON when pressing any key while charging.
 - "Charging" does not appear when charging with the optional rapid battery charger.
- 3 It takes approximately 3.5 hours to charge an empty KNB-75LA Li-ion battery pack (charging when the transceiver power is OFF). After the charging period is over, remove the charger plug from the transceiver DC IN jack.
 - Do not plug the charger into the DC IN jack for more than 24 hours.
 - Charging when the transceiver power is ON takes a longer time than charging when the transceiver power is OFF.
 - 4 Unplug the charger from the AC wall outlet.

Note:

- ◆ Do not transmit while the supplied charger is connected. The supplied charger is only for charging and does not have the current capacity required for transmission. Accidental transmission may cause a sudden voltage drop, resulting in malfunction or failure. When connecting the supplied charger while the transceiver is turned ON, turn off the automatic transmission functions such as APRS and D-STAR automatic response to prevent accidental transmission.
- ◆ The supplied charger is a switching type. Receiving noise level may increase while connected to the transceiver, especially in AM/SSB/CW mode.
- ◆ The transceiver becomes warm while charging the battery pack.
- ◆ While the battery pack is charged, the ambient temperature must be within 0°C ~ 40°C (32°F ~ 104°F). Otherwise, charging does not start. If the transceiver senses that the temperature is more than 60°C (140°F) during charging, the transceiver stops charging.
- ◆ Before recharging the battery pack, use the battery pack until the transceiver stops receiving.

- ◆ Do not expose the charger to dripping or splashing conditions. No objects filled with liquids, such as vases, shall be placed on the AC adapter or charger.
- ◆ Do not place the charger into the liquids.
- ◆ The charger plug for an AC wall outlet should be used to disconnect an AC adapter from an AC outlet, and the charger plug must remain readily operable.
- ◆ After the battery pack is charged, do not unplug and plug the charger into the AC outlet again. Unplugging the charger will reset the charging timer and the battery pack will be charged again. This could result in over-charging.
- ◆ If the battery pack is not used for a long time, the battery pack capacity temporarily decreases. In this case, charge the battery and use the battery pack until the transceiver stops receiving. Repeat this procedure several times. The battery pack should recover its capacity.
- ◆ Exceeding the specified charge period shortens the useful life of the KNB-75LA battery pack.
- ◆ When not in use, store the battery pack in a cool and dry place.
- ◆ Before charging the battery pack, ensure that the release lever is firmly closed.
- ◆ Attention should be drawn to the environmental aspects of battery disposal.
- ◆ It takes approximately 3 hours to charge the KNB-75LA with the optional rapid battery charger.
- ◆ Charging through the DC IN jack and USB connector when the transceiver is turned ON can be disabled to prevent unexpected malfunctions or failures caused by operation during charging. Access Menu No. 923.

For charging the battery pack with the USB cable (USB Type-C™)

- 1 Plug the USB cable into an AC adapter, etc.
- 2 Attach the battery pack to the transceiver, and plug the USB plug into the USB connector while the transceiver power is OFF.

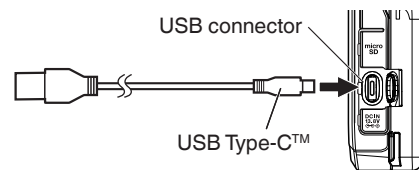

Note:

- ◆ The maximum charging current through the USB connector of the transceiver is 1.5A. To avoid malfunction or abnormal heat generation, be sure to use an AC adapter with an output voltage of 5V and a current of 2A or higher. In this case, the charging time will be approximately 5.5 hours.
- ◆ The transceiver does not support USB PD. Even if a USB PD compatible AC adapter is used, the voltage supplied will always be 5V. Rapid charging through the USB connector is not possible.
- ◆ When charging through the USB connector, be sure to turn the power OFF. If the power is ON, the battery pack will not receive enough charging current.
- ◆ Do not use a USB cable longer than 3m (9.8feet).
- ◆ Charging through the USB connector is not guaranteed to work with all AC adapters or USB cables.
- ◆ Charging through the DC IN jack and USB connector when the transceiver is turned ON can be disabled to prevent unexpected malfunctions or failures caused by operation during charging. Access Menu No. 923.
- ◆ If both the DC IN cable and the USB cable are connected, you cannot charge using the USB cable. The DC IN route has priority.
- ◆ The transceiver will not operate properly if DC power is supplied only through the USB connector. Be sure to use the transceiver with the battery pack installed.

For charging the battery pack with the optional rapid battery charger

Note:

- ◆ Insert the battery pack only in the rapid battery charger to charge a battery pack that has been in storage for a long time.
- ◆ If the battery pack is completely depleted while using the transceiver, remove the battery pack from the transceiver and insert the battery pack in the rapid battery charger.
- ◆ When the battery is installed on the transceiver and you are using an optional rapid battery charger, do not charge the battery from the DC IN jack/ USB connector. Charging the battery from the DC IN jack/ USB connector may result in overcharging the battery which can result in the shortening of the battery life cycle.

Charger Error

- While charging, if a problem is detected in the battery, "Charge Error !!" appears on the display.
- The following condition create charging error:
Overvoltage in the battery is detected.
- When a charge error occurs, no key other than [⏻] will function.

BATTERY LIFE

Before you operate the transceiver outside using a battery pack, it is important to know how long the battery pack will last.

If the battery saver setting is 1.0 sec and the GPS setting is Off in the single band operation, the operating times listed in the table below are the referential values under the following cyclic conditions: TX: 6 seconds, RX: 6 seconds, Stand-by: 48 seconds

We recommend you carry extra battery packs with you, in case the battery pack becomes depleted.

Battery Type	Output Power	Operating Time/ Hours (Approx.)
KNB-75LA Li-ion battery pack	H	6
	M	8
	L	12
	EL	15
KBP-9 Battery case	H	-
	M	-
	L	3.5
	EL	-

CONNECTING TO A CIGARETTE LIGHTER SOCKET

To connect the transceiver to the cigarette lighter socket in your vehicle, use an optional PG-3J Cigarette Lighter cable.

When the PG-3J is connected to the cigarette lighter plug, the transceiver automatically starts charging the battery pack. While you operate the transceiver, it charges the battery pack in the background.

Note:

- ◆ To connect with an external 24 V power source via a DC-DC converter, only use the optional PG-3J Cigarette Lighter cable.
- ◆ Using the PG-2W DC cable in this situation may cause a fire.

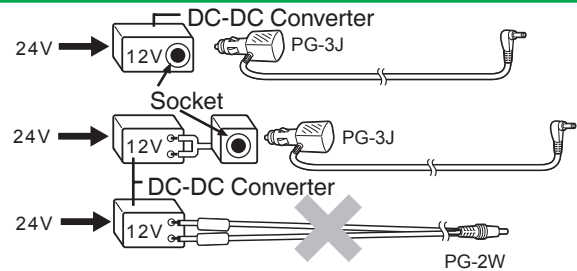

Note:

- ◆ Do not use the PG-2W to connect directly to a vehicle battery (12 V). Extensive voltage could result in damaging the transceiver.
- ◆ If the input voltage exceeds approximately 17.5 V, the transceiver automatically turns OFF.

CONNECTING TO A REGULATED POWER SUPPLY

To connect the transceiver to an appropriate regulated DC power supply, use an optional PG-2W DC cable.

- 1 Confirm that the power of both the transceiver and the DC power supply is OFF.
- 2 Connect the optional PG-2W DC cable to the DC power supply; the red lead to the positive (+) terminal, and the black lead to the negative (-) terminal.

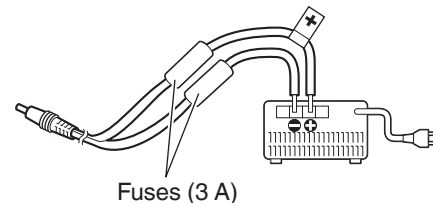

- 3 Connect the barrel plug on the DC cable to the DC IN jack of the transceiver.
 - While a DC power supply is connected with the DC IN jack, the transceiver automatically initiates charging the battery pack.

Caution:

- ◆ Install a lithium-ion battery pack or battery case when a DC Power Supply is used. Failure to do so may result in burns.

Note:

- ◆ The supply voltage must be between 11 V and 15.9 V to prevent damaging the transceiver. If the input voltage exceeds approximately 17.5 V, the transceiver automatically turns OFF.

4 GETTING ACQUAINTED

KEY AND CONTROL KNOB OPERATIONS

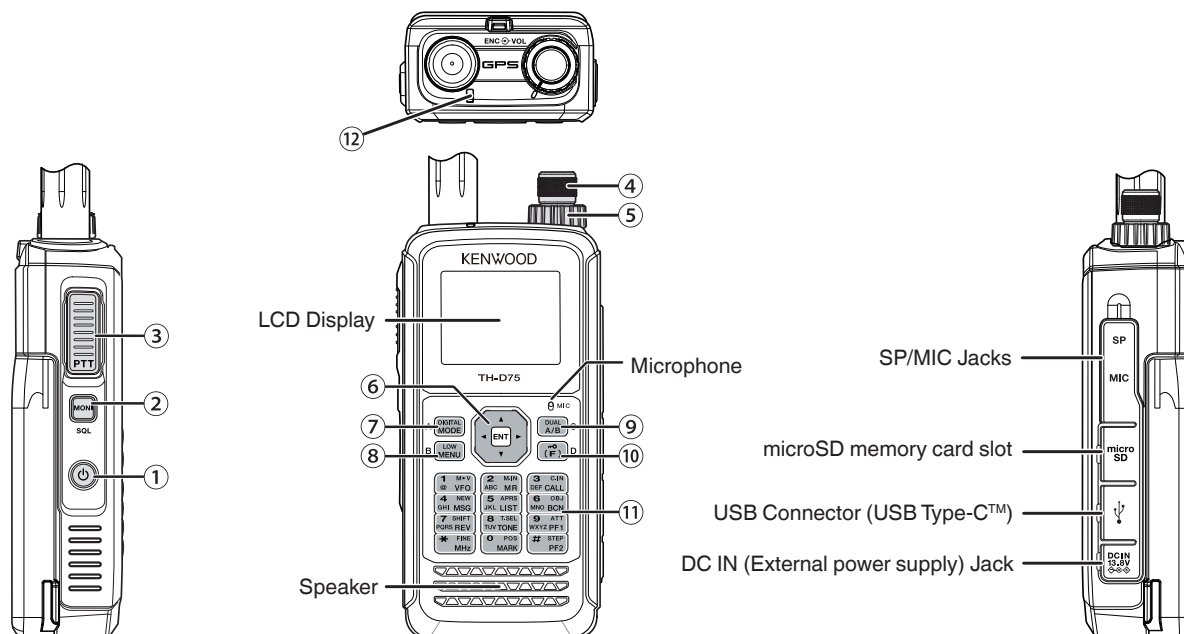

① [PWR]

Press and hold [PWR] to turn the transceiver power ON and OFF.

Press [PWR] to turn the backlight ON and OFF when the transceiver power is ON.

The backlight turns OFF when the backlight timer elapses.

When the voice guidance function is not set to OFF, the voice announces the operating states of the transceiver.

When pressing [PWR] while announcing, the voice stops.

② [MONI]

Press and hold [MONI] to unmute the speaker in order to monitor signals.

Release [MONI] to return to normal operation.

Press [F], [MONI] to enter squelch threshold level adjustment mode.

③ [PTT]

Press and hold [PTT], then speak into the microphone to transmit.

④ ENC Control

Rotate the ENC control to select an operating frequency, Memory channel, Menu item, setting value and change the scan direction, etc.

⑤ VOL Control

Rotate the VOL control to adjust the speaker volume.

⑥ Multi-Scroll Key

[▲], [▼]

Press [▲] or [▼] to select an operating frequency, Memory channel, Menu item, setting value or to change the scan direction, etc.

Press and hold [▲] or [▼] to change an operating frequency, Memory channel, Menu item, setting value, etc. continuously.

[▶]

Press and hold [▶] to select a frequency band in VFO mode.

Press [▶] to move to the next step in various setting modes.

[◀]

Press and hold [◀] to select a frequency band in VFO mode.

Press [◀] to move back to the previous step in various setting modes.

[ENT]

Press [ENT] to enter frequency direct entry mode in VFO mode.

Press [ENT] to complete the setting value and move to the next step in Menu mode or various setting modes.

⑦ [MODE]

Press [MODE] to select the mode.

Press [F], [MODE] in DV mode or DR mode to enter Digital Function menu mode.

This key operates the function displayed in the lower left side.

⑧ [MENU]

Press [MENU] to enter Menu mode.

Press [F], [MENU] to cycle the transmit output power.

⑨ [A/B]

Press [A/B] to select operation band A or B.

Press [F], [A/B] to switch the Single band mode and Dual band mode.

This key operates the function displayed in the lower right side.

⑩ [F]

Press [F] to enter Function select mode.

Press and hold [F] to turn the transceiver Key lock function ON and OFF.

⑪ 12 Keypad

[VFO] (1)

Press [VFO] to enter VFO mode. In Memory channel or CALL channel, press [F], [VFO] to copy the current Memory channel or Call channel to the VFO (memory shift).

[MR] (2)

Press **[MR]** to enter Memory Channel mode.

Press **[F]**, **[MR]** to move to the Memory channel store screen.

[CALL] (3)

Press **[CALL]** to select the Call channel.

Press **[F]**, **[CALL]** to store the displayed operating frequency to the Call channel.

[MSG] (4)

Press **[MSG]** to display the APRS Message list.

Press **[F]**, **[MSG]** to enter the New Message input mode.

[LIST] (5)

Press **[LIST]** to display the APRS Station list.

- Each time you press **[F]**, **[LIST]**, the mode cycles through the following: APRS mode ON → KISS mode ON → OFF.

[BCN] (6)

Press **[BCN]** to transmit the beacon when APRS mode is ON.

Press **[F]**, **[BCN]** to transmit the Object.

[REV] (7)

Press **[REV]** to turn the Reverse function ON or OFF.

Press **[F]**, **[REV]** to select the Shift direction.

[TONE] (8)

Press **[TONE]** to turn the Tone function ON.

- Each time you press **[TONE]**, the function cycles through the following: Tone ON → CTCSS ON → DCS ON → Cross Tone ON → OFF.

Press **[F]**, **[TONE]** to enter the Tone frequency, CTCSS frequency, DCS code, or Cross Tone setup mode.

Press **[F]**, press and hold **[TONE]** to start the Tone frequency, CTCSS frequency, or DCS code scan.

[PF1] (9)

Press **[PF1]** to activate its programmed function.

Press **[F]**, **[PF1]** to turn the Attenuator function ON or OFF.

[MARK] (0)

Press **[MARK]** to display the Position memory list.

Press and hold **[MARK]** to enter the Mark Way point registration mode.

Press **[F]**, **[MARK]** display your "My position".

[MHz] (✳)

Press **[MHz]** to enter the MHz mode.

Press and hold **[MHz]** to start the MHz scan.

Press **[F]**, **[MHz]** to enter Fine tuning function mode.

[PF2] (#)

Press **[PF2]** to activate its programmed function.

Press **[F]**, **[PF2]** to enter Frequency step setup mode or Fine step frequency setup mode.

⑫ ON AIR/ Busy Indicator

The indicator lights red in transmitting, and lights green in receiving.

The indicator lights blue in transmitting in the reflector terminal mode.

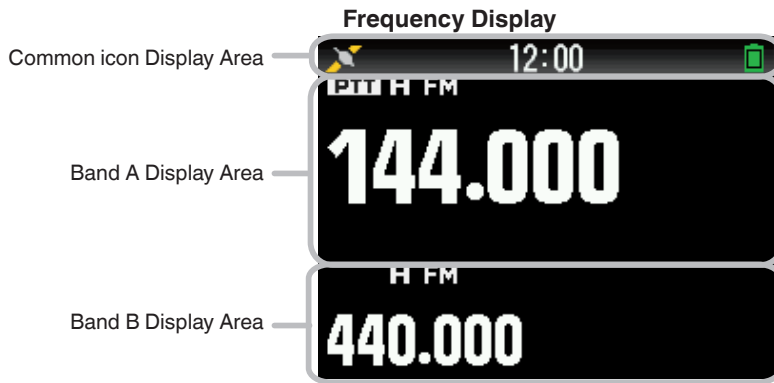

Various function indicator

Indicator	Description	Page
	Performs as the S meter when receiving a signal.	12-7
	Displays the selected power level while transmitting.	5-3
PTT	Indicates the transmission band.	5-2
EL	Appears while using Economic low output power.	5-3
L	Appears while using Low output power.	5-3
M	Appears while using Medium output power.	5-3
H	Appears while using High output power.	5-3
FM	Appears while in FM mode.	5-2
NFM	Appears while in Narrow FM mode.	12-3
WFM	Appears while in Wide FM mode.	21-1
AM	Appears while in AM mode.	5-2
LSB	Appears while in LSB mode.	5-2
USB	Appears while in USB mode.	5-2
CW	Appears while in CW mode.	5-2
DR	Appears while in Digital Repeater mode.	16-1
DV	Appears while in Digital Voice mode.	16-1
VA	Appears when Voice Alert is set to "ON".	14-24
VAR	Appears when Voice Alert is set to "RX Only".	14-24
T	Appears when the Tone function is ON.	7-2
CT	Appears when the CTCSS function is ON.	10-1
DCS	Appears when the DCS function is ON.	10-2

Indicator	Description	Page
T/C	Appears when the Cross tone function is "TONE/CTCSS".	10-3
D/C	Appears when the Cross tone function is "DCS/CTCSS".	10-3
T/D	Appears when the Cross tone function is "TONE/DCS".	10-3
D/O	Appears when the Cross tone function is "DCS/OFF".	10-3
+	Appears when the Shift function is set to plus.	7-3
-	Appears when the Shift function is set to minus.	7-3
	Appears when the Shift function is set to -7.6 MHz. (TH-D75E only)	7-3
R	Appears when the Reverse function is ON.	7-3
ATT	Appears when the Attenuator function is ON.	12-1
APRS 12	Appears when the packet communication speed in APRS mode is set to 1200 bps.	14-12
APRS 96	Appears when the packet communication speed in APRS mode is set to 9600 bps.	14-12
KISS 12	Appears when the packet communication speed in KISS mode is set to 1200 bps.	15-1
KISS 96	Appears when the packet communication speed in KISS mode is set to 9600 bps.	15-1
STA	Appears while in Stand-by (Packet mode).	15-1
BCON	Appears when the Beacon function is ON.	14-13
OBJ	Appears when the Object function is ON.	14-15
	Appears when the built-in GPS function is ON and positioning.	13-1
	Appears when the built-in GPS function is ON and not positioning.	13-1

Menu Mode Display

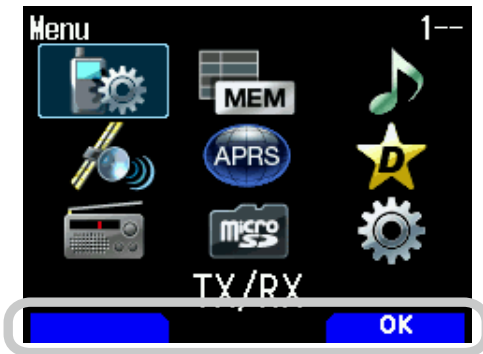

D-STAR (DV/DR mode) Display

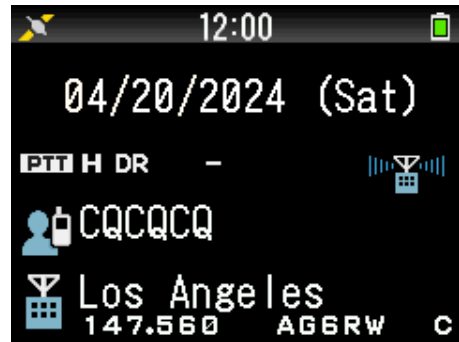

KEY GUIDE Display Area

Indicator	Description	Page
	Appears when the GPS Track Log function is ON and the built-in GPS function is positioning.	13-6
	Appears when the GPS Track Log function is ON and the built-in GPS function is not positioning or in Save mode.	13-6
	Appears when a message is received.	14-9
	Appears when recording communication.	20-1
	Appears when recording a voice message is paused.	20-1
	Appears when the Priority Scan function is ON.	9-4
	Appears when FM radio mode is ON.	21-1
	The Bluetooth® function is ON.	18-1
	Connected to a Bluetooth® device.	18-1
	Appears when a microSD memory card is recognized. Blinks when a microSD memory card is mounting.	19-1
	Appears when Weather Alert is ON. Blinks when Weather Alert is detected. (TH-D75A only.)	24-1
	Appears when the key lock is ON.	12-11
	Indicates the battery level.	12-9
	Appears during charging of the battery.	3-2
	Indicates the memory group number.	8-4
	Indicates the Weather Channel. (TH-D75A only.)	24-1

Indicator	Description	Page
	Appears when the Memory Channel Lockout function is ON.	9-3
	Appears when the Repeater Lockout function is ON.	16-14
	Appears when Callsign squelch is ON.	16-11
	Appears when Code squelch is ON.	16-11
	TX: Appears in interrupt communication. RX: Blinks while receiving interrupt communication.	16-10
	Appears when the auto reply function is ON.	16-5
	Appears in GPS transmission.	16-11
	Appears while in data communication mode. Blinks while receiving fast data.	16-9
	Appears when a packet loss happens.	27-2
	Indicates a repeater for local area call.	16-3
	Indicates a repeater for call within zone.	16-6
	Indicates a repeater for gateway call.	16-4
	Appears while in the reflector terminal mode.	16-13

5 BASIC OPERATIONS

SWITCHING THE POWER ON/ OFF

Switching the Power ON

Press and hold [PWR].

The power on message momentarily appears, and frequency screen appears.



Switching the Power OFF

Press and hold [PWR].

ADJUSTING THE INTERNAL CLOCK

The default setting of the built-in GPS function is [On].

When you turn on the power, the built-in GPS receiver will start positioning after a while, and "GPS Locked" will be appear on the display.

After that, the <GPS> indicator will change to <GPS> indicator and the time and date information will be automatically set.

If the GPS information cannot be received, you can manually enter the date and time.

1 Access Menu No. 950.

Date & Time screen appears by pressing [MENU], [PF1], [LIST], [MARK].

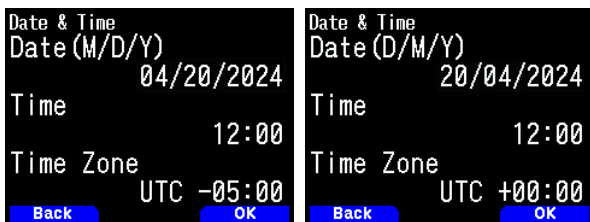

2 Set the date, time, and time zone with [▲]/[▼] or [ENC] control.

3 Press [A/B].

The date, time, and time zone are set.

4 Press [MENU] to return to the frequency screen.

Note:

- ◆ "GPS Locked" appears on the display only when you turn on the power or turn on the GPS function and start positioning for the first time.
- ◆ The GPS icon on this transceiver does not flush.
- ◆ If there is no voltage supplied from the battery pack, DC IN jack, or USB connector, date and time information is retained by the built-in lithium battery for approximately one week, and then cleared.
- ◆ If you turn on the power after the date and time information has been cleared and do not perform acquisition using the built-in GPS receiver or manual settings, the built-in clock will return to the default date and time as shown below. (Initial values may change due to firmware updates.)
Date: 01/01/2024
Time: 00:00

ADJUSTING THE VOLUME

Rotate the VOL control to increase the volume and counterclockwise to decrease the volume.

When no sound is heard (the squelch is closed), you can adjust the noise level by rotating the VOL control while pressing the [MONI].

- To change the volume of the beep that sounds when you press a key. (refer to page No. 12-9)
- To change the volume of voice guidance. (refer to page No. 23-1)

VOLUME BALANCE (BAND A/B)

This function adjusts the volume balance when using the transceiver with dual bands.

1 Access Menu No. 910.

Volume balance screen appears by pressing [MENU], [PF1], [VFO], [MARK].

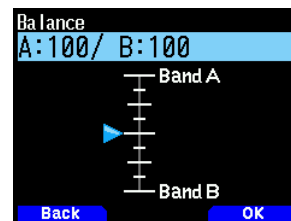

2 Change the balance with [▲]/[▼] or [ENC] control.

- Band A and B are set to the same volume level (MAX) as a default setting. Pressing [MODE] returns to the previous screen without changing the setting.

When you select [Operation Band Only], the sound of the operation band is outputted with priority.

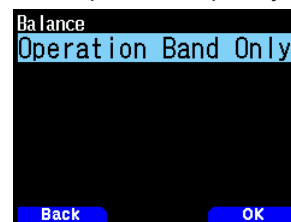

Setting examples

When used in combination with APRS:

When using band A for voice calls, use the transceiver with the sound of band B set to a low volume level or muted.

When simultaneously scanning two waves:

If [Operation Band Only] is set, a voice is output only for the operation band when the operation and non-operation band become busy at the same time.

3 Press [ENT] to set the volume balance.

4 Press [MENU] to return to the frequency screen.

SELECTING DUAL BAND MODE/ SINGLE BAND MODE

You can switch the transceiver between dual band operation and single band operation.

1 Press [F], [A/B].

- Each time you press [F], [A/B], the transceiver switches between Single band and Dual band mode.

Dual Band mode

Single Band mode



SELECTING AN OPERATION BAND

You can select a band A or B as an operation band for changing the frequency or setting various operations, etc.

- 1 Press **[A/B]** to select operating band A or B.

Dual Band A

Dual Band B



Single Band A

Single Band B



SELECTING A FREQUENCY BAND

You can change the frequency bands for bands A and B.

- 1 Press and hold **[◀]/[▶]**.
 - Each time you press and hold **[◀]/[▶]**, you cycle to the next frequency band.

Band A : 144 ⇄ 220 ⇄ 430 ⇄ 144 (MHz).

Band B : 430 ⇄ UHF(470-524) ⇄ LF/MF(AMBC) ⇄ HF ⇄ 50 ⇄ FMBC ⇄ 118 ⇄ 144 ⇄ VHF(174-216) ⇄ 200/300 ⇄ 430 (MHz).

Note:

- ◆ 220 MHz band in Band A is used by the TH-D75A only.

Frequency ranges:

- 118 MHz: Band B 108 ~ 136 MHz
- 144 MHz: 136 ~ 174 MHz
- VHF: 174 ~ 216 MHz (TH-D75A)
174 ~ 230 MHz (TH-D75E)
- 220 MHz: 216 ~ 260 MHz (TH-D75A only)
- 200/300 MHz: Band B 216 ~ 410 MHz (TH-D75A)
230 ~ 410 MHz (TH-D75E)
- 430 MHz: 410 ~ 470 MHz
- UHF: 470 ~ 524 MHz
- LF/MF(AMBC): 0.1 ~ 1.71 MHz
- HF: 1.71 ~ 29.7 MHz
- 50: 29.7 ~ 76 MHz
- FMBC: 76 ~ 108 MHz

SELECTING THE DEMODULATION MODE

You can select the demodulation mode.

- 1 Press **[A/B]** to select an operation band.
- 2 Press **[MODE]** to select a demodulation mode.
 - Each press changes the demodulation mode as follows.

Band A: FM/NFM → DR (DV) → (Returns to FM/NFM)

Band B: FM/NFM → DR (DV) → AM → LSB → USB → CW → (Returns to FM/NFM)

Note:

- ◆ Switching between the DV and DR modes is not possible with the **[MODE]** button. (Refer to “Digital Function Menu”.)
- ◆ Switching between the FM and NFM modes is not possible with the **[MODE]** button.

SELECTING A FREQUENCY

There are 3 operating modes available to choose from: VFO mode, Memory Channel mode, and Call Channel mode.

VFO Mode

VFO mode allows you to manually change the operating frequency.

- 1 Press **[VFO]** to enter VFO mode.
- 2 Rotate the **[ENC]** control to select your desired operating frequency.
 - You can also select a frequency by using the **[▲]/[▼]** keys.
 - The default step frequency for the **[ENC]** control varies according to the model and operating frequency band:

Model	144 MHz	220 MHz	430 MHz
TH-D75A	5 kHz	20 kHz	25 kHz
TH-D75E	12.5 kHz	-	25 kHz

Note:

- ◆ 220 MHz band is used by the TH-D75A only.

MHz Step

To adjust the frequency by a larger amount, press **[MHz]** to enter MHz mode, then rotate the **[ENC]** control or use the **[▲]/[▼]** keys to adjust the frequency in steps of 1 MHz. Press **[MHz]** again to exit MHz mode and adjust the frequency using the normal step frequency.

Frequency Direct Entry

If the desired operating frequency is far from the current frequency, using the keypad is the quickest way to change the frequency.

- 1 Press **[ENT]**.
The Direct Frequency Entry display appears.
- 2 Press the numeric keys (**[0] ~ [9]**) to enter your desired frequency.
- 3 To set the entered frequency, press 6 digit.
 - Pressing **[ENT]** before entering all of the digits will set the remaining digits to 0.

Memory Channel Mode

Memory Channel mode allows you to quickly select a frequently used frequency and related data which you have stored in the memory channel.

- 1 Press **[MR]** to enter Memory Channel mode.
The Memory channel number appears on the display.
- 2 Press **[▲]/[▼]** or rotate the **[ENC]** control to select the memory channel.
Press **[▲]** or rotate the **[ENC]** control clockwise to call up the memory channel with the higher number, and press **[▼]** or rotate the **[ENC]** control counterclockwise to call up the memory channel with the lower number.
Display the memory channel number you want to recall.
Press **[VFO]** to return to frequency display (VFO mode).

Call Channel Mode

Call Channel mode allows you to quickly select a preset channel to allow immediate calls on that frequency. The Call channel can be conveniently used as an emergency channel within your group.

- 1 Press **[CALL]** to enter Call Channel mode.
“C” appears on the display.
- 2 Press **[CALL]** again, and the transceiver will return to the previous frequency.
 - The default settings are as follows.

TH-D75A

Band (Mode)	Call Channel	Memory Name
VHF (except DV/DR mode)	146.520 MHz (FM)	Call VHF (FM)
VHF(DV/DR mode)	144.000 MHz (DV)	Call VHF (DV)
220 MHz(except DV/DR mode)	223.500 MHz (FM)	Call 220M (FM)
220 MHz(DV/DR mode)	223.000 MHz (DV)	Call 220M (DV)
UHF(except DV/DR mode)	446.000 MHz (FM)	Call UHF (FM)
UHF(DV/DR mode)	440.000 MHz (DV)	Call UHF (DV)

TH-D75E

Band (Mode)	Call Channel	Memory Name
VHF (except DV/DR mode)	145.500 MHz (FM)	Call VHF (FM)
VHF(DV/DR mode)	144.8125MHz (DV)	Call VHF (DV)
UHF(except DV/DR mode)	433.500 MHz (FM)	Call UHF (FM)
UHF(DV/DR mode)	433.6125MHz (DV)	Call UHF (DV)

ADJUSTING THE SQUELCH

Squelch is used to mute the speaker when no signals are present. With the squelch level set correctly, you will hear sound only while actually receiving a signal. The higher the squelch level selected, the stronger the signals must be in order to hear them. You can set the squelch level separately for Bands A and B.

- 1 Press **[F]**, **[MONI]**.
The squelch level appears on the display.

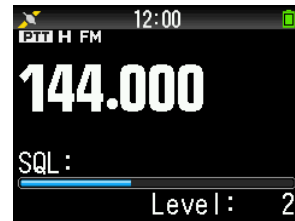

- 2 Press **[▲]/[▼]** or rotate the **[ENC]** control of your selected band, when no signals are present, and select the squelch level at which the background noise is just eliminated.
- 3 Press **[ENT]**.
The squelch level is set.

TRANSMITTING

- 1 Select your desired band and frequency/channel.
- 2 Press and hold **[PTT]**, and speak into the microphone to transmit.

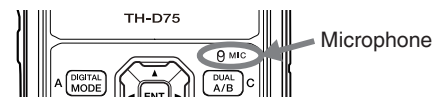

- 3 When you finish speaking, release the **[PTT]**.

Selecting an Output Power

Selecting a lower transmit power is the best way to reduce battery consumption, if communication is still reliable.

Press **[F]**, **[MENU]** to select high (H), medium (M), low (L), or economic low (EL) power.

Battery Pack KNB-75LA	H	Approx. 5 W
Battery Case KBP-9 (AAA Alkaline batteries)	M	Approx. 2 W
	L	Approx. 0.5 W
External Power Supply	EL	Approx. 0.05 W

Note:

- ◆ You can program different power settings for bands A and B.
- ◆ You can not change the output power in transmitting.
- ◆ You can not set the output power in each frequency band.

MONITOR

When you are receiving while the squelch function is ON, weak signals may become intermittent.

- 1 Press and hold **[MONI]**.
 - The speaker is unmuted and you can monitor the signals.
- 2 Release **[MONI]** to return to normal operation.

FUNCTION SELECT MODE

Press **[F]** to enter Function Select mode. Press **[F]** again to return to the previous screen.

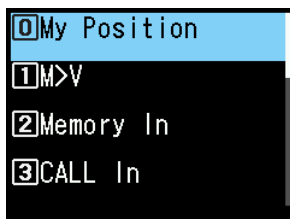

Pressing each key in the function select mode performs the operation of the second function assigned to each key.

The function of each key may differ depending on the mode when **[F]** is pressed (refer to the following table).

Key	Second function	Remarks
[MARK] (0)	My position	Built-in GPS is On.
[VFO] (1)	Memory shift	Only in Memory mode or Call mode
[MR] (2)	Memory channel registration	
[CALL] (3)	Call channel registration	
[MSG] (4)	APRS message creation	
[LIST] (5)	APRS/ KISS mode switching	
[BCN] (6)	Object beacon	Only in APRS mode
[REV] (7)	Shift	
[TONE] (8)	Tone frequency	
[PF1] (9)	Attenuator	
[MHz] (*)	Fine mode	
[PF2] (#)	Frequency Step	
[MODE]	Digital function menu	Only in DV/DR mode
[MENU]	Transmission power	
[A/B]	Dual or Single band switching	
[F]	Function select mode end	
[MONI]	Squelch setting	

Note:

- ◆ The tone frequency changes to the following setting items depending on the conditions of this transceiver.
 Tone OFF: Invalid
 Tone ON: Tone frequency
 CTCSS ON: CTCSS frequency
 DCS ON: DCS frequency
 Cross Tone ON: Cross tone combination

6 MENU MODE

Many functions on this transceiver are selected or configured through the Menu instead of physical controls.

MENU ACCESS

Example: Setting the time for [Battery Saver] of Menu No. 920.

- 1 Press **[MENU]**.

The transceiver enters the Menu mode. The icon currently selected by the cursor is highlighted, and the item name is displayed at the bottom of the screen. (Example: TX/RX)

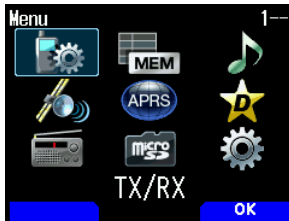

Directly Entering a Menu Number (Direct Access)

You can also directly enter a menu number using the number keys from this screen.

Press **[PF1]**, **[MR]**, **[MARK]** for Menu No.920. In this case, you can move to step 4.

- 2 Select [Configuration] with **[▲]/[▼]** or **[ENC]** control and press **[A/B]**.



- 3 Select [Battery] with **[▲]/[▼]** or **[ENC]** control and press **[A/B]**.

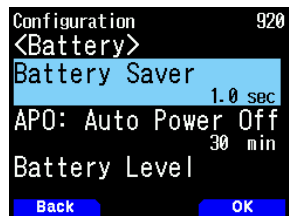

- 4 Select [Battery Saver] with **[▲]/[▼]** or **[ENC]** control and press **[A/B]**.

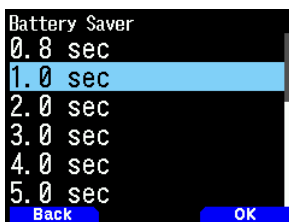

- 5 Select a setting value with **[▲]/[▼]** or **[ENC]** control and press **[A/B]** to set the value.

- 6 Press **[MENU]**.

The menu mode ends and the frequency screen appears. For subsequent menu operations, steps 1 to 4 will be referred to as "Access Menu No. XXX".

Note:

- ◆ Pressing **[PTT]** during each operation ends menu mode without confirming the setting.
- ◆ Pressing **[MODE]** during each operation returns to the previous screen. Also, pressing **[MODE]** during step 4 discards the new setting value and returns to the previous operation.
- ◆ Pressing **[MENU]** in scanning cancels scan.

Software Key operation

Software keys (**[Back]**, **[OK]**, etc.) are displayed in the key guide area of various setting screens and other screens. To select or operate the displayed functions, press the corresponding keys.

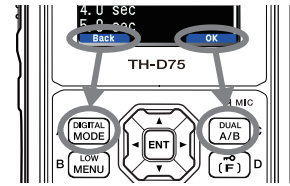

Example:

[Back] → Press **[MODE]**: Returns to the previous screen without confirming the displayed setting.

[OK] → Press **[A/B]**: Changes to the next screen.

CHARACTER ENTRY

In the screens that require you to enter text such as the screen for entering a memory name or power-on message, there are two methods to enter text. One is to enter text using the number keys in the same ways as a mobile phone and the other is to enter text by selecting characters one by one with the Multi-Scroll Key or **[ENC]** control.

Keypad Character Entry

- 1 Enter text with **[0]** to **[9]**, **[*]**, **#[#]**, and **[ENT]**.

- The each press of a key changes the character that can be entered.
- To enter another character assigned to the same key, move the cursor to the next position with **[▶]** (**[◀]** moves the cursor to the previous position) and enter the next character.
- Pressing **[A/B]** deletes a character. The character at the cursor position is deleted. The backspace operation is performed when there is a blank space.
- Pressing **[◀]/[▶]** moves the cursor.

Example: Entering the power-on message (Menu No.903)



- Pressing **[MODE]** input the space.
- Pressing **[A/B]** clears the text.

- 2 Press **[▶]**.

The cursor moves to the right.

- 3 Press **[ENT]**.

The text is confirmed and text input ends.

Entering Text with the Multi Scroll Key or [ENC]

- 1 Display the character with [▲]/[▼] or [ENC] control.
- 2 Press [▶].
The character or symbol is entered and the cursor moves to the right.
Pressing [A/B] deletes the character selected by the cursor. If it is pressed when there is no character selected by the cursor, the cursor moves to the left.

Auto Cursor Shift

This function provides assistance for entering text using the number keys. It is convenient to use this function when consecutively entering characters with the same key because it automatically moves the cursor to the right after a set time has passed.

You can set this time until the cursor is moved to the desired time.

- 1 Access Menu No. 945.
Select [Off], [1.0], [1.5], or [2.0] seconds.
- 2 Press [ENT].

MENU CONFIGURATION

No.	Display	Description	Setting Values
TX/RX - RX			
100	Programmable VFO	Programmable VFO setting (Band A only)	Varies with the selected frequency band
101	Beat Shift	Beat shift	Type 1 - Type 8
102	USB Out Select	USB output select	AF / IF/ Detect
103	FM Narrow	FM narrow	Off / On
104	MW/ SW Antenna	MW/ SW Antenna	ANT connector / Bar Antenna
105	WX Alert	Weather alert	Off / On (TH-D75A only)
TX/RX - TX			
110	TX Inhibit	TX inhibit	Off / On
111	Time-out Timer	Time-out timer	0.5/ 1.0/ 1.5/ 2.0/ 2.5/ 3.0/ 3.5/ 4.0/ 4.5/ 5.0/ 10.0 [min]
112	Mic. Sensitivity	Microphone sensitivity	High/ Medium / Low
TX/RX - RX Filter			
120	SSB High Cut	SSB high cut frequency	2.2/ 2.4 / 2.6/ 2.8/ 3.0 [kHz]
121	CW Width	CW bandwidth	0.3/ 0.5/ 1.0 / 1.5/ 2.0 [kHz]
122	AM High Cut	AM high cut frequency	3.0/ 4.5/ 6.0 / 7.5 [kHz]
TX/RX - Scan			
130	Resume	Resume method	Time / Carrier/ Seek
131	Resume (Digital)	Resume method (Digital)	Time/ Carrier/ Seek
132	Time Restart	Time operate restart time	1 - 5 - 10 [sec]
133	Carrier Restart	Carrier operate restart time	1 - 2 - 10 [sec]
134	Priority Scan	Priority scan	Off / On
135	Scan Auto Backlight	Scan auto backlight	Off / On
136	Auto Weather Scan	Auto Weather Channel Scan	Off / On (TH-D75A only)
TX/RX - Repeater			
140	Offset Frequency	Offset frequency	Varies with the selected frequency band
141	Auto Offset	Auto repeater offset	Off / On
142	CALL Key	CALL key function	CALL (TH-D75A)/ 1750Hz (TH-D75E)
143	1750Hz TX Hold	1750 Hz TX hold	Off / On
TX/RX - VOX			
150	VOX	VOX on/ off	Off / On
151	Gain	VOX gain level	0 - 4 - 9
152	Delay	VOX delay time	250/ 500 / 750/ 1000/ 1500/ 2000/ 3000 [ms]
153	TX on Busy	VOX on busy	Off / On
TX/RX - DTMF			
160	Encode Speed	Encode speed	50/ 100 / 150 [ms]
161	Pause Time	Pause time	100/ 250/ 500 / 750/ 1000/ 1500/ 2000 [ms]
162	TX Hold	TX hold	Off / On
163	DTMF Memory	DTMF memory	Up to 10 channels for DTMF memory channel Up to 16 characters for DTMF memory name Up to 16 digits for DTMF memory code
164	EchoLink Memory	EchoLink memory	Up to 10 channels for EchoLink memory channel Up to 8 characters for EchoLink memory name Up to 8 digits for one channel code

No.	Display	Description	Setting Values
TX/RX - CW			
170	Pitch Frequency	Pitch frequency	400 - 800 - 1000 [Hz]
171	Reverse	Reverse	Normal / Reverse
TX/RX - Others			
180	QSO Log	QSO log	Off / On
181	LED Control	LED control	RX : Check FM Radio: Uncheck
Memory - Memory Channel			
200	View List	Memory channel list	-
201	Group Name	Memory group name input	Up to 16 characters
202	Recall Method	Memory channel recall method	All Bands / Current Band
203	Group Link	Memory group link registration	register up to 30 memory group links
204	CALL Ch List	CALL channel list	-
Memory - Repeater List			
210	View List	Repeater list	-
Memory - Callsign List			
220	View List	Callsign list	-
Memory - Hotspot List			
230	View List	Hotspot list	-
Audio File - Recording File			
300	View List	Recording file list	-
301	Recording	Recording	Stop / Start
302	Recording Band	Recording band	A Band / B Band
Audio File - Voice Message			
310	View List	Voice message list	-
311	TX Monitor	TX monitor	Off / On
312	Digital Auto Reply	Digital auto reply	Off / Voice Message 1 - Voice Message 4
GPS - Basic Settings			
400	Built-in GPS	Built-in GPS	Off/ On
401	My Position	My position	GPS / My Position 1 - 5
402	Position Ambiguity	Position ambiguity mode	Off / 1-Digit - 4-Digit
403	Operating Mode	Built-in GPS operating mode	Normal / GPS Receiver
404	Battery Saver	Battery saver time	Off/ 1min/ 2min/ 4min/ 8min/ Auto
405	PC Output	GPS data output to PC	Off / On
406	Sentence	Sentence	\$GPGGA / \$GPGLL/ \$GPGSA / \$GPGSV/ \$GPRMC / \$GPVTG
GPS - Track Log			
410	Track Log	Track log recording	Off / On
411	Clear Track Log	Clear track log	-
412	Record Method	Record method	Time / Distance/ Beacon
413	Interval	Interval time	2 - 10 - 1800 [sec]
414	Distance	Distance	0.01 - 9.99 [mile, km, nm]
APRS - Basic Settings			
500	My Callsign	Callsign entry (for APRS)	Up to 9 characters
501	Icon	Icon	Person / Bicycle/ Motorcycle, etc. (total 68 icons)
502	Position Comment	Position comment	Off Duty/ Enroute/ In Service / Returning/ Committed/ Special/ PRIORITY/ CUSTOM0 ~ CUSTOM6/ EMERGENCY!
503	Status Text	Status text	Status Text: 1 - 5 TX Rate: Off/ 1/1 - 1/4 - 1/8 Up to 42 characters
504	Packet Path	Packet path type	Type: New-N / Relay/ Region/ Others1-Others3, WIDE1-1: Off/On, RELAY: Off/On, ABBR: Up to 5 characters, Total Hops: 0 - 1 - 7, Path: Up to 79 characters
505	Data Speed	Data communications speed	1200 bps / 9600 bps
506	Data Band	Internal data band type	A Band / B Band
507	DCD Sense	DCD sense type	Busy / Detect Data/ Off (Ignore)
508	TX Delay	TX delay time	100/ 150/ 200 / 300/ 400/ 500/ 750/ 1000 [ms]
509	APRS Lock	APRS lock	Frequency/ PTT/ APRS Key: All unchecked

No.	Display	Description	Setting Values
APRS - Beacon TX Control			
510	Method	Method	Manual/ PTT/ Auto / SmartBeaconing
511	Initial Interval	Initial Interval timer	0.2/ 0.5/ 1 / 2/ 3/ 5/ 10/ 20/ 30/ 60 [min]
512	Decay Algorithm	Decay Algorithm	Off/ On
513	Prop. Pathing	Prop. Pathing	Off/ On
514	Speed	Speed	Off/ On
515	Altitude	Altitude	Off / On
516	Object	Object name	Name: up to 9 characters, Type: Live Object / Killed Object/ Live Item/ Killed Item, Method: Off/ Temp. / Auto(15 min)/ Auto(30 min)/ Auto(60 min), N(S): Latitude, E(W): Longitude, Icon (Total 68 kinds): Eyeball / Portable (Tent)/ HAM store, etc., Comment: up to 42 characters
APRS - QSY Information			
520	QSY Info. in Status	QSY information in status	Off / On
521	Tone/Narrow	Tone/ Narrow	Off / On
522	Shift/Offset	Shift/ Offset	Off / On
523	QSY Limit Distance	QSY limit distance	Off / 10/ 20 ... 2490/ 2500 [mile, km, nm]
APRS - SmartBeaconing			
530	Low/High Speed	Low speed/ High speed setting	Low Speed: 2 - 5 - 30 [mile/h, km/h, knots] High Speed: 2 - 70 - 90 [mile/h, km/h, knots]
531	Slow Rate	Low speed transmission interval time	1 - 30 - 100 [min]
532	Fast Rate	High speed transmission interval time	10 - 120 - 180 [sec]
533	Turn Angle	Driving direction change, minimum value setting	5 deg - 28 deg - 90 deg
534	Turn Slope	Driving direction change, additional value setting	1 (10deg/speed) - (26 10deg/speed) - 255 (10deg/speed)
535	Turn Time	Minimum time delay between each beacon transmission	5 - 60 - 180 [sec]
APRS - Waypoint			
540	Format	Way point format	NMEA / MAGELLAN/ KENWOOD
541	Length	Way point name length	6-Char / 7-Char/ 8-Char/ 9-Char
542	Output	Way point output type	All / Local/ Filtered
APRS - Packet Filter			
550	Position Limit	Position limit	Off / 10/ 20 ... 2490/ 2500 [mile, km, nm]
551	Filter Type	Filter type	Weather/ Digipeater/ Mobile/ Object/ NAVITRA/ 1-WAY/ Others
APRS - Message			
560	User Phrases	User phrases	Up to 32 characters x 20 phrases
561	Auto Reply	Auto message reply	Off / On
562	Reply To	Reply to	Up to 9 characters
563	Reply Delay Time	Reply delay time	0/ 10 / 20/ 30/ 60 [sec]
564	Reply Message Text	Reply message text input	Up to 50 characters
APRS - Notification			
570	RX Beep	RX beep	Off/ Message Only/ Mine/ All New/ All
571	TX Beep	TX beep	Off/ On
572	Special Call	Special call	Up to 9 characters
573	Display Area	Display area	Entire Always / Entire Display/ One Line
574	Interrupt Time	Interrupt time	3/ 5/ 10 / 20/ 30/ 60/ infinite [sec]
575	APRS Voice	APRS voice	Off / On
APRS - Digipeat			
580	Digipeat(MyCall)	Digipeat function	Off / On
581	Uicheck	UI check time	1 - 28 - 250 [sec]
582	Uidigipeat	Uidigipeat	Off / On
583	Uldigi Aliases	Uldigi aliases	Up to 9 characters x 4
584	Ulflood	Ulflood	Off / On
585	Ulflood Alias	Ulflood alias	Up to 5 characters
586	UlfloodSubstitution	Ulflood substitution	First / ID/ NOID
587	Ultrace	Ultrace	Off / On
588	Ultrace Alias	Ultrace alias	Up to 5 characters

No.	Display	Description	Setting Values
APRS - Others			
590	PC Output	PC output type	Off / Raw Packets/ Waypoints
591	Network	Network type	APRS[APK005] / Altnet
592	Voice Alert	Voice alert type	Off / On/ RX Only
593	VA Frequency	VA frequency type	67.0 - 100.0 - 254.1 Hz
594	Message Group Code	Message group code	Up to 9 characters x 6 codes (ALL,QST,CQ,KWD)
595	Bulletin Group Code	Bulletin group code	Up to 5 characters x 6 codes
Digital - RX History			
600	View History	View History	-
Digital - TX/RX			
610	My Callsign	Callsign entry (for DV/DR mode)	Up to 8 characters + up to 4 characters
611	TX Message	TX message	Off / 1/ 2/ 3/ 4/ 5
612	Direct Reply	Direct reply	Off/ On
613	Auto Reply Timing	Auto reply timing	Immediate / 5/ 10/ 20/ 30/ 60 [sec]
614	Data TX End Timing	Data TX end timing	Off / 0.5/ 1/ 1.5/ 2 [sec]
615	EMR Volume Level	EMR Volume level	1 - 25 - 50
616	RX AFC	RX AFC	Off/ On
617	FM Auto Det. on DV	FM auto detector on DV	Off / On
618	Data Frame Output	Data Frame Output	All / Related to DSQ/ DATA Mode
619	Break Call	Break Call	Off / On
Digital - Digital Squelch			
620	Select Type	Select Type	Off /Code Squelch/ Callsign Squelch
621	Digital Code	Digital Code	00 - 99
Digital - GPS Data TX			
630	GPS Info. in Frame	GPS Information in frame	Off / On
631	Sentence	Sentence	\$GPGGA / \$GPGLL/ \$GPGSA/ \$GPGSV/ \$GPRMC / \$GPVTG/ APRS Sentence
632	Auto TX	Auto TX	Off / 0.2/ 0.5/ 1/ 2/ 3/ 5/ 10/ 20/ 30/ 60 [min]
Digital - RX Notification			
640	Display Method	Display method	Off/ All / Related to DQS/ My Station Only
641	Single Display Size	Single display size	Half Display/ Entire Display
642	Dual Display Size	Dual display size	Half Display/ Entire Display
643	Display Hold Time	Display hold time	0 / 3/ 5/ 10 / 20/ 30 / 60/ Infinite [sec]
644	Callsign Announce	Callsign announce	Off / Kerchunk/ Except Kerchunk/ My Station Only/ All
645	Standby Beep	Standby beep	Off / On
Digital - DV Gateway			
650	DV Gateway Mode	DV Gateway mode setting	Off / Reflector TERM Mode
651	My Callsign	Callsign entry (for DV Gateway mode)	Up to 8 character callsign + 6 patterns of up to 4 character identification code
652	RPT1	RPT1 (for DV Gateway mode)	Up to 8 characters
653	RPT2	RPT2 (for DV Gateway mode)	Up to 8 characters
654	Device Information	Device name	Up to 16 characters
FM Broadcasting - Basic Settings			
700	FM Radio Mode	FM radio mode	Off / On
701	Auto Mute RET. Time	Auto mute return time	1 - 3 - 10 [sec]
FM Broadcasting - Memory			
710	FM Radio List	FM radio list	-
SD Card - Export			
800	Config Data	Config data	-
801	Config Data + V.Msg	Config data and voice message	-
802	Repeater List Only	Repeater list only	-
803	Callsign List Only	Callsign list only	-
SD Card - Import			
810	Config Data	Config data	-
811	Config Data + V.Msg	Config data and voice message	-
812	Repeater List Only	Repeater list only	-
813	Callsign List Only	Callsign list only	-

No.	Display	Description	Setting Values
SD Card - Unmount			
820	Execute	Unmount execute	-
SD Card - Format			
830	Execute	Format execute	-
SD Card - Memory Size			
840	View	Free capacity	-
Configuration - Display			
900	Backlight Control	Backlight control	Auto/ Auto (DC-IN) / Manual/ On
901	Backlight Timer	Backlight timer	3 - 10 - 60 [sec]
902	LCD Brightness	LCD brightness	High / Medium/ Low
903	Power-on Message	Power-on message input	Up to 16 characters
904	Single Band Display	Single band display type	Off/ GPS(Altitude) / GPS(GS)/ Date / Demodulation Mode
905	Meter Type	Meter type	Type 1 / Type 2/ Type 3
906	Background Color	Background color select	Black / White
907	Info. Backlight	Information Backlight	Off/ LCD/ LCD+Key
Configuration - Audio			
910	Balance	Audio balance	A:100/ B:0, A:100/ B:25, A:100/ B:50, A:100/ B:75, A:100/ B:100 , A:75/ B:100, A:50/ B:100, A:25/ B:100, A:0/B:100, Operation Band Only
911	TX/RX EQ	TX/RX EQ	RX EQ/ TX EQ(FM, NFM)/ TX EQ(DV)
912	TX EQ Level	TX EQ Level	-9 - ±0 - +3 [dB]
913	RX EQ Level	RX EQ Level	-9 - ±0 - +9 [dB]
914	Beep	Beep	Off/ On
915	Beep Volume	Beep volume	Volume Link / Level 1 - Level 7
916	Voice Guidance	Voice guidance	Off / Manual/ Auto1/ Auto2
917	Voice Guidance Vol.	Voice guidance volume	Volume Link / Level 1 - Level 7
918	VoiceGuidanceSpeed	Voice guidance speed	Speed 1 - Speed 4
919	Callsign Readout	Callsign readout method	Standard / Full Phonetics/ Suffix Phonetics
91A	USB Audio Out. Lvl.	USB Audio Output level	Level 1 - Level 7
Configuration - Battery			
920	Battery Saver	Battery Saver	Off/ 0.2/ 0.4/ 0.6/ 0.8/ 1.0 / 2.0/ 3.0/ 4.0/ 5.0 [sec]
921	APO: Auto Power Off	APO: Auto Power Off	Off/ 15/ 30 / 60 [min]
922	Battery Level	Battery Level	-
923	Charging	Battery charging when power is on	Off / On
Configuration - Bluetooth			
930	Bluetooth	Bluetooth	Off / On
931	Connect	Connect	-
932	Device Search	Device Search	-
933	Disconnect	Disconnect	-
934	Pairing Mode	Pairing Mode	-
935	Device Information	Device Information	Up to 19 characters
936	Auto Connect	Auto Connect	Off / On
Configuration - Auxiliary			
940	PF1 Key	PF1 Key	Recording - Voice Message 1-4 - Voice Guidance - Battery Level - VOX - Group Name - Balance (PF1) - GPS (PF2) - Track LOG - SQL - SHIFT - STEP - LOW - Key Lock - Lockout - M>V - T. SEL - NEW - Voice Alert - LCD Brightness - DTMF CH0 - EchoLink CH0 - 1750Hz Tone - M. IN
941	PF2 Key	PF2 Key	Recording - Voice Message 1-4 - Voice Guidance - Battery Level - VOX - Group Name - Balance - GPS - Track LOG - SQL - SHIFT - STEP - LOW - Key Lock - Lockout - M>V - T. SEL - NEW - Voice Alert - LCD Brightness - DTMF CH0 - EchoLink CH0 - 1750Hz Tone - Screen Capture - MODE - MENU - A/B (PF1 Mic) - VFO (PF2 Mic) - MR (PF3 Mic) - CALL- MSG - LIST - BCON - REV - TONE - MHz - MARK - DUAL - APRS - OBJ - ATT - FINE - POS - BAND - MONI - UP - DOWN
942	PF1 (Mic)	PF1 (Mic)	Recording - Voice Message 1-4 - Voice Guidance - Battery Level - VOX - Group Name - Balance - GPS - Track LOG - SQL - SHIFT - STEP - LOW - Key Lock - Lockout - M>V - T. SEL - NEW - Voice Alert - LCD Brightness - DTMF CH0 - EchoLink CH0 - 1750Hz Tone - Screen Capture - MODE - MENU - A/B (PF1 Mic) - VFO (PF2 Mic) - MR (PF3 Mic) - CALL- MSG - LIST - BCON - REV - TONE - MHz - MARK - DUAL - APRS - OBJ - ATT - FINE - POS - BAND - MONI - UP - DOWN
943	PF2 (Mic)	PF2 (Mic)	Recording - Voice Message 1-4 - Voice Guidance - Battery Level - VOX - Group Name - Balance - GPS - Track LOG - SQL - SHIFT - STEP - LOW - Key Lock - Lockout - M>V - T. SEL - NEW - Voice Alert - LCD Brightness - DTMF CH0 - EchoLink CH0 - 1750Hz Tone - Screen Capture - MODE - MENU - A/B (PF1 Mic) - VFO (PF2 Mic) - MR (PF3 Mic) - CALL- MSG - LIST - BCON - REV - TONE - MHz - MARK - DUAL - APRS - OBJ - ATT - FINE - POS - BAND - MONI - UP - DOWN
944	PF3 (Mic)	PF3 (Mic)	Recording - Voice Message 1-4 - Voice Guidance - Battery Level - VOX - Group Name - Balance - GPS - Track LOG - SQL - SHIFT - STEP - LOW - Key Lock - Lockout - M>V - T. SEL - NEW - Voice Alert - LCD Brightness - DTMF CH0 - EchoLink CH0 - 1750Hz Tone - Screen Capture - MODE - MENU - A/B (PF1 Mic) - VFO (PF2 Mic) - MR (PF3 Mic) - CALL- MSG - LIST - BCON - REV - TONE - MHz - MARK - DUAL - APRS - OBJ - ATT - FINE - POS - BAND - MONI - UP - DOWN
945	Cursor Shift	Cursor shift	Off / 1.0/ 1.5/ 2.0 [sec]
946	Secret Access Code	Secret access code input	000 - 999 (TH-D75A only)

No.	Display	Description	Setting Values
Configuration - Date & Time			
950	Setting	Date and time setting	-
Configuration - Lock			
960	Keys Lock Type	Keys lock type	Key Lock/ Frequency Lock
961	DTMF Keys Lock	DTMF keys lock	Off/ On
962	Mic Keys Lock	Microphone keys lock	Off/ On
963	Volume Lock	Volume lock	Off/ On
Configuration - Units			
970	Speed, Distance	Speed/ Distance	mi/h, mile (TH-D75A)/ km/h, km (TH-D75E)/ knots, nm
971	Altitude, Rain	Altitude/ Rain	feet, inch (TH-D75A)/ m, mm (TH-D75E)
972	Temperature	Temperature	°F (TH-D75A)/ °C (TH-D75E)
973	Latitude, Longitude	Latitude/ Longitude	dd°mm.mm' / dd°mm'ss.s"
974	Grid Square Format	Grid square format	Maidenhead Grid/ SAR Grid (CONV)/ SAR Grid (CELL)
Configuration - Interface			
980	USB Function	USB Function	COM+AF/IF Output/ Mass Storage
981	PC Output (GPS)	PC Output (GPS)	USB/ Bluetooth
982	PC Output (APRS)	PC Output (APRS)	USB/ Bluetooth
983	KISS	PC Input/ Output (KISS)	USB/ Bluetooth
984	DV/DR	PC Input/ Output (DV/DR)	USB/ Bluetooth
985	DV Gateway	PC Input/ Output (DV Gateway)	USB/ Bluetooth
Configuration - System			
990	Language	Language	English/ Japanese
991	Version	Firmware version	-
999	Reset	Reset	VFO Reset/ Partial Reset/ Full Reset

Note:

- ◆ Menu descriptions and setting values are subject to change without prior notice.
- ◆ Bold character in setting values indicates a default setting.

7 OPERATING THROUGH FM REPEATERS

Repeaters are often installed and maintained by radio clubs, sometimes with the cooperation of local businesses involved in the communications industry.

Compared to simplex communication, you can usually transmit over much greater distances by using a repeater. Repeaters are typically located on mountain tops or other elevated locations. They generally operate at higher ERP (Effective Radiated Power) than a typical station. This combination of elevation and high ERP allows communications over considerable distances.

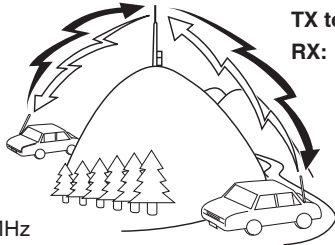

TX: 144.725 MHz
TX tone: 88.5 Hz
RX: 145.325 MHz

TX: 144.725 MHz
TX tone: 88.5 Hz
RX: 145.325 MHz

REPEATER ACCESS

Most repeaters use a receive and transmit frequency pair with a standard or non-standard offset (odd-split). In addition, some repeaters must receive a tone from the transceiver in order to gain access to the repeater. For details, consult your local repeater reference.

Selecting an Offset Frequency

The offset frequency is the value which the transmit frequency will be offset from the receive frequency. The default offset frequency on the 144 MHz band is 600 kHz for all type versions. The default on the 430/440 MHz band is 5 MHz.

- 1 Select your desired band A or B.
- 2 Access Menu No. 140.
 - The selectable range is from 00.00 MHz to 29.95 MHz, in steps of 50 kHz.

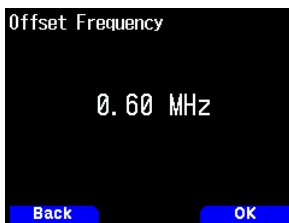

Note:

- ◆ After changing the offset frequency, the new offset frequency will also be used by Automatic Repeater Offset.

Automatic Repeater Offset

This function automatically selects an offset direction and activates the Tone function, according to the frequency that you have selected. To obtain an up-to-date band plan for repeater access, refer to the information from your national Amateur Radio association.

- 1 Access Menu No. 141.



- 2 Select [On] and exit the menu.
- 3 Press [A/B] to select the operating band.
- 4 Press [VFO] to select VFO mode.
- 5 Select your operating frequency.
- 6 Press [PTT] to start transmission.
 - You will be transmitting on an offset frequency value determined from your offset setting value and an offset direction depending on your selected frequency. Refer to the settings below for offset directions:

TH-D75A:

Under 145.100 MHz:	No offset (Simplex operation)
145.100 ~ 145.499 MHz:	- 600 kHz offset
145.500 ~ 145.599 MHz:	No offset (Simplex operation)
146.000 ~ 146.399 MHz:	+ 600 kHz offset
146.400 ~ 146.599 MHz:	No offset (Simplex operation)
146.600 ~ 146.999 MHz:	- 600 kHz offset
147.000 ~ 147.399 MHz:	+ 600 kHz offset
147.400 ~ 147.599 MHz:	No offset (Simplex operation)
147.600 ~ 147.999 MHz:	- 600 kHz offset
148.000 MHz and higher:	No offset (Simplex operation)
Under 223.920 MHz:	No offset (Simplex operation)
223.920 ~ 224.999 MHz:	- 1.6 MHz
225.000 MHz and higher:	No offset (Simplex operation)
Under 442.000 MHz:	No offset (Simplex operation)
442.000 ~ 444.999 MHz:	+ 5 MHz offset
445.000 ~ 446.999 MHz:	No offset (Simplex operation)
447.000 ~ 449.999 MHz:	- 5 MHz offset
450.000 MHz and higher:	No offset (Simplex operation)

TH-D75E:

Under 145.000 MHz:	No offset (Simplex operation)
145.600 ~ 145.799 MHz:	- 600 KHz offset
145.800 MHz and higher:	No offset (Simplex operation)

Activating the Tone Function

To turn the Tone function on:

- 1 Select your desired band A or B.
- 2 Press **[TONE]** to turn the Tone function On.
 - Each time you press **[TONE]**, the selection changes as follows:
Tone (**T**) → CTCSS (**CT**) → DCS (**DCS**) → Cross Tone (**D/O**: default) → Off (no display).
Additionally, when APRS is ON and Voice Alert is configured, Voice Alert ON is added to the above cycle.
 - The **< T >** icon appears on the display when the tone function is On.



Selecting a Tone Frequency

To select the tone frequency required to access your desired repeater:

- 1 Turn the Tone function On.
- 2 Press **[F]**, **[TONE]**.
 - The current Tone frequency appears on the display and blinks. The default frequency is 88.5 Hz.

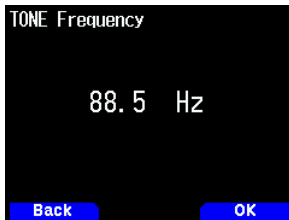

- 3 Select your desired frequency.
- 4 Press **[ENT]** to set the selected frequency.

Note:

- ◆ If you have set up a Memory channel with a tone setting, simply recall the Memory channel instead of setting up the tone frequency every time.

No.	Frequency (Hz)	No.	Frequency (Hz)	No.	Frequency (Hz)
01	67.0	18	118.8	35	183.5
02	69.3	19	123.0	36	186.2
03	71.9	20	127.3	37	189.9
04	74.4	21	131.8	38	192.8
05	77.0	22	136.5	39	196.6
06	79.7	23	141.3	40	199.5
07	82.5	24	146.2	41	203.5
08	85.4	25	151.4	42	206.5
09	88.5	26	156.7	43	210.7
10	91.5	27	159.8	44	218.1
11	94.8	28	162.2	45	225.7
12	97.4	29	165.5	46	229.1
13	100.0	30	167.9	47	233.6
14	103.5	31	171.3	48	241.8
15	107.2	32	173.8	49	250.3
16	110.9	33	177.3	50	254.1
17	114.8	34	179.9		

Tone Frequency ID

This function scans through all tone frequencies to identify the incoming tone frequency on a received signal. You can use this function to find which tone frequency is required by your local repeater.

- 1 Press **[TONE]** to turn the Tone function On.
 - The **< T >** icon appears on the display.
- 2 Press **[F]**, press and hold **[TONE]** to run the Tone Frequency ID scan.
 - Scan starts and "Scanning" blinks on the display.
 - To quit the scan, press **[◀]**.
 - When a Tone frequency is identified, the identified frequency appears on the display and blinks.

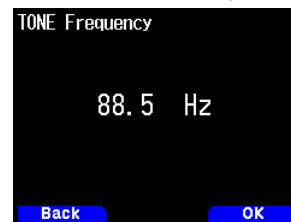

- 3 Press **[A/B]** to program the identified frequency in place of the currently set tone frequency.

TRANSMITTING A 1750 Hz TONE

Some of the few repeaters require that a transceiver transmit a 1750 Hz tone. On a TH-D75E, simply pressing [CALL] will transmit this tone. It is also possible to program [1750Hz] on the front panel as a [CALL] key for transmitting the 1750 Hz tone.

- 1 Access Menu No. 142.

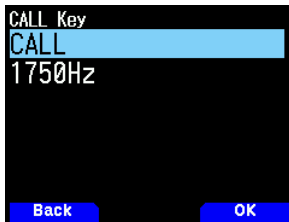

- 2 Set to [1750Hz].

This transceiver is also capable of remaining in the transmit mode for 2 seconds after transmitting a 1750 Hz tone.

- 1 Access Menu No. 143.

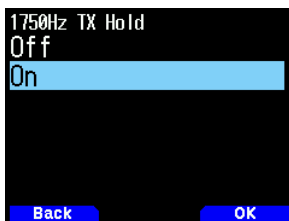

- 2 Set to [On].

Note:

- ◆ While remaining in the transmit mode, the transceiver does not continuously transmit a 1750 Hz tone.

Selecting an Offset Direction

The offset direction allows your transmit frequency to be higher (+) or lower (-) than the receive frequency.

- 1 Select your desired band (A or B).
- 2 Press [F], [REV] to select an offset direction.
 - Each time you press [F], [REV], the offset direction changes as follows:

Simplex operation → + → - → Simplex operation

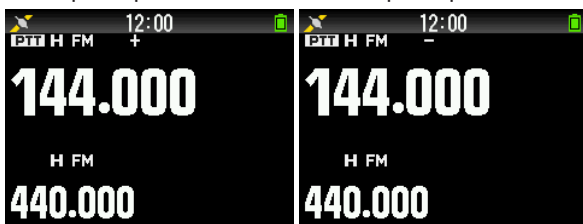

- If you are using a TH-D75E, when operating on the 430 MHz band, the offset direction changes as follows:
Simplex operation → + → - → (-7.6 MHz) → Simplex operation

If the offset transmit frequency falls outside the allowable range, transmitting is inhibited. Use one of the following methods to bring the transmit frequency within the band limits:

- Move the receive frequency further inside the band.
- Change the offset direction.

Note:

- ◆ While using an odd-split memory channel or transmitting, you cannot change the offset direction.

REVERSE FUNCTION

After setting a separate receive and transmit frequency, you can exchange these frequencies using the Reverse function. This allows you to manually check the strength of signals you receive directly from other stations, while using a repeater. If the station's signal is strong, move to a simplex frequency to continue the contact and free up the repeater.

- 1 Press [REV] to turn the Reverse function [On] or [Off].
 - When the Reverse function is On, the < R > icon will appear on the display.



Note:

- ◆ If the transmit frequency is outside the allowable transmit frequency range when using Reverse, pressing [PTT] will cause an error tone to sound and transmission will be inhibited.
- ◆ If the receive frequency is outside the receive frequency range when using Reverse, an error tone will sound and Reverse will not operate.
- ◆ The ARO (Automatic Repeater Offset) will not function when Reverse is ON.
- ◆ You cannot switch Reverse On or Off while transmitting.

8 MEMORY CHANNEL

In Memory channels, you can store frequencies and related data that you often use. Then you need not reprogram the data every time. You can quickly recall a programmed channel by simple operation. A total of 1101 Memory channels (1000 Memory channels, 100 Program scan memory channels, and a Priority scan memory channel) are available.

SIMPLEX & REPEATER OR ODD-SPLIT MEMORY CHANNEL?

You can use each memory channel as a simplex & repeater channel or as an odd-split channel. Store only one frequency to use as a simplex & repeater channel or two separate frequencies to use as an odd-split channel. Select either application for each channel depending on the operations you have in mind.

Simplex & repeater channels allow:

- Simplex frequency operation
- Repeater operation with a standard offset (if an offset direction is stored)

Odd-split channels allow:

- Repeater operation with a non-standard offset

The data listed below can be stored in each Memory channel:

Parameter	Simplex & Repeater	Odd-split
Receive frequency	Yes	Yes
Transmit frequency		Yes
Receive frequency step size	Yes	Yes
Transmit frequency step size		Yes
Offset direction	Yes	No
Tone On/Off	Yes	Yes
Tone frequency	Yes	Yes
CTCSS On/Off	Yes	Yes
CTCSS frequency	Yes	Yes
DCS On/Off	Yes	Yes
DCS code	Yes	Yes
Shift	Yes	No
Reverse On/Off	Yes	No
Memory channel lockout *2	Yes	Yes
Memory channel name	Yes	Yes
Demodulation mode	Yes	Yes
Cross tone	Yes	Yes
Fine mode	Yes	Yes
(Digital squelch) type *	Yes	No
(Digital squelch) digital code *	Yes	No
Destination Callsign *	Yes	No
Access repeater Callsign *	Yes	No
Destination repeater Callsign *	Yes	No

Note:

- ◆ Program scan memory and priority scan memory are excluded.
- ◆ *: Data for the digital mode (DV/DR)

MEMORY CHANNEL LIST

The memory channel configurations can be displayed on the Memory Channel List screen. In the Memory Channel List screen, you can select a channel to store or to recall. You can assign a name to a Memory Channel.

- 1 Press **[MR]** to switch to the memory mode.
- 2 Press **[ENT]**.

Memory channel list appears. You can also access to the memory channel list by Menu No. 200.

Channel	Frequency	Mode
0	144.000	FM
1		
2	145.170	FM
3	440.575	FM
4	446.100	DV
5		

Memory channel type

Display	Type
[0] to [999]	Memory channels
[L 0], [U 0] to [L49], [U49]	Program scan memory
[Pri]	Priority scan memory
[A 1] to [A10]	Weather channels (TH-D75A only)
[C]	CALL channels

- 3 Select the channel.

You can select the channel by inputting the channel number from 0 to 999 by 12 keypad. When you select 1 or 2 digits channel, you can also select by inputting the channel number and pressing **[ENT]**.

- 4 Press **[ENT]**.

The selected channel is set and return to the frequency display.

Switching Memory Name Display

The memory channel list display can be switched to frequency or memory name.

- 1 Press **[A/B]**.

Each press switches between frequency display and memory name display.

Channel	Frequency	Mode	Channel	Frequency	Mode
0	446.125	AM	0	JVC	
1			1		
2	145.170	FM	2	KENWOOD	
3	440.575	FM	3	JVCKENWOOD	
4	446.100	DV	4	446.100	DV
5	144.035	FM	5	144.035	FM

Storing Simplex and Standard Repeater Frequencies

- 1 Select the frequency, mode, etc.
- 2 Press [F], [MR].
Memory channel registration screen appears on the display.

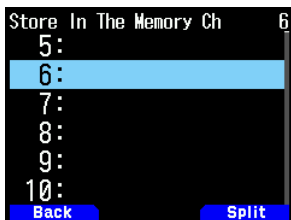

- 3 Select the memory channel number.
- 4 Press [ENT].
The simplex channel is registered.

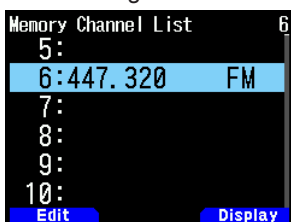

Storing Odd-Split Repeater Frequencies

When you change the RX and TX frequencies, register the RX frequency first and then register the TX frequency. Only the TX frequency cannot be registered.

- 1 Register the RX frequency.
A split channel can be registered only to an already registered memory channel.
- 2 Display the TX frequency.
- 3 Press [F], [MR].
Memory channel registration screen appears on the display.

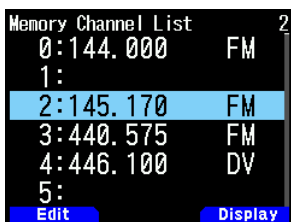

- 4 Select the memory channel number.
- 5 Press [A/B].
The split channel is registered.

Note:

- ◆ You cannot set the TX and RX frequencies on different frequency bands.

Clearing a Memory Channel

You can clear the specified channel of the registered memory channels.

- 1 Press [MR] to enter the memory mode.
- 2 Press [ENT].
The memory channel list appears. You can also access to the memory channel list by Menu No. 200.
- 3 Select the specified channel and press [MENU].
The memory channel list menu appears.
- 4 Select [Clear Memory] and press [A/B].
A confirmation message appears on the display.

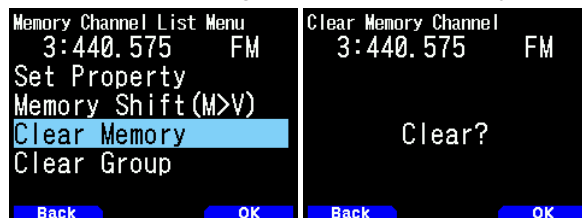

- Press [MODE] to return to the memory channel list menu.
- 5 Press [A/B].
The specified memory channel is cleared.
To clear another memory channel, repeat the procedure from step 3.

RECALLING A MEMORY CHANNEL

You can recall a memory channel in the order of the channel number or select from a memory channel list.

Recalling in the order of memory channel number

- 1 Press [MR] to enter Memory Recall mode.
- 2 Press [▲]/[▼] or rotate the [ENC] control to select your desired Memory channel.
 - Additionally, you can enter a channel number using the keypad.

Recalling from the memory channel list

- 1 Press [MR] to enter Memory Recall mode.
Memory channels in the current frequency band or all memory channels will be recalled according to the setting in menu No. 202.
- 2 Press [ENT].
The Memory channel list appears.
- 3 Press [▲]/[▼] or rotate the [ENC] control or enter a 3-digit channel number using the keypad.
The entered memory channel number will appear at the top of the list. When the memory channel number is two digits or less, press [ENT] after the number.
- 4 Press [ENT].
The selected channel is configured and the screen returns to the frequency display.

Note:

- ◆ When a split channel is recalled, "±" appears on the display.
- ◆ A memory channel number cannot be recalled by keypad input if the memory channel is registered as program scan memory.

Memory Recall Method

This menu provides you with the option to recall memory channels with stored frequencies in your current frequency band, or all memory channels:

- 1 Access Menu No. 202.

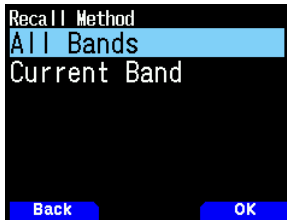

- 2 Select [All Bands] or [Current Band].

[All Bands]: This allows you to recall all programmed memory channels.

[Current Band]: This allows you to recall only those memory channels that have stored frequencies within the current frequency band.

Note:

- ◆ This setting also applies to the memory scan and group link scan.

EDITING MEMORY CHANNEL

Setting the group in each memory channel, you can set registration of memory name and the lock-out for the memory scan.

Setting Group

Each memory channel will be allocated to a group from group 0 to group 29. When a new memory channel is registered, it will be allocated to the group of the digit in the hundreds place. (CH.0 is group 0, CH.100 is group 1, CH.200 is group 2, etc.) If a group is configured, memory channels for each group will be recalled and memory channel scan can be enabled for each group.

- 1 Display a memory channel list.

Press [ENT] in memory mode or call up the memory channel list from Menu No. 200.

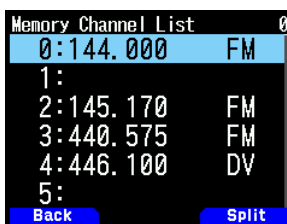

- 2 Select a channel and press [MODE].

The memory channel edit menu appears.



- 3 Select [Group] and press [A/B].

The memory group selection screen appears.



- 4 Select any group from group 0 (GRP-0) to group 29 (GRP-29) and press [A/B].

The selected group is set.

- 5 Press [MODE] or [MENU].

Press [MODE] to return to the memory channel list. If you wish to set up another memory channel group, repeat from step 2. Press [MENU] to return to the frequency display.

Registering a Memory Name

You can assign a memory name of up to 16 characters to a memory channel. This is convenient because you can search with a callsign or place name for example, using a repeater.

- 1 Display a memory channel list.

Press [ENT] in memory mode or call up the memory channel list from Menu No. 200.

- 2 Select a channel and press [MODE].

The memory channel edit menu appears.



- 3 Select [Name] and press [A/B].

The memory name edit screen appears.



- 4 Edit the name.

- 5 Press [ENT].

The edited memory name is registered.

- 6 Press [MODE] or [MENU].

Press [MODE] to return to the memory channel list. If you wish to register a memory name for another memory channel, repeat from step 2. Press [MENU] to return to the frequency display.

CALL CHANNEL MEMORY (SIMPLEX)

The CALL channel can be used to store any frequency and related data that you will recall often. You may want to dedicate the CALL channel as an emergency channel within your group.

- 1 Select the frequency, mode, etc.
- 2 Press **[F]**, **[CALL]**.

Note:

- ◆ Storing new data in the CALL channel will clear the old data. (The CALL channel itself cannot be cleared, but data can be replaced with new data.)

CALL CHANNEL MEMORY (ODD-SPLIT)

The CALL channel can be used to store any frequency and related data that you will recall often. You may want to dedicate the CALL channel as an emergency channel within your group.

- 1 Register the RX frequency.
A split channel can be registered only to an already registered memory channel.
- 2 Display the TX frequency.
- 4 Press **[F]**
- 5 Press **[CALL]** while pressing **[PTT]**.

Note:

- ◆ You cannot set the transmission and reception frequencies on different bands.
- ◆ You cannot set a different frequency step size for the transmission and reception frequencies.
- ◆ You cannot store the transmit offset status and Reverse status in an odd-split CALL channel.

CALL CHANNEL LIST

Select a CALL channel from the menu. The selected channel can also be edited.

- 1 Access Menu No. 204.
The CALL channel list appears.

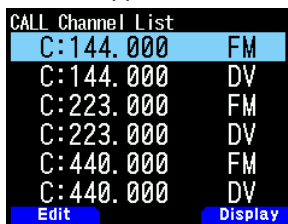

- 2 Select a CALL channel.
- 3 Press **[ENT]**.
The CALL channel is accessed.

Switching Memory Name Display

Each press **[A/B]** switches between frequency and memory name display.

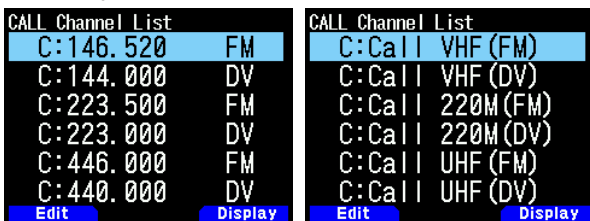

Editing a CALL Channel Name

You can name CALL channel using up to 8 characters.

- 1 Access Menu No. 204.
- 2 Select your desired CALL channel and press **[MODE]**.
The Property menu appears.

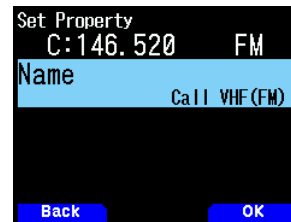

- 3 Edit the CALL channel name.



MEMORY GROUP

You can divide the 1000 memory channels into a group of 30, and control them.

Switching Memory Group

- 1 Press **[MR]** to enter Memory Recall mode.
- 2 Press and hold **[<|/|>]** to select your desired Memory group (**[>]**: increases Memory group number / **[<]**: decrease Memory group number). The group name is displayed for about 2 seconds in memory name display area.

Note:

- ◆ A Memory group in which memory channel has not been set is skipped.
- ◆ You can switch the memory group to All Groups or each 30 group.

Clearing on a Memory Group Basis

Clear memory channels you no longer use on a memory group basis.

- 1 Access Menu No. 200.
The memory channel list appears.
- 2 Press **[MENU]**.
The memory channel list menu appears.

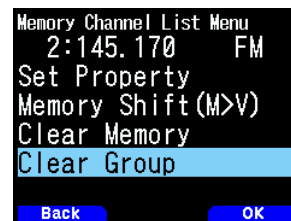

- Select [Clear Group] and press [A/B].
The clear group selection screen appears.

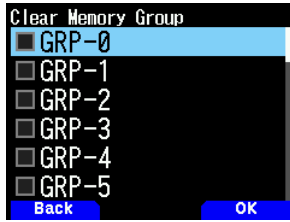

- Select the group to clear.
- Press [ENT].
Each press adds or removes a check mark.

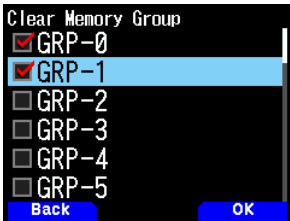

- Press [A/B].
The group clear confirmation screen appears.

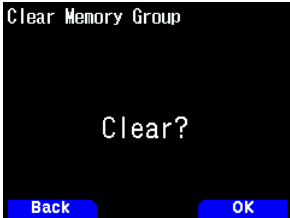

- To end the operation without clearing the group, press [MODE] to return to the previous screen.
- Press [A/B].
The specified group is cleared. If check marks are added to check boxes, multiple groups can be cleared simultaneously.

Memory Group Names

A name can be assigned to each of the 30 memory groups. You can assign a group name of up to 16 half-width characters (or 8 full-width characters).

- Access Menu No. 201.
The name edit group selection screen appears.



- Select a group and press [A/B].
The group name input screen appears.



- Edit the group name.
- Press [ENT].
The memory group name is registered and the frequency screen reappears.

MEMORY SHIFT

Shift the contents of a memory channel or CALL channel to VFO.

Shifting Memory from the Frequency Screen

- Press [MR] or [CALL] to enter Memory Recall mode or CALL channel mode.
- Recall your desired memory channel to shift to VFO. (This step is not necessary when selecting the CALL channel.)
- Press [F], [VFO].
The memory channel is copied to VFO.
 - The entire contents of the Memory channel or CALL channel are copied to the VFO, and VFO mode is selected after the transfer is complete.
 - When copying a transmit frequency from an odd-split Memory or CALL channel, you must first turn the Reverse function on before pressing [F], [VFO].

Shifting Memory from the Memory Channel List

- Press [MR] to enter Memory Recall mode.
- Press [ENT].
The memory channel list screen appears.
- Select the memory channel to shift to VFO.
- Press [MENU].
The memory channel list menu appears.



- Select [Memory Shift (M>V)] and press [A/B].
The memory channel is copied to VFO and switches to VFO mode.

Shifting Memory from the CALL channel List

- Access Menu No. 204.
- Select a CALL channel.
- Press [MENU].
The CALL channel list menu appears.



- Select [Memory Shift (M>V)].
- Press [A/B].
The memory channel is copied to VFO.

9 SCAN

Scan is a useful feature for hands-off monitoring of your favorite frequencies. Becoming comfortable with all types of Scan will increase your operating efficiency.

This transceiver provides the following types of scans.

Scan Type	Scan Range
Band Scan	Scans all frequencies on the current band.
Memory Scan	Scans all frequencies stored in the Memory channels.
Group Link Scan	Scans memory channel in the plural memory groups registered in the group link list..
Program Scan	Scans all frequencies within the programmed range, on the current band.
MHz Scan	Scans all frequencies within a 1 MHz range from the originating frequency.
Call Scan	Scans the Call channel as well as the currently selected VFO frequency or Memory channel.
Priority Scan	Priority Scan checks the Priority Channel every 3 seconds.

Note:

- ◆ Adjust the squelch level before using scan. Selecting a squelch level too low could cause scan to stop immediately.
- ◆ While using CTCSS or DCS, scan stops for any signal received; however, scan will immediately resume if the received signal does not contain the same CTCSS tone or DCS code that you selected.
- ◆ Pressing and holding [PTT] causes scan to temporarily stop if it is functioning on a non TX band.

SELECTING A SCAN RESUME METHOD

The transceiver stops scanning at a frequency or Memory channel on which a signal is detected. It then continues scanning according to which resume mode you have selected. You can choose one of the following modes.

Time-Operated mode

Scan will stop temporarily once the squelch opens. Scan will resume 5 seconds later (default setting) regardless of the squelch status.

Carrier-Operated mode

Scan will stop temporarily once the squelch opens. Scan will resume if the squelch remains closed for more than 2 seconds (default setting).

Seek mode

Scan will complete once the squelch opens, and it will not resume.

- 1 Access Menu No. 130.
 - In digital (DV/DR mode), access Menu No. 131.



- 2 Set the Scan Resume mode to [Time] (Time-Operated), [Carrier] (Carrier-Operated) or [Seek] (Seek).

Time-Operate Resume Time

Set the hold time for the Time-Operate scan method.

When a signal is received, scan will pause at that frequency for the duration of the hold time you set. When the set time elapses, scan will resume (even if the signal is still being received).

- 1 Access Menu No. 132.
- 2 Set the resume time to 1 ~ 10 sec.



Carrier-Operated Resume Time

Set the hold time for the Carrier-Operate scan method.

When a signal is received, scan will pause at that frequency. When the signal stops, scan will resume after the duration of the hold time you set.

- 1 Access Menu No. 133.



- 2 Set the resume time to 1 ~ 10 sec.

BAND SCAN

Band scan monitors all frequency range that is stored in Menu No. 100 (Programmable VFO), using the current frequency step size.

- 1 Select your desired operation band and frequency.
- 2 Press and hold [VFO].

Band scan appears and scan starts at the current frequency.

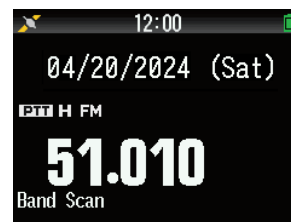

- The 1 MHz decimal point blinks while scanning is in progress.

Note:

- ◆ When starting a scan within the frequency range of the registered program scan memory, it is the program scan.
- ◆ During DR mode, press and hold [VFO], the DR scan menu screen will appear on the display. (refer to page No.16-14)

- 3 To quit band scan, press [VFO].

PROGRAM SCAN

Program scan is to scan within the range between the lower limit frequency and upper limit frequency registered to program scan memory. There are 50 program scan memory from L0/U0 to L49/U49.

Setting Scan Limits

- 1 Select the frequency, mode, etc. to register.
- 2 Press **[VFO]**.
- 3 Press **[F]**, **[MR]**.
Memory channel registration screen appears on the display.
- 4 To set a lower limit frequency, select channel [L0]. To set an upper limit frequency, select channel [U0].

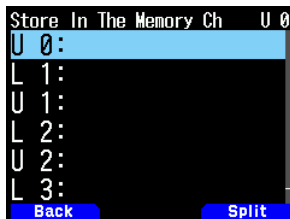

- 5 Press **[ENT]**.
The frequency is registered in the memory channel.
The picture below shows an example when a lower limit frequency is set in L0.



- 6 Register the corresponding upper limit or lower limit frequency.
Repeat steps 3 to 6. Memory channels from L1/U1 to L49/U49 can be registered similarly.

Using Program Scan

- 1 Adjust the frequency within the range of the program scan memory.
 - When the VFO frequency is within the registered frequency range in the program scan memory, [Program No. 0] appears under the frequency display.
- 2 Press and hold **[VFO]**.
The program scan starts and the dot of the 1 MHz digit flashes.
- 3 To quit program scan, press **[VFO]**.

Note:

- ◆ When a frequency range registered in the program scan memory is duplicated, the range assigned to a smaller program scan memory number will be applied.
- ◆ Band scan is activated if **[VFO]** is pressed for more than 1 second outside the program scan memory frequency range.

MHz SCAN

MHz scan monitors a 1 MHz segment of the band, using the current frequency step size. The current 1 MHz digit determines the limits of the scan. For example, if the current frequency is 145.400 MHz, then the scan range would be from 145.000 MHz to 145.995 MHz (the exact upper limit depends on the current frequency step size).

- 1 Select your desired band.
- 2 Press **[VFO]**.
- 3 Press **[▲]**/**[▼]** or rotate the **[ENC]** control to select a frequency within your desired 1 MHz range.
- 4 Press and hold **[MHz]** to start scanning.
 - Scan starts at the current frequency.
 - The 1 MHz decimal point blinks while scanning is in progress.
 - To reverse the scan direction, turn the **[ENC]** control clockwise <or press **[▲]**> (upward scan) or counterclockwise <or press **[▼]**> (downward scan).
- 5 To quit MHz Scan, press **[MHz]**.

MEMORY SCAN

Use memory scan to monitor all Memory channels programmed with frequency data.

- 1 Press and hold **[MR]**.
Scan starts at the current memory channel.

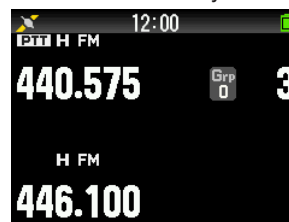

- 2 To quit memory scan, press **[MR]**.

Note:

- ◆ At least 2 Memory channels must contain data and must not be locked out of scan.
- ◆ Program scan memory and priority channel will be excluded from the memory scan.
- ◆ If the memory recall method is set to [Current Band], the memory channel of the same frequency band as the current memory channel will be scanned. The other memory channel will be skipped.

Locking Out a Memory Channel

This function allows you to skip specific memory channel by excluding it from scanning when a memory scan is performed.

- 1 Access Menu No. 200.

The memory channel list appears.

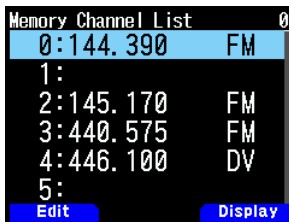

- 2 Select the channel to lock out.
- 3 Press [MODE].

The memory channel edit menu appears.



- 4 Select [Lockout] and press [A/B].

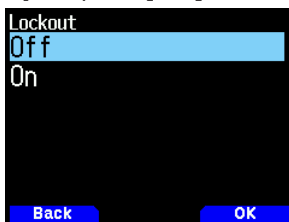

- 5 Select [On] and press [A/B].

Memory channel lockout is set.

If a memory channel for which the memory channel lockout function is set to [On] is recalled, < L > appears on the right of the channel number.

Note:

- ◆ This function can be set individually for all of the memory channels. However, it cannot be set for program scan memory (L0/U0 to L49/U49).
- ◆ The memory channel lockout function cannot be turned on or off in VFO mode or CALL channel mode.

GROUP LINK SCAN

Group link scan is to scan memory channel in the plural memory groups registered in the group link list.

Registering the Group Link List

Register the group link list to be used in the group link scan. You can link the maximum 30 memory groups randomly.

- 1 Access Menu No. 203.

The group link list appears.

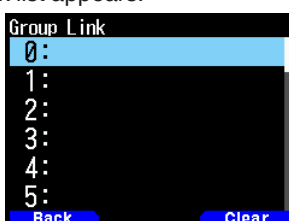

- 2 Select a group link number.

When a memory group is already linked, press [A/B] to cancel the link.

- 3 Press [ENT].

The Memory group selection screen appears.



- 4 Select the group to link and press [A/B].
 - 5 Set groups by repeating the procedure from step 2 to 4.
 - 6 Press [PTT].
- The frequency screen reappears.

Using Group Link Scan

This function allows you to scan memory channel in the plural memory groups registered in the group link list.

- 1 Register the group link list in advance.
- 2 Press [MR].
- 3 Press and hold [MHz].
 - Scan starts at the current channel.
 - The 1 MHz decimal point blinks while scanning is in progress.
- 4 To quit group link scan, press [MHz].

Note:

- ◆ At least 2 Memory channels in the selected group must contain data and must not be locked out of scan.
- ◆ When memory groups are not registered in the group link list, memory scan is executed.
- ◆ If the memory recall method is set to [Current Band], the memory channel of the same frequency band as the current memory channel will be scanned. The other memory channel will be skipped

PRIORITY SCAN

This function checks the frequency registered to the priority channel once every three seconds, and displays the priority channel to perform communication at that frequency if it is busy. When the frequency becomes no longer busy, the transceiver will return to the previous frequency and resume the priority scan if the state of no key being operated continues for 3 seconds.

Note:

- ◆ A frequency must be registered in advance in the priority channel [Pri].

- 1 Access Menu No. 134.

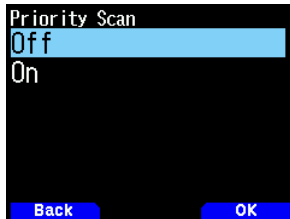

- 2 Select [On] or [Off].

[Off]: Turns off the priority scan function.

[On]: Turns on the priority scan function.

Note:

- ◆ When the Priority Scan function is set to ON, < P > will light up.
- ◆ When the priority channel becomes busy, the transceiver switches to the frequency display of the priority channel. Communication with the other station is possible in this state.
- ◆ If the state of no key being operated continues for 3 seconds when there is no signal, scanning starts again.
- ◆ Register an available RX frequency in the band B in the priority channel.
- ◆ This function can not be set to ON in selecting the Single band A.
- ◆ This function can not be set to ON when FM radio mode is On.

CALL SCAN

Use Call Scan to monitor both the Call channel and either the currently selected VFO frequency or the currently selected Memory channel.

- 1 Select your desired VFO frequency or Memory channel.
- 2 Press and hold [CALL] to start Call Scan.
 - The 1 MHz decimal point blinks while scanning is in progress.
 - When scanning with a Memory channel, the Call channel on the same band as the selected Memory channel is used for scan.
- 3 To quit Call Scan, press [CALL].

Note:

- ◆ The Memory channel selected is scanned even if it has been locked out of scan.

SCAN AUTO BACKLIGHT

This function turns on the backlight for approximately 2 seconds when scanning is paused. This function works with all scans.

- 1 Access Menu No. 135.

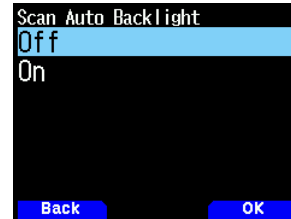

- 2 Select [On] or [Off].

[Off]: Turns off the scan auto backlight function.

[On]: Turns on the scan auto backlight function.

Note:

- ◆ This function does not work when [Backlight Control] (Menu No.900) is [Manual].
- ◆ The lighting duration of scan auto backlight cannot be changed.

10 CTCSS/DCS/CROSS TONE

CTCSS

You may sometimes want to hear calls only from specific persons. The Continuous Tone Coded Squelch System (CTCSS) allows you to ignore (not hear) unwanted calls from other persons who are using the same frequency. To do so, select the same CTCSS tone as selected by the other persons in your group. A CTCSS tone is subaudible and is selectable from among 50 tone frequencies.

DCS

Digital Coded Squelch (DCS) is another application which allows you to ignore (not hear) unwanted calls. It functions the same way as CTCSS. The only differences are the encode/decode method and the number of selectable codes. For DCS, you can select from 104 different codes.

Note:

- ◆ CTCSS/DCS does not cause your conversation to be private. It only relieves you from listening to unwanted conversations.

No.	Frequency (Hz)	No.	Frequency (Hz)	No.	Frequency (Hz)
01	67.0	18	118.8	35	183.5
02	69.3	19	123.0	36	186.2
03	71.9	20	127.3	37	189.9
04	74.4	21	131.8	38	192.8
05	77.0	22	136.5	39	196.6
06	79.7	23	141.3	40	199.5
07	82.5	24	146.2	41	203.5
08	85.4	25	151.4	42	206.5
09	88.5	26	156.7	43	210.7
10	91.5	27	159.8	44	218.1
11	94.8	28	162.2	45	225.7
12	97.4	29	165.5	46	229.1
13	100.0	30	167.9	47	233.6
14	103.5	31	171.3	48	241.8
15	107.2	32	173.8	49	250.3
16	110.9	33	177.3	50	254.1
17	114.8	34	179.9		

Note:

- ◆ CTCSS function, Tone function, and DCS function can not be set to On at the same time.
- ◆ CTCSS can be set separately in VFO mode, Memory Channel mode, and Call mode.
- ◆ When CTCSS function is changed to On or Off in Memory Channel mode or Call mode, it is a temporary change.

CTCSS

Using CTCSS

- Select your desired band.
- Press **[TONE]** 2 times to activate the CTCSS function.
 - The **< CT >** icon appears on the display when the CTCSS function is On.
 - Each time you press **[TONE]**, the selection changes as follows:
 Tone (**T**) → CTCSS (**CT**) → DCS (**DCS**) → Cross Tone (**D/O**: default) → Off (no display).
 Additionally, when APRS is ON and Voice Alert is configured, Voice Alert ON is added to the above cycle.



- Press **[F]**, **[TONE]**.
 - The current CTCSS frequency appears on the display and blinks. The default frequency is 88.5 Hz.

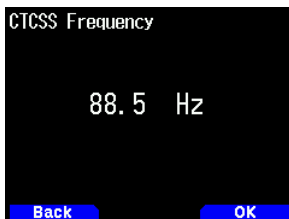

- Select your desired CTCSS frequency.
 - Refer to the table below for the available frequencies.
- Press **[A/B]** to complete the setting.
- When you are called:** The transceiver squelch opens only when the selected CTCSS tone is received.
When you make a call: Press and hold **[PTT]**, then speak into the microphone.
 - To cancel CTCSS, press **[TONE]** until **< CT >** no longer appears on the display.

CTCSS Frequency Scan

This function scans through all CTCSS frequencies to identify the incoming CTCSS frequency on a received signal. You may find this useful when you cannot recall the CTCSS frequency that the other persons in your group are using.

- Press **[TONE]** 2 times to activate the CTCSS function.
 - The **<CT>** icon appears on the display when the CTCSS function is On.
 - Each time you press **[TONE]**, the selection changes as follows:
Tone (**T**) → CTCSS (**CT**) → DCS (**DCS**) → Cross Tone (**D/O**: default) → Off (no display).
Additionally, when APRS is ON and Voice Alert is configured, Voice Alert ON is added to the above cycle.
- Press **[F]**, press and hold **[TONE]**.
 - Scan starts and "Scanning" blinks on the display.
 - To quit the scan, press **[◀]**.
 - When a CTCSS frequency is identified, the identified frequency appears on the display and blinks.

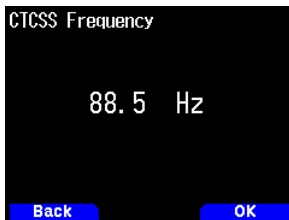

- Press **[A/B]** to program the identified frequency in place of the currently set CTCSS frequency.
 - The CTCSS function will remain On. To cancel CTCSS, press **[TONE]** until CT no longer appears on the display.

DCS

Using DCS

- Select your desired band.
- Press **[TONE]** 3 times to activate the DCS function.
 - The **<DCS>** icon appears on the display when the DCS function is on.
 - Each time you press **[TONE]**, the selection changes as follows:
Tone (**T**) → CTCSS (**CT**) → DCS (**DCS**) → Cross Tone (**D/O**: default) → Off (no display).
Additionally, when APRS is ON and Voice Alert is configured, Voice Alert ON is added to the above cycle.



- Press **[F]**, **[TONE]**.
 - The current DCS code appears on the display and blinks.

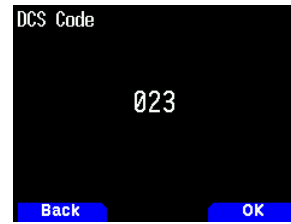

- Select your desired DCS code.
 - Refer to the table below for the available codes.
- Press **[A/B]** to complete the setting.
- When you are called:** The transceiver squelch opens only when the selected DCS code is received.
When you make a call: Press and hold **[PTT]**, then speak into the microphone.
 - To cancel DCS, press **[TONE]** until DCS no longer appears on the display.

DCS Code							
023	025	026	031	032	036	043	047
051	053	054	065	071	072	073	074
114	115	116	122	125	131	132	134
143	145	152	155	156	162	165	172
174	205	212	223	225	226	243	244
245	246	251	252	255	261	263	265
266	271	274	306	311	315	325	331
332	343	346	351	356	364	365	371
411	412	413	423	431	432	445	446
452	454	455	462	464	465	466	503
506	516	523	526	532	546	565	606
612	624	627	631	632	654	662	664
703	712	723	731	732	734	743	754

DCS Code Scan

This function scans through all DCS codes to identify the incoming DCS code on a received signal. You may find it useful when you cannot recall the DCS code that the other persons in your group are using.

- Press **[TONE]** 3 times to activate the DCS function.
 - The **<DCS>** icon appears on the display when the DCS function is on.
 - Each time you press **[TONE]**, the selection changes as follows:
Tone (**T**) → CTCSS (**CT**) → DCS (**DCS**) → Cross Tone (**D/O**: default) → Off (no display).
Additionally, when APRS is ON and Voice Alert is configured, Voice Alert ON is added to the above cycle.

- 2 Press **[F]**, press and hold **[TONE]**.
 - Scan starts and “Scanning” blinks on the display.
 - To quit the scan, press **[◀]**.
 - When a DCS code is identified, the identified code appears on the display and blinks.



- 3 Press **[A/B]** to program the identified code in place of the currently set DCS code.
 - The DCS function will remain on. To cancel DCS, press **[TONE]** until DCS no longer appears on the display.

CROSS TONE

Using Cross Tone

You can set separate signaling types by TX and RX for when you access a repeater that uses different Encode/ decode signaling.

To turn the Cross Tone function On:

- 1 Press **[TONE]** 4 times to activate the Cross Tone function.
 - The **<D/O>** (default) icon appears on the display when the Cross Tone function is On.
 - Each time you press **[TONE]**, the selection changes as follows:
 Tone (**T**) → CTCSS (**CT**) → DCS (**DCS**) → Cross Tone (**D/O**: default) → Off (no display).
- Additionally, when APRS is ON and Voice Alert is configured, Voice Alert ON is added to the above cycle.

Selecting a Cross Tone mode

To select the cross tone/code frequency required to access your desired repeater:

- 1 Turn the Cross Tone function On.
- 2 Press **[F]**, **[TONE]**.
 - The Cross Tone setting appears on the display.

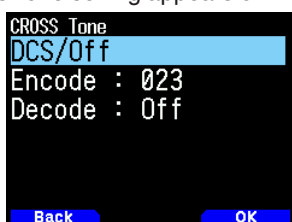

- 3 Select your desired Cross Tone setting.

Setting	Encode	Decode	Icon
DCS/Off	DCS	off	D/O
TONE/DCS	Tone	DCS	T/D
DCS/CTCSS	DCS	CTCSS	D/C
TONE/CTCSS	Tone	CTCSS	T/C

- 4 Press **[A/B]** to set the selected setting.

11 DUAL TONE MULTI-FREQUENCY(DTMF)

The keys on the keypad function as DTMF keys; the 12 keys found on a push-button telephone plus 4 additional keys (A, B, C, D). This transceiver provides 10 dedicated memory channels. You can store a DTMF code with up to 16 digits. Some repeaters in the U.S.A. and Canada offer a service called Autopatch. You can access the public telephone network via such a repeater by sending DTMF tones. For further information, consult your local repeater reference.

MANUAL DIALING

Manual Dialing requires only two steps to send DTMF tones.

- 1 Press and hold **[PTT]**.
- 2 Press the keys in sequence on the keypad to send DTMF tones.
 - The corresponding DTMF tones are transmitted.
 - If the DTMF Hold function is activated, you do not need hold down **[PTT]** while pressing keys. After transmitting the first tone (by pressing **[PTT]** and the first key), pressing additional keys will keep the transceiver in transmit mode for 2 seconds.

Selecting a Transmit Speed

Some repeaters may not respond correctly if a DTMF code is transmitted at fast speed. If this happens, change the DTMF code transmission speed.

- 1 Access Menu No. 160.

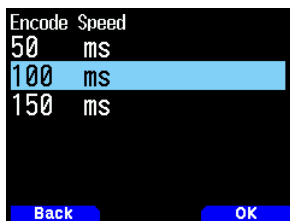

- 2 Select **[50]**, **[100]**, or **[150]** msec.

Selecting a Pause Duration

You can change the pause duration stored in DTMF Memory channels.

- 1 Access Menu No. 161.



- 2 Select **[100]**, **[250]**, **[500]**, **[750]**, **[1000]**, **[1500]**, or **[2000]** msec.

DTMF Hold

Activate this function to remain in transmit mode, after beginning to press keys when making a call.

- 1 Access Menu No. 162.



- 2 Set DTMF Hold to **[On]** to continue transmitting when pressing keys.
 - Set this menu to **[Off]** to stop the 2 second continuous transmission.

AUTOMATIC DIALER

There are 10 dedicated DTMF Memory channels available to store DTMF codes. You can store up to 16 digits in each channel.

Storing a DTMF Code in Memory

- 1 Access Menu No. 163.

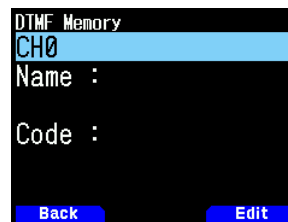

- 2 Select a channel number, then press **[ENT]**.
The name entry display appears.



- 3 Enter a name for the channel, then press **[ENT]** to set it.



- 4 Press **[ENT]**.
The code entry display appears.

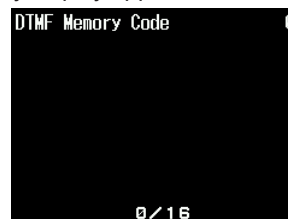

- 5 Enter a DTMF code for the channel.

When a space is entered, it becomes a "Pause" code.



- 6 Press [ENT].

DTMF memory channel is stored.



- If you want to store another DTMF memory channel, repeat the procedure from step 2.

Transmitting Stored DTMF Codes

- 1 Press and hold [PTT].
- 2 While transmitting, press [ENT].
 - The last called DTMF Memory channel number and name appears on the display. If no name has been saved for the channel, the DTMF code appears.



- 3 While still transmitting, press [▲]/[▼] or rotate the [ENC] control to select your desired DTMF Memory channel, then press [ENT] to transmit DTMF code.
 - Additionally, you can press a DTMF key corresponding to your desired channel ([0] ~ [9]) to select the channel and begin transmission.
 - The stored DTMF code scrolls across the display and is transmitted.
 - The code will be transmitted even if you release [PTT] before the entire code has scrolled across the display.
 - If no DTMF code is stored in the selected channel, the frequency display is restored.

DTMF Key Lock

This function will lock the DTMF transmission keys so that they will not transmit if they are accidentally pressed while transmitting. To lock the DTMF keys, turn this function On.

- 1 Access Menu No. 961.

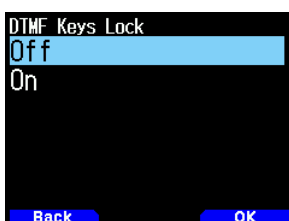

- 2 Set the key lock to [On] or [Off].

EchoLink MEMORY

EchoLink allows you to communicate with other amateur radio stations over the Internet, using VoIP (voice-over-IP) technology. The EchoLink software program allows worldwide connections to be made between stations, or from computer to station, greatly enhancing your communications capabilities.

Official EchoLink Website: <http://www.echolink.org>

Note:

- ◆ EchoLink memory channels do not store operating frequencies, tones, or power information.

Storing EchoLink Memory

There are 10 dedicated EchoLink DTMF memory channels available apart from the normal DTMF memory channels. You can register Callsigns, node numbers, and control commands. [Connect by call] and [Query by call] used in EchoLink are also available through simple operations by using the Callsign/DTMF auto conversion function.

Note:

- ◆ EchoLink is a registered trademark of Synergenics, LLC.

- 1 Access Menu No. 164.
- 2 Select EchoLink memory channel from 0 ~ 9.

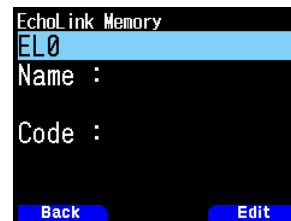

- 3 Press [A/B].
 - The name entry display appears.

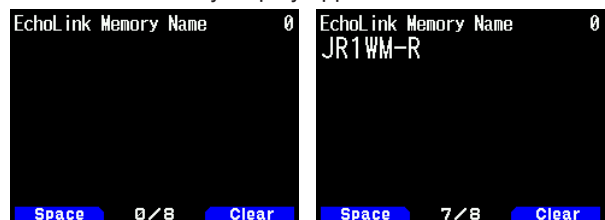

- 4 Enter the name for the channel.
 - The Callsign and conference name (for board rooms that can do round QSO) of the other station which is connected via EchoLink, or the control command name, etc., are entered into the EchoLink memory name.
- 5 Press [ENT].
 - The code entry display appears.

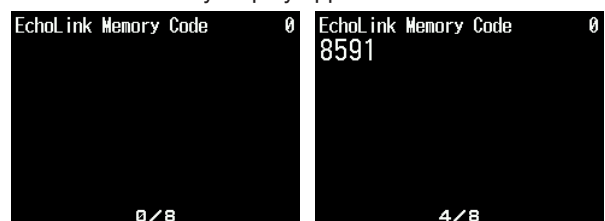

- 6 Enter a DTMF code for the channel.
 - The node number of the other station and conference which are connected via EchoLink, or the DTMF code of the control command, etc., are entered into the EchoLink code.
- 7 Press [ENT].
EchoLink memory code is stored.
 - If you want to store another EchoLink memory channel, repeat the procedure from step 2.

Transmitting EchoLink Memory

- 1 Press and hold [PTT].
- 2 While transmitting, press [ENT].
 - The last called EchoLink DTMF Memory channel name and number appears on the display.
- 3 While still transmitting, select EchoLink Memory channel.



- 4 While transmitting, press [ENT].
 - The stored code scrolls across the display and is transmitted.

Note:

- ◆ In step 2, press [C] key before pressing [ENT], to transmit the converted DTMF code of the EchoLink “Connect by Call” function. (example: JA1YKX)
“C” “51 21 10 93 52 92 #” (# is automatically added to the end of the DTMF code)
- ◆ In step 2, press [0] [7] keys before pressing [ENT], to transmit the converted DTMF code of the EchoLink “Query by Call” function. (example: JA1YKX)
“0” “7” “51 21 10 93 52 92 #” (# is automatically added to the end of the DTMF code)
- ◆ When only the EchoLink memory name has been registered, the EchoLink “Connect Call” function transmits the converted DTMF code. (example: JA1YKX)
“C 51 21 10 93 52 92 #” (C is automatically added to the beginning of the DTMF code and # is automatically added to the end)

Callsign/ DTMF Code Conversion Table

When a character other than an alphanumeric character is used (such as “-” and “/”), the DTMF conversion stops at the character before that non-standard character.

	1	2	3	4	5	6	7	8	9	0
0	1	2	3	4	5	6	7	8	9	0
1	Q	A	D	G	J	M	P	T	W	
2	Z	B	E	H	K	N	R	U	X	
3		C	F	I	L	O	S	V	Y	

12 OTHER OPERATIONS

FREQUENCY STEP SIZE

Choosing the correct frequency step size is essential in selecting your exact frequency. The default step size on the 144 MHz band is 5 kHz (TH-D75A) or 12.5 kHz (TH-D75E). The default on the 220 MHz band is 20 kHz (TH-D75A). The default on the 430 MHz band is 25 kHz.

- 1 Press **[VFO]** to enter VFO mode.
- 2 Press **[A/B]** to select band A or B.
- 3 Press **[F]**, **[PF2]**.

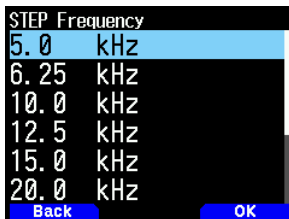

- 4 Select the **[▲]/[▼]** or **[ENC]** control your desired step size to [5.0], [6.25], [8.33], [9.0], [10.0], [12.5], [15.0], [20.0], [25.0], [30.0], [50.0], or [100.0] kHz.
- 5 Press **[A/B]** to store the new setting.

Note:

- ◆ Each band can have a separate selectable step frequency.
- ◆ The step size can be set in VFO mode only.
- ◆ The step size can not be set in FM broadcasting
- ◆ 8.33 kHz can be selected in 118 MHz band only.
- ◆ 9.0 kHz can be selected in LF/MF(AMBC) only.
- ◆ Changing between step sizes may correct the displayed frequency. For example, if 144.995 MHz is displayed with a 5 kHz step size selected, changing to a 12.5 kHz step size corrects the displayed frequency to 144.9875 MHz.

FINE TUNING

When you operate the Band B in LSB, USB, CW, or AM mode, you can turn the Fine Tuning function ON.

You can further configure the Fine Tuning frequency step size from 20 Hz, 100 Hz, 500 Hz, or 1000 Hz.

To activate the Fine Tuning function:

- 1 Press **[VFO]** to enter VFO mode.
- 2 Select the Band B.
 - The operating mode must be LSB, USB, CW or AM.
- 3 Press **[F]**, **[MHz]**, then set [On].

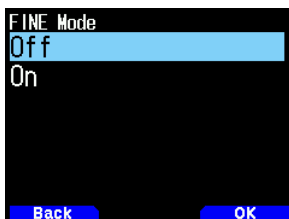

- 4 Change the frequency using **[▲]/[▼]** or rotate the **[ENC]** control.



- 100 Hz digit appears.
- 5 Press **[F]**, **[MHz]**, then set [Off] to exit Fine Tuning mode.

Note:

- ◆ You cannot activate the Fine Tuning function on the A-band.
- ◆ The Fine Tuning function does not work in DV and FM mode (FM/ WFM/NFM).
- ◆ While in Fine Tuning mode, you cannot change the frequency step size, MHz mode, and MHz Scan.
- ◆ Simply turning the Fine Tuning function OFF will not change the current frequency or display. However, when you change the frequency, the transceiver will use the currently selected frequency step size and adjust the frequency accordingly, removing the transceiver from a finely tuned frequency.

Fine Tuning Frequency Step

You can select Fine Tuning frequency step.

To select the Fine Tuning frequency step size:

- 1 Select a frequency on the B-band.
- 2 While the Fine Tuning mode is activated, press **[F]**, **[PF2]**.
 - The current frequency step size appears.

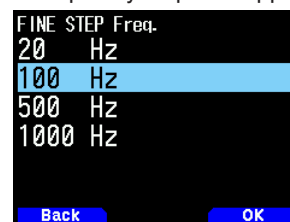

- 3 Select your desired frequency step to [20], [100], [500], or [1000] Hz.
- 4 Press **[A/B]** to store the new setting.

Note:

- ◆ Fine Tuning frequency step can be set separately for each frequency band.

ATTENUATOR (ATT)

When, for example, the target signal is difficult to hear because the other station is too strong or strong signals exist nearby, it may become easier to hear if you turn on the attenuator.

- 1 Press **[F]**, **[PF1]**.

Each press turns the function on or off.



- When the attenuator is on, **< ATT >** is displayed in the display area at the side of the operation band on the display.

Note:

- ◆ **< ATT >** is not displayed during scanning.
- ◆ It does not active on FM radio broadcast band.

PROGRAMMABLE VFO

If you always check frequencies within a certain range, you can set upper and lower limits for frequencies that are selectable. For example, if you select 144 MHz for the lower limit and 145 MHz for the upper limit, the tunable range will be from 144.000 MHz to 145.995 MHz.

- 1 Select the Band A.
- 2 Select your desired VFO frequency.
- 3 Access Menu No. 100.

The lower frequency limit blinks.



- 4 Select with [▲]/[▼] or [ENC] control your desired lower frequency limit, and press [ENT].

The upper frequency limit blinks.



- 5 Select with [▲]/[▼] or [ENC] control your desired upper frequency limit.



- 6 Press [A/B] to set the selected value.

Note:

- ◆ You cannot program the 100 kHz and subsequent digits. The exact 100 kHz and subsequent digits of the upper limit depend on the frequency step size you are using.
- ◆ The upper limit frequency cannot be set lower than the selected lower limit frequency.

BEAT SHIFT

Since the transceiver uses a microprocessor to control various transceiver functions, the CPU clock oscillator's harmonics or image may appear on some spots of the reception frequencies. Select a Beat Shift setting from Type 1 ~ Type 8, which does not cause interference.

- 1 Access Menu No. 101

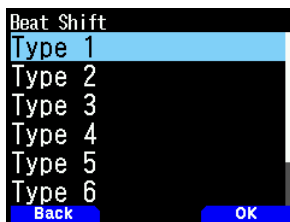

- 2 Select among from [Type 1] to [Type 8].

AF/ IF/ DETECT OUTPUT MODE

Selecting [AF], [IF], or [Detect] also outputs IF and detection signals from the speakers.

Connecting diagrams with the PC

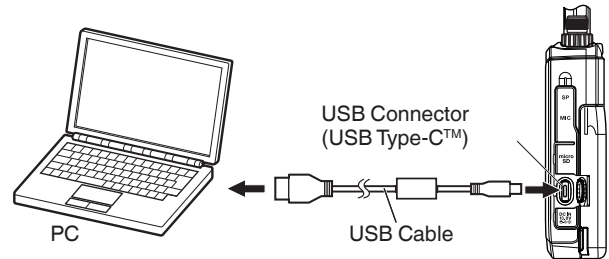

- 1 Press [A/B] to select a band B.
- 2 Press [F], [A/B] to select the Single band.
- 3 Access Menu No. 102.

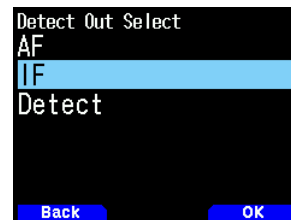

- 4 Select [AF], [IF], or [Detect].

AF output mode [AF]:

The received sound is output.

IF output mode [IF]:

The received IF signal of the band B is output to the PC.

- Change the frequency with [▲]/[▼] or [ENC] control.
- Change the band with [◀]/[▶].

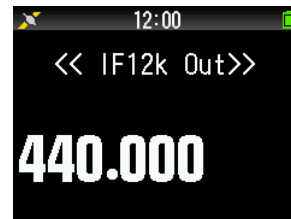

Detect output mode [Detect]

The decoded signal of the band B is output to the PC.

- Change the frequency with [▲]/[▼] or [ENC] control.
- Change the band with [◀]/[▶].
- Change the modulation/demodulation mode with [MODE].



Note:

- ◆ When other than [Off(AF)] is selected, the A band is hidden and the received audio output of the A band stops.
- ◆ When KISS mode is on, [IF] or [Detect] cannot be selected in the menu.
- ◆ If the B band is not the operation target, [IF] or [Detect] cannot be selected in the menu.
- ◆ When DV mode is selected, [Detect] cannot be selected in the menu.
- ◆ For IF12kHz output, you can select the modulation/demodulation mode from AM/LSB/USB/CW.

- ◆ The recording function does not work the other than AF output mode. When the mode is switched to either [IF] or [Detect] in the menu during recording, recording ends.
- ◆ When the mode is switched to either [IF] or [Detect], the IF or detection signal is output from the internal speaker.
- ◆ When the mode is switched to either [IF] or [Detect], beeps and voice guidance sound are not output.
- ◆ Special PC software is required to process IF signal or detection signal. JVCKENWOOD does not provide any support regarding the procedure to connect to a PC or the PC software.

FM NARROW

The FM mode band can be switched between normal and narrow.

- 1 Press **[MODE]** to set FM mode.
- 2 Access Menu No. 103.

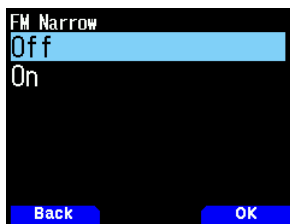

- 2 Select [On].
[Off]: Switches to normal FM mode.
[On]: Switches to narrow FM mode.

Note

- ◆ When FM Narrow is on, the mode always becomes NFM if FM is selected when switching the demodulation mode.
- ◆ Set this for each of the 144 MHz band and 430 MHz band and the HF band of the B band.

BAR ANTENNA

The transceiver uses a built-in bar antenna when receiving frequencies from 0.1 to 29.7 MHz. This function allows you to use the external antenna connector instead of the built-in bar antenna.

- 1 Access Menu No. 104.

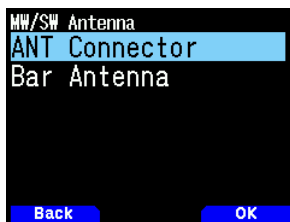

- 2 Select [On] or [Off].
[ANT Connector]: Uses the external antenna connector.
[Bar Antenna]: Uses the built-in bar antenna.

Note

- ◆ The bar antenna is directional (has a sensitivity direction). Sensitivity becomes better in the front-back direction of the transceiver so orient the transceiver to match the direction from which the radio waves come.
- ◆ When receiving with the bar antenna, stable reception may not be possible depending on the conditions, such as the location, building structure, window glass, roofing material, season, time, and ionospheric radio wave propagation, or fading may occur, making the received sound difficult to hear.
- ◆ The bar antenna is a simple antenna mainly on 0.1 to 10MHz range for the purpose of receiving strong signals such as signals from high-power broadcasting stations or signals that are nearby. When, for example, receiving a signal from a station that is far away or a low-power signal, we recommend using a dedicated external antenna tuned to the frequency of the target signal whenever possible.

TX INHIBIT

You can inhibit the transmission to prevent unauthorized individuals from transmitting, or to eliminate accidental transmissions while carrying the transceiver.

- 1 Access Menu No. 110



- 2 Select [On] or [Off].

[Off]: Disables the TX inhibit.

[On]: Enables the TX inhibit.

- [TX Inhibit] appears and an error beep sounds if the transceiver tries to transmit while TX Inhibit is [On].

TIME-OUT TIMER

The Time-out Timer limits the duration you transmit. Just before the transceiver stops the transmitting, a warning beep sounds. This function is necessary to protect the transceiver from thermal damage and can therefore not be turned OFF.

- 1 Access Menu No. 111.



- 2 Select [0.5], [1.0], [1.5], [2.0], [2.5], [3.0], [3.5], [4.0], [4.5], [5.0], or [10.0] minutes.

MICROPHONE SENSITIVITY

Change the microphone input sensitivity. The microphone input sensitivity setting applies to both the internal microphone and an external microphone.

- 1 Access Menu No. 112.

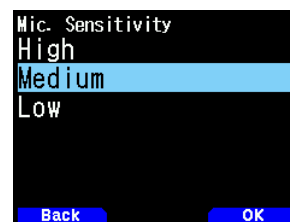

- 2 Select [Low], [Medium], or [High].

SETTING RECEIVING FILTERS

Reduce interference and noise in SSB mode, CW mode, and AM mode to make the received sound easier to hear.

SSB High Cut

- 1 Press **[MODE]** to set SSB mode in band B.
- 2 Access Menu No. 120.

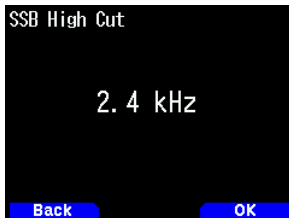

- 3 Select [2.2], [2.4], [2.6], [2.8], or [3.0] kHz ranges. Low cut is fixed to 200 Hz.

CW Bandwidth

- 1 Press **[MODE]** to set CW mode in band B.
- 2 Access Menu No. 121.

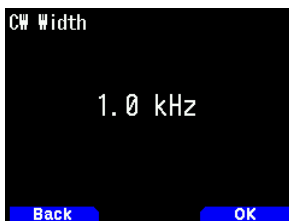

- 3 Select [0.3], [0.5], [1.0], [1.5], or [2.0] kHz ranges. The center of the filter is the pitch frequency.

AM High Cut

- 1 Press **[MODE]** to set AM mode in band B.
- 2 Access Menu No. 122.

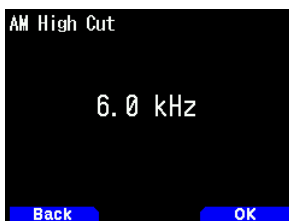

- 3 Select [3], [4.5], [6.0], or [7.5] kHz ranges. Low cut is fixed to 200 Hz.

VOX (VOICE-OPERATED TRANSMISSION)

VOX eliminates the necessity of manually switching to Transmit mode each time you want to transmit.

The transceiver automatically switches to Transmit mode when the VOX circuitry senses that you have begun speaking into the microphone.

When you operate the VOX function, you must use an optional Headset; the internal speaker and microphone are too close to each other to be used for the VOX function.

VOX On/ Off

- 1 Access Menu No. 150.



- 2 Select [On].
 - When VOX is activated, the gain level, and delay time will appear on the display.



Note:

- ◆ While in Menu mode, the VOX function is temporarily disabled.
- ◆ Since the VOX circuit must detect the presence of your voice, you may notice a slight delay in transmission; the very first part of your message may not be transmitted.
- ◆ When the VOX function is ON, the ASC function turns OFF.
- ◆ VOX cannot be used with an optional Speaker/ Microphone.

VOX Gain

To enjoy the VOX function, take the time to properly adjust the VOX Gain level. This level controls the VOX circuit to detect the presence or absence of your voice.

There are 2 ways to adjust the VOX Gain.

While the VOX function is ON:

- 1 Speak into the headset microphone using your normal tone of voice to transmit.



- 2 Adjust the VOX Gain by pressing **[▲]**/**[▼]** until the transceiver reliably switches to transmission mode each time you speak while the transceiver is transmitting.

Gain:9 (Transmit even in a small voice)



Gain:0 (Do not transmit)

From the Menu:

- 1 Access Menu No. 151.

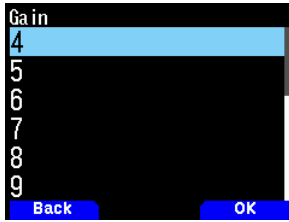

- 2 Select the desired VOX gain level.

VOX Delay Time

If the transceiver returns to reception mode too quickly after you stop speaking, the end of your transmission may not be sent. To avoid this, select an appropriate delay time that allows your entire transmission to be sent, before Transmit mode ends. However, do not make the delay overly long.

There are 2 ways to adjust the VOX Delay Time.

While the VOX function is ON:

- 1 Press [◀/▶] to change the delay time to 250, 500, 750, 1000, 1500, 2000, or 3000 ms.



From the Menu:

- 1 Access Menu No. 152.

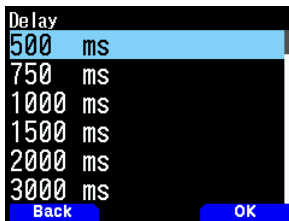

- 2 Select [250], [500], [750], [1000], [1500], [2000], or [3000] ms.

Note:

- ◆ If you press [PTT] while the VOX function is ON, the VOX Delay Time is not reflected to the transmission.
- ◆ If you press [CALL] (if 1750 Hz is programmed) to transmit a 1750 Hz tone, the VOX Delay Time is not reflected.
- ◆ If the DCS function is ON, the transceiver remains in Transmit mode for the duration set by the VOX Delay Time. It then sends a Turn-Off Code to close the receiving party's squelch.

VOX on Busy

You can configure the transceiver to force VOX transmission even if the transceiver is receiving a signal.

- 1 Access Menu No. 153.

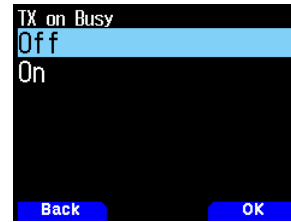

- 2 Select [On] or [Off].

[Off]: Do not operate VOX when the operation band is busy.

[On]: Operate VOX when the operation band is busy.

Note:

- ◆ You can press [PTT] or [CALL] (if 1750 Hz is programmed) to transmit, regardless of the setting in Menu No. 153.

PITCH FREQUENCY

This function set the pitch frequency during CW reception.

- 1 Access Menu No. 170.



- 2 Select among from [400] to [1000] Hz.

CW REVERSE

You can select the USB side [Normal] or LSB side [Reverse].

- 1 Press [MODE] to set CW mode.
- 2 Access Menu No. 171.



- 3 Select [Reverse] or [Normal].

LED CONTROL

This function turns off the BUSY LED to reduce the consumption of battery power. With the default setting, the BUSY LED is always on when receiving FM radio broadcasts.

- 1 Access Menu No. 181.
- 2 Press [ENT].

Each press change the check mark.

RX

(Check): The LED is on when receiving in bands A and B (including when receiving an FM radio broadcast in B-band).

(Uncheck): The LED is not on when receiving in normal operation mode (including when receiving an FM radio broadcast in B-band).

FM Radio

(Check): The LED is on when receiving an FM radio broadcast in FM radio mode.

(Uncheck): The LED is not on when receiving an FM radio broadcast in FM radio mode.



- 3 Press [A/B].
The change of a check mark is confirmed.

DISPLAY ILLUMINATION

The display and key illumination can be turned on when, for example, you use the transceiver in a dark location.

Temporary lighting

Press [⏻] to illuminate the display and keys.

- If no other key is pressed, the light turns OFF approximately 10 seconds (default) after releasing [⏻].
- Press any key (including [PTT]) other than [⏻] while the display and keys are lit to restart the 10-second timer (default).
- You can set the Display lighting time in Menu No. 901.
- Press [⏻] while the display and keys are lit to immediately turn the light OFF.

Lighting Method

The brightness of the LCD backlight can be set to any of three levels.

- 1 Access Menu No. 900.

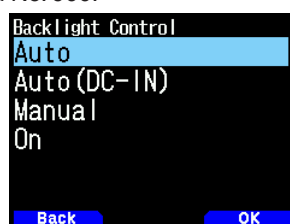

- 2 Select [Auto], [Auto (DC-IN)], [Manual], or [On].

[Auto]: The backlight turns on when operating any key or when rotating the [ENC] control. The backlight will turn off according to the Illumination Timer setting, or when the

[⏻] key is pressed.

- The backlight turns on when receiving the APRS interrupt signal.
- The backlight turns on when the scan is paused or stopped.

[Auto (DC-IN)]: When the battery is used, the operation is same as [Auto]. When DC-IN is used, the operation is same as [On].

[Manual]: The backlight turns on and off when the [⏻] key is pressed.

[On]: The backlight is always on while the power is on.

Lighting Timer

Set the lighting timer.

- 1 Access Menu No. 901.



- 2 Select among from [3] to [60] seconds.

Brightness

The brightness of the backlight can be set to any of three levels.

- 1 Access Menu No. 902.

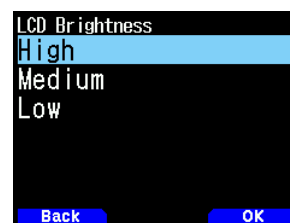

- 2 Select [High], [Medium], or [Low].

POWER ON MESSAGE

Each time you switch the transceiver on, [HELLO !!] (default) appears on the display for approximately 2 seconds. You can program your favorite message up to 16 characters instead of the default message.

- 1 Access Menu 903.



- 2 Enter your desired message.
 - Press [A/B] to clear the entire message, if necessary.
- 3 Press [ENT].

Note:

- ◆ Using the MCP-D75 software, you can change Bitmap of the Power ON graphic.

SINGLE BAND DISPLAY

You can change the displayed information during single band display.

Selecting the Information to Display

- 1 Access Menu No. 904

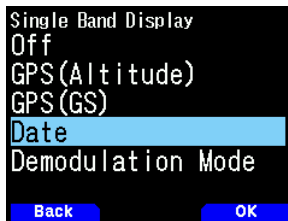

- 2 Select [Off], [GPS(Altitude)], [GPS(GS)], [Data], or [Demodulation Mode].

[Off]: The area around the band is blank.

[GPS(Altitude)]: The displayed information is as follows.

- Compass: Displays the direction to the target point (your direction if the target point is off).
- Your latitude and longitude are displayed.
- alt: Displays your altitude. (The unit varies depending on the Menu settings.)
- Relevant information is displayed until the target point is reached. (This is not displayed when the target point is off.)
- Target point name
- Angle
- Distance to the target point. (The unit varies depending on the MENU settings.)



[GPS(GS)]: The displayed information is as follows.

- Compass: Displays the direction to the target point (your direction if the target point is off).
- Your latitude and longitude are displayed.
- GS: Displays your grid square locator.
- Relevant information is displayed until the target point is reached.
- Target point name
- Angle
- Displays your movement speed. (The unit varies depending on the MENU settings.)

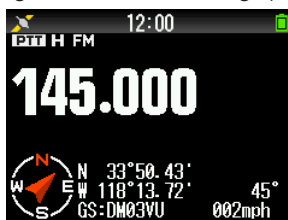

[Date]: Displays the date.



[Demodulation Mode]: Displays the demodulation mode.

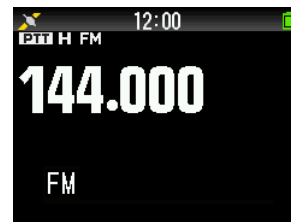

Note:

- ◆ When selecting [GPS(Altitude)] or [GPS(GS)], set the built-in GPS to [ON].

METER TYPE

This function changes the design of the S/RF meter.

- 1 Access Menu No. 905.

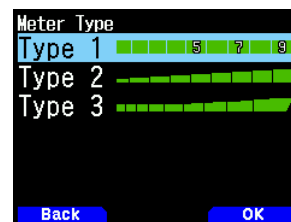

- 2 Select [Type 1], [Type 2], or [Type 3].

DISPLAY BACKGROUND COLOR

You can set the background color to black or white.

- 1 Access Menu No. 906.



- 2 Select [Black] or [White].

INFORMATION BACKLIGHT

Sets whether or not to turn on the backlight when APRS, D-STAR signal-receiving interrupt is displayed and when the scanning is paused or stopped.

- 1 Access Menu No. 907.

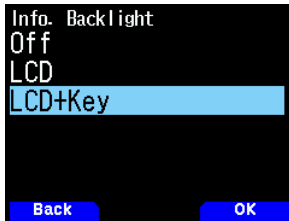

- 2 Select [Off], [LCD], or [LCD+Key].

[Off]:

Notify backlight does not light.

[LCD]:

Only LCD area is backlit when notified.

[LCD+Key]:

The backlight of LCD and Key areas is turned on when notification is made.

AUDIO EQUALIZER (TX/RX)

This function turns on or off the equalizer setting for transmission and receiving.

- 1 Access Menu No. 911.

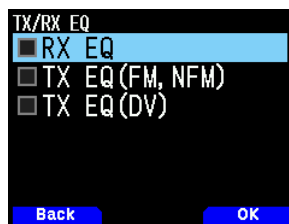

- 2 Select an item and press [ENT].

- 3 Press [A/B].

Check to turn on the equalizer function. Uncheck to turn off the function.

RX EQ: Receiving Equalizer

Turns On/Off the equalizer function of the received voice.

TX EQ (FM, NFM): Transmission Equalizer (Analog Voice)

Turns On/Off the equalizer function of the analog transmitted voice.

TX EQ (DV): Transmission Equalizer (Digital Voice)

Turns On/Off the equalizer function of the digital transmitted voice.

TX Equalizer

This function changes the transmission voice frequency characteristic. The frequency characteristic of the voice to be transmitted can be set to the below levels for each of four frequency band.

Frequency band (kHz)	Variable range (dB)
0.4	-9 - 0 - +3
0.8	-9 - 0 - +3
1.6	-9 - 0 - +3
3.2	-9 - 0 - +3

- 1 Access Menu No. 912.
- 2 Select a frequency band, then press [A/B].



- 3 Select a level, then press [A/B].



- 4 Press [MENU].

RX Equalizer

Change the received voice frequency characteristic. The frequency characteristic of the received voice can be set to the below levels for each of five frequency points.

Frequency band [kHz]	Variable range [dB]
0.4	-9 - 0 - +9
0.8	-9 - 0 - +9
1.6	-9 - 0 - +9
3.2	-9 - 0 - +9
6.4	-9 - 0 - +9

- 1 Access Menu No. 913.
- 2 Select a frequency point, then press [A/B].



- 3 Select a level, then press [A/B].



- 4 Press [MENU].

Note:

- ◆ The upper limit of the digital audio bandwidth is 4 kHz. For this reason, if the demodulation mode is DV/DR mode, the setting of 6.4 kHz are not reflected in the received voice.

KEY BEEP

You can set the transceiver beep function to [Off] or [On].

- 1 Access Menu No. 914.

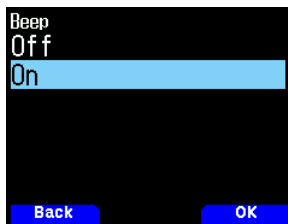

- 2 Select [On] or [Off].

Note:

- ◆ Even with the beep function turned off, the transceiver will beep 1 minute before the power turns off when Auto Power off is activated.
- ◆ After transmitting for the maximum time duration according to the Time-out Timer, the transceiver will beep.

BEEP VOLUME

You can set the beep volume.

The volume level can be changed by VOL Link (Linked with [VOL] control.), and set by a value among "Level 1" to "Level 7". A larger value results in a greater volume.

- 1 Access Menu No. 915.



- 2 Select [VOL Link] or [Level 1] - [Level 7].

BATTERY SAVER

The Battery Saver extends the operating time of the transceiver. It automatically activates when the squelch is closed and no key is pressed for more than 5 seconds. To reduce battery consumption, this function shuts the receiver circuit OFF for the programmed time, then momentarily turn it back ON to detect a signal.

To program the receiver shut-off period for the battery saver:

- 1 Access Menu No. 920.

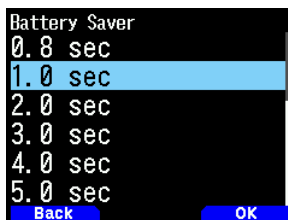

- 2 Select [0.2], [0.4], [0.6], [0.8], [1.0], [2.0], [3.0], [4.0], [5.0] seconds, or [Off].

AUTO POWER OFF (APO)

Automatic Power off is a background function that monitors whether or not any operations have been performed (keys pressed, [ENC] control turned, etc.), and turns the transceiver power off if it has not been in use.

To program the receiver shut-off period for the battery saver:

- 1 Access Menu No. 921.

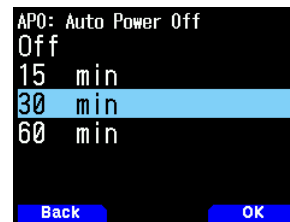

- 2 Set the APO time limit to [15], [30], [60] minutes, or [Off].
 - After the time limit passes with no operations (default is [Off]), APO turns the transceiver power off. However, 1 minute before the power turns off, [APO] appears on the display and blinks, and a warning tone sounds.

Note:

- ◆ A warning tone sounds when a Key Beep is set to Off.
- ◆ Automatic Power Off does not operate in scanning.

BATTERY LEVEL

You can verify the battery capacity while in Menu mode.

- 1 Access Menu No. 922.



Note:

- ◆ You can check the remaining battery level by voice guidance. Refer to page No.23-1 "SETTING VOICE GUIDANCE MODE".

CHARGING

You can set whether to charge the battery pack when a DC IN cable or USB cable is connected while the power is ON.

- 1 Access Menu No. 923.

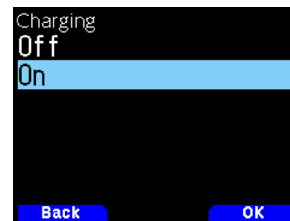

- 2 Select [On] or [Off].
 - [Off]:**
Does not charge when the power is ON.
 - [On]:**
Charges even when the power is ON.

Note:

- ◆ When the power is off, the battery will be charged regardless of the settings.

PROGRAMMABLE FUNCTION KEYS

Transceiver PF Keys and Microphone PF keys

Function name	Description
Recording	Recording start/ stop
Voice Message 1	Playback send voice messages 1
Voice Message 2	Playback send voice messages 2
Voice Message 3	Playback send voice messages 3
Voice Message 4	Playback send voice messages 4
Voice Guidance	Voice guidance
Battery Level	Battery Level
VOX	VOX ON/ OFF
Group Name	Setting the Memory group name
Balance	Setting the Volume balance
GPS	GPS ON/ OFF
Track LOG	Track LOG ON/OFF
SQL	Setting the Squelch
SHIFT	Switching the Shift direction
STEP	Setting the step frequency
LOW	Switching the RF power
Key Lock	Key Lock ON/OFF
Lockout	Channel Lockout ON/ OFF
M>V	Memory to VFO
T.SEL	Setting the Signaling
NEW	APRS new message
Voice Alert	Setting the Voice Alert
LCD Brightness	Brightness adjustment
DTMF CH0	Sending DTMF CH0
ECHOLINK CH0	Sending EchoLink CH0
1750Hz Tone	Sending 1750Hz tone

Transceiver PF keys only

Function name	Description
M.IN	Registration memory mode

Microphone PF keys only

Function name	Description
Screen Capture	Screen capture
MODE	Switching the Mode
MENU	Access Menu
A/B	Setting the Band A/ B
VFO	VFO mode
MR	Memory channel mode
CALL	CALL channel
MSG	Message list
LIST	Station list
BCON	Beacon
REV	Reverse
TONE	Tone
MHz	MHz mode
MARK	Position memory registration
DUAL	Setting the Dual/ Single band
APRS	APRS mode
OBJ	Object beacon transmission
ATT	Attenuator
FINE	Fine mode
POS	Position
BAND	Setting the Frequency band
MONI	Monitor
UP	Up
DOWN	Down

Setting the Transceiver PF Keys

There are 2 PF (Programmable Function) keys on the transceiver front panel: PF1 and PF2. You can assign your own desired functions to these 2 keys.

- 1 Access Menu No. 940 (PF1) or No. 941 (PF2) .

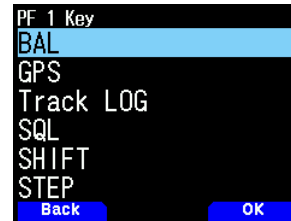

- 2 Select your desired function for the key.

Setting the Microphone Keys

There are 3 microphone PF (Programmable Function) keys: [PF1], [PF2], and [PF3]. You can assign your own desired functions to these 3 keys.

- 1 Access Menu No. 942 (PF1 Mic), Menu No. 943 (PF2 Mic), or Menu No. 944 (PF3 Mic).

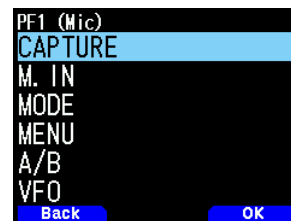

- 2 Select your desired function for the key.

KEY LOCK

The Key Lock function ensures that your transceiver settings will remain unchanged if you accidentally press a key.

To turn Key Lock On or Off, press and hold [F].

- When Key Lock is activated, the <  > indicator will appear on the display.



Selecting the Key Lock Type

Select a Lock type.

- 1 Access Menu No. 960.

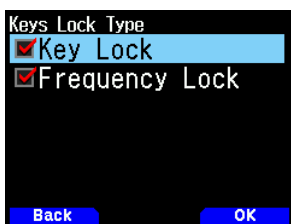

- 2 Select [Key Lock] and/or [Frequency Lock].

[Key Lock]: Locks all the front panel keys. (Press and hold [F] to unlock the keys.)

[Frequency Lock]: Locks the frequency or the memory channel. (The [MHz], [ENT], [MR], [BAND], Scan, [PF] (Group Up and WX) keys/functions cannot be used.)

[Key Lock] and [Frequency Lock]: Locks all the front panel keys along with the ENC control. (Press and hold [F] to unlock the keys.)

- The [MONI], [PTT], [⏻], and [VOL] control knob cannot be locked.

Setting the Microphone Key Lock

The Microphone Key Lock function will lock the microphone PF (Programmable Function) keys.

- 1 Access Menu No. 962.

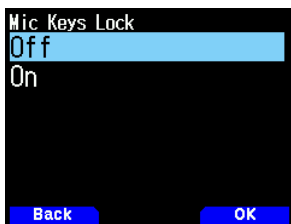

- 2 Select [On] or [Off].

VOLUME LOCK

This function locks the volume so that it cannot be changed inadvertently.

- 1 Use the [VOL] control to set the volume level you wish to lock.
- 2 Access Menu No. 963.

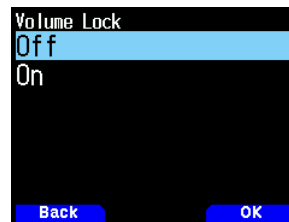

- 3 Select [On] or [Off].

- When [On] is set, the volume level at that time is locked. If the [VOL] control is turned while the volume is locked, "Locked Volume" appears.



Setting the Locked Volume Level

- 1 Use the VOL control to turn down the volume while pressing [MONI].
 - When a locked volume is set to a lower level, the lock is canceled temporarily.
- 2 Set the volume level you wish to lock and then release [MONI].
 - The new volume level is locked and [Completed VOL. Lock] appears.



DISPLAY UNIT

Setting the Speed, Distance

- 1 Access Menu No. 970.

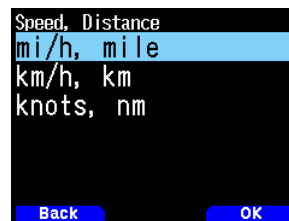

- 2 Select [mi/h, mile], [km/h, km], or [knots, nm].

Setting the Altitude, Rainfall

- 1 Access Menu No. 971.

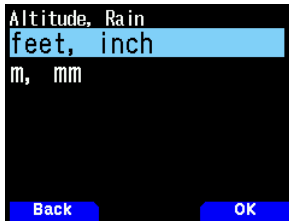

- 2 Select [feet, inch] or [m, mm].

Setting the Temperature

- 1 Access Menu No. 972.

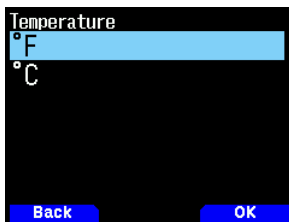

- 2 Select [°F] or [°C].

Setting the Latitude longitude

- 1 Access Menu No. 973.

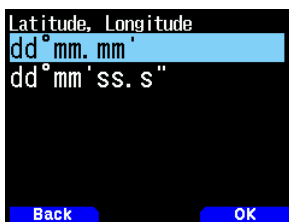

- 2 Select [dd°mm.mm'], or [dd°mm'ss.s''].

Setting the Grid Square Format

- 1 Access Menu No. 974.

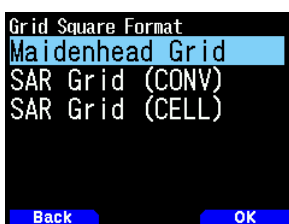

- 2 Select [Maidenhead Grid], [SAR Grid (CONV)], or [SAR Grid (CELL)].

[Maidenhead Grid]: This Grid Square format is commonly used in amateur radio.

[SAR Grid (CONV)]: Conventional format (old format) for Search & Rescue (old format) is used in the United States.

[SAR Grid (CELL)]: Cell format (new format) for Search & Rescue is used in the United States.

OUTPUT DESTINATION INTERFACE (USB/Bluetooth)

Set the interface to use for each of the following applications. Select [USB] or [Bluetooth].

- GPS data (NMEA) output
- APRS packet output
- KISS mode (input and output)
- DV/DR mode (input and output)
- DV Gateway mode (input and output)

Setting the PC Output (GPS) Interface

- 1 Access Menu No. 981.

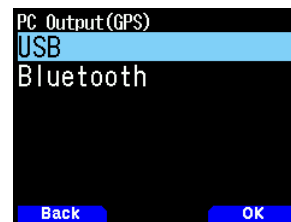

- 2 Select [USB] or [Bluetooth].

Setting the PC Output (APRS) Interface

- 1 Access Menu No. 982.

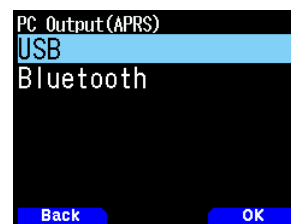

- 2 Select [USB] or [Bluetooth].

Setting the Data Band (KISS) Interface

- 1 Access Menu No. 983.

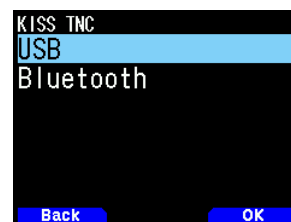

- 2 Select [USB] or [Bluetooth].

Setting the Data Band (DV/DR) Interface

- 1 Access Menu No. 984.

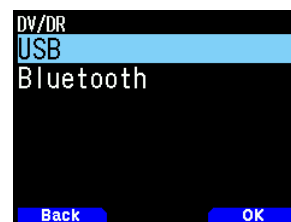

- 2 Select [USB] or [Bluetooth].

Setting the Data Band (DV Gateway) Interface

- 1 Access Menu No. 985.

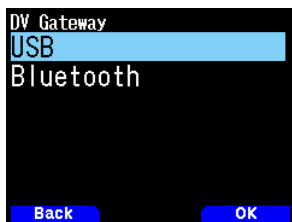

- 2 Select [USB] or [Bluetooth].

- The following describes the operation for each application when the output destination interface specifications are duplicated.

During GPS data output

- Output stops when the mode becomes KISS mode or DV/DR mode. Output resumes once KISS mode or DV/DR mode ends.
- Output stops if a PC command is accepted and then a GPS PC output setting (OFF) command or MCP command permission command is received.

During APRS packet output

- Output stops when the mode becomes KISS mode or DV/DR mode. Output resumes once KISS mode or DV/DR mode ends.
- Output stops if a PC command is accepted and then an APRS PC output setting (OFF) command or MCP command permission command is received.

During KISS mode

- A PC command is not accepted.
- Even if GPS/APRS PC output is turned ON, output is not performed. GPS/APRS PC output starts once KISS mode ends.
- When the mode becomes DV/DR mode, KISS mode ends.

During DV/DR mode

- A PC command is not accepted.
- Even if GPS/APRS PC output is turned ON, output is not performed. GPS/APRS PC output starts once DV/DR mode ends.
- Even if [F], [LIST] is pressed, the mode does not become KISS mode

During DV Gateway mode

- PC commands from the interface specified in PC input/output (DV Gateway) will not be accepted.
- If the PC output (GPS) and PC input/output (DV Gateway) are the same, NMEA sentences will not be output even if the GPS PC output is turned on.

SELECTING A LANGUAGE

You can select either English or Japanese.

- 1 Access Menu No. 990.



- 2 Select [English] or [Japanese].

VERIFYING THE FIRMWARE VERSION

You can verify your current transceiver firmware version.

- 1 Access Menu No. 991.

The current firmware version is displayed.



You can update the TH-D75A/E firmware by connecting the TH-D75A/E to the PC by using a commercially available USB cable.

The latest firmware is available for download from the following URL.

https://www.kenwood.com/i/products/info/amateur/software_download.html

(This URL may change without notice.)

TRANSCEIVER RESET

There are 3 types of transceiver reset available:

VFO Reset

Use to initialize the VFO and accompanying settings.

Partial Reset

Use to initialize all settings other than the Memory channels, and the DTMF memory channels.

Full Reset

Use to initialize all transceiver settings that you have customized. (Date and time are not reset.)

There are 2 ways to perform a reset on the transceiver: by key operation and by accessing Menu mode.

Key Operation

- 1 Turn the transceiver power OFF.
- 2 Press **[F] + Power ON** until reset screen appears.



- 3 Select your desired reset type: [VFO Reset], [Partial Reset], or [Full Reset].
- 4 Press **[A/B]** to set the reset type.
A confirmation message appears on the display.
- 5 Press **[A/B]** again to perform the reset.

Menu Mode

- 1 Access Menu No. 999.
- 2 Select your desired reset type: [VFO Reset], [Partial Reset], or [Full Reset].

Note:

- ◆ Press **[PF2] + Power ON** to set the voice guidance to Auto1 after Full Reset.

BUILT-IN GPS FUNCTION ON/ OFF

1 Access Menu No. 400

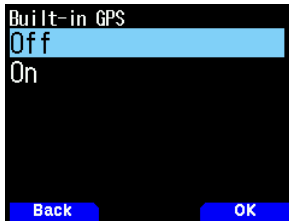

2 Select [On] or [Off].

[On]: Turns on the built-in GPS function.

[Off]: Turns off the built-in GPS function.



When the built-in GPS function is turned on, the GPS  indicator will be displayed.

When the built-in GPS receiver starts positioning, "GPS Locked" appears at the top of the display.

After that, the GPS  indicator will change to .

- When determining your position for the first time after the power supply is turned On, the clock data is automatically set and is updated once per day thereafter.

Note:

- ◆ "GPS Locked" appears at the top of the display only when you turn on the power or turn on the GPS function and start positioning for the first time.
- ◆ The GPS indicator on this transceiver does not flush.
- ◆ If you are inside a building or an underground mall and cannot measure the position, the  indicator changes to , and the last position data is retained until the next positioning. If you turn off the built-in GPS or turn off the power, the retained position data will be cleared.

Name entry

You can enter alphanumeric characters plus special ASCII characters (up to 8 digits).



Latitude Entry

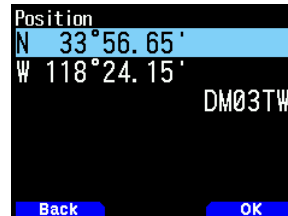

The north/ south latitude is entered.

Longitude Entry

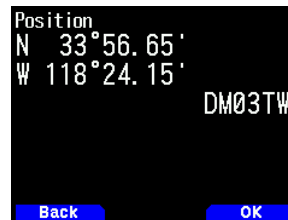

The west/ east Longitude is entered.

SETTING MY POSITION DATA

This transceiver has 5 memory channels for storing position data. Program latitude and longitude data for up to 5 locations from which you will often transmit APRS packets. You can also name the 5 memory channels.

1 Access Menu No.401.

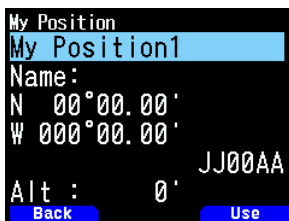

2 Select Position channel number 1 to 5.

When you press [A/B], the  indicator appears on the right side of the Position channel number.

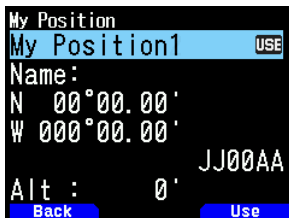

Position Ambiguity

There may be cases where you do not know or do not want to report your precise locations. For position data, you can select the number of digits not to be included in your packets. Select [1-Digit], [2-Digit], [3-Digit], [4-Digit], or [Off]. The table shows how the digits are cleared.

1 Access Menu No. 402

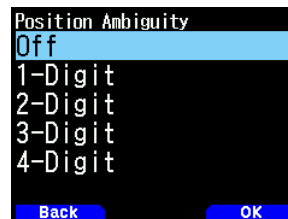

2 Select [Off], [1-Digit], [2-Digit], [3-Digit], or [4-Digit].

Off	1-Digit	2-Digit	3-Digit	4-Digit
33°50.43	33°50.4	33°50.	33°5.	33°.
118°13.72	118°13.7	118°13.	118°1.	118°.

Displaying Position Information

When the built-in GPS receiver is On, pressing [F], [MARK] will display "Latitude/longitude, time, altitude, heading, speed", then press [▶] to cycle the display between "Latitude/longitude, time, altitude, heading, speed" → "Target point distance, Travel direction" → "GPS satellite information".

- Press [◀] returns to the previous display.

Latitude/longitude, Time, Altitude, Heading, Speed

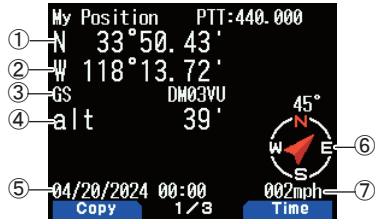

- ① Latitude ② Longitude ③ Grid square locator ④ Altitude
⑤ Time ⑥ Heading ⑦ Speed

Target point distance, Target direction



- ① Target direction ② Target point distance
- When pressing [F] while the target point distance/ target direction is displayed, the North Up display (displays North as the top) changes to the Heading Up display (displays the current travel direction as the top) or vice-versa. In the Heading Up display, a "+" or "-" is used to help indicate the traveling direction.

GPS satellite information

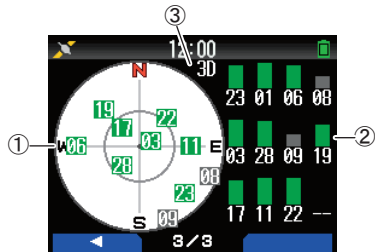

- ① Sky view ② Satellite signal-strength bars
③ 2D: Latitude/Longitude positioning
3D: Latitude/Longitude and Altitude positioning
- The sky view shows the satellites you are receiving. The satellite signal-strength bars indicate the strength of each satellite you are receiving. A solid bar indicates that the GPS satellite is ready for use.
 - When only the frame of the signal-strength bar is displayed, no contact with the satellite has yet been made

Note:

- When GPS cannot be received, turn the power ON in a clear environment (Open Sky).

Built-in GPS Operation Mode

- Access Menu No. 403.

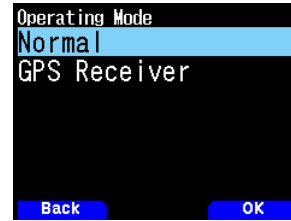

- Select [Normal] or [GPS Receiver].
- Press [A/B] to restart the transceiver with the selected mode.

[Normal]: The display continues to show your frequency. You can use it as a normal transceiver.

[GPS Receiver]: The display shows only GPS information. The transceiver transmit and receive capabilities are turned OFF, and only GPS operation is available.

GPS Receiver mode display

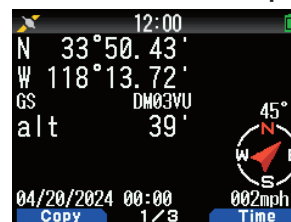

Key Operation in GPS Receiver Mode

When set to [GPS Receiver], you can operate only the following key functions.

Key operations in [Latitude/longitude, Time, Altitude, Heading, Speed]

Key Name	Operation
[◀]	Switches to FM radio frequency screen when FM radio mode is On.
[▶]	Switches to [Target point distance and Heading] screen.
[MODE]	Switches to [Latitude and Longitude] copy selection screen.
[MENU]	Switches to the menu screen.
[A/B]	Switches to [Time] copy confirmation screen.
[F]	Switches between the North up and the Heading up.
[MARK]	Press [MARK]: Switches Mark waypoint list. Press and hold [MARK]: Switches to the registration mode of mark position.

Key operations in [Target point distance, Target direction]

Key Name	Operation
[◀]	Switches to [Time, Altitude, Heading, and Speed] screen.
[▶]	Switches to [GPS satellite information] screen.
[MODE]	Switches to [Time, Altitude, Heading, and Speed] screen.
[MENU]	Switches to the menu screen.
[A/B]	Switches to [GPS satellite information] screen.
[F]	Switches between the North up and the Heading up.
[MARK]	Press and hold [MARK]: Switches to the registration mode of mark position.

Key operations in [GPS satellite information]

Key Name	Operation
[◀]	Switches to [Target point distance and Target direction] screen.
[▶]	Switches to FM radio frequency screen when FM radio mode is On.
[MODE]	Switches to [Target point distance and Target direction] screen.
[MENU]	Switches to the menu screen.
[A/B]	Switches to FM radio frequency screen when FM radio mode is On
[MARK]	Switches to the registration mode of mark position.

Battery Saver (GPS Save)

This function will turn the GPS power source Off after the programmed timer expires if position data is not determined during the maximum catching time (approximately 5 minutes). To prevent unnecessary battery consumption, when there are many reception satellites, the GPS is stabilized and position data can be determined, the GPS power source repeatedly turns On and Off.

1 Access Menu No. 404.



2 Select [Off], [1], [2], [4], [8] minutes, or [Auto].

[Off]: The built-in GPS receiver function is always On.

[1 min] to [8 min]: When set to 1, 2, 4, or 8 minutes, the GPS off time starts at the selected duration if position data is not determined during the maximum catching time (approximately 5 minutes).

[Auto]: When set to Auto, the GPS Off time starts at 1 minute for the first time, then progresses to 2 minutes, 4 minutes and 8 minutes each additional time. The GPS Off time remains at 8 minutes thereafter. However, after having determined your position for the duration, if the GPS cannot pinpoint your location, the GPS Off time will restart at 1 minute.

Note:

- ◆ Position precision may be improved by setting the Battery Saver (GPS Save) function to [Off].
- ◆ When GPS cannot be received, turn the power ON in a clear environment (Open Sky).

GPS Data PC Output

Turn this function on when you want to send the built-in GPS receiver data (NMEA) from the USB connector or Bluetooth.

1 Access Menu No. 405.

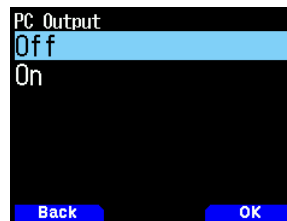

2 Select [Off] or [On].

[Off]: The built-in GPS receiver data (NMEA) is not output from the USB connector or Bluetooth.

[On]: The built-in GPS receiver data (NMEA) is output from the USB connector or Bluetooth.

Note:

- ◆ When the built-in GPS receiver data (NMEA) is output, the communication speed (baud rate) is maximum 12 Mbps for USB and maximum 128 kbps for Bluetooth.
- ◆ You can select USB or Bluetooth by Menu No. 981.

Sentence

Configure the built-in GPS receiver data (NMEA) output to the PC.

1 Access Menu No. 406.



2 Select [\$GPGGA], [\$GPGLL], [\$GPGSA], [\$GPGSV], [\$GPRMC], and/or [\$GPVTG].

3 Press [ENT].

Each press adds or removes a check mark.

4 Press [A/B].

Note:

- ◆ You cannot remove all sentences.

MARK FUNCTION

You can register up to 100 points with the location's latitude, longitude, altitude, time, name, and icon in the Position Memory List.

- 1 Press and hold **[MARK]**.

The position memory store screen appears.

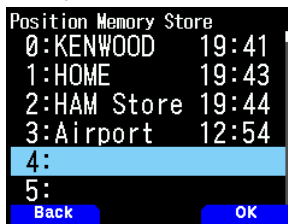

- 2 Select a position memory number.

- 3 Press **[ENT]**.

The location information is registered.

When Overwriting

When selecting the already registered position memory number, the overwrite confirmation screen appears.

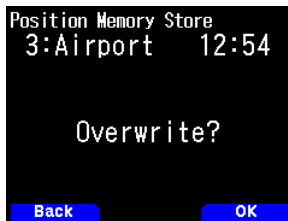

- 4 Press **[A/B]**.

The location information is overwritten.

POSITION MEMORY LIST

You can register the following location information up to 100 points in the Position Memory List.

You can edit all information except Registration time manually.

- Position name
- Icon (same as APRS)
- Registration time
- Longitude
- Latitude
- Altitude

Checking Registered Position Memory

- 1 Press **[MARK]**.

The position memory list screen appears.



- 2 Select a list.

- 3 Press **[ENT]**.

The position memory list details screen appears. Details of the position memory can be checked.



- When pressing **[F]**, the North Up display (displays North as the top) changes to the Heading Up display (displays the current travel direction as the top) or vice-versa.
- 4 Press **[MODE]**.

The position memory list screen reappears.

Editing Position Memory

- 1 Press **[MARK]**.

The position memory list screen appears.

- 2 Select a list.

- 3 Press **[MENU]**.

The position memory list menu screen appears.

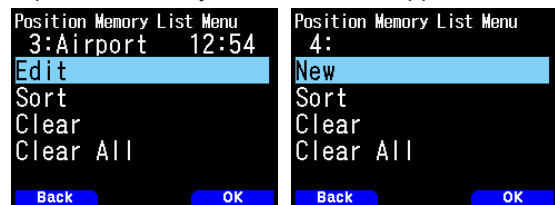

- 4 Select [Edit] or [New] and press **[A/B]**.

The mode changes to position memory edit mode. The edit menu items are as follows.

- Name (position name)
- Position (latitude and longitude)
- Icon
- Altitude

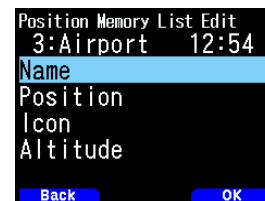

Editing the Name (Position Name)

- 1 Select [Name] and press **[A/B]**.

The character input screen appears.

- 2 Select the characters.

For the detailed character input procedure, refer to page No.6-1 "CHARACTER ENTRY".



Editing the Position (Latitude and Longitude)

- 1 Select [Position] and press [A/B].
The mode changes to the latitude and longitude edit mode.

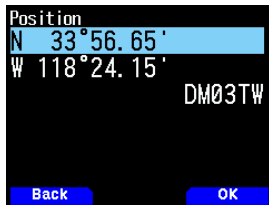

- 2 Select [N]/[S] or [E]/[W], and press [ENT].
[N]/[S]: Edits the latitude.
[E]/[W]: Edits the longitude.

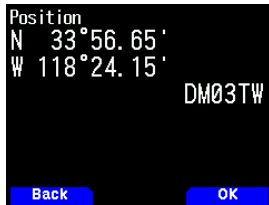

Key Name	Operation
[▲]/[▼] or [ENC]	Changes the item.
[◀]/[▶]	Moves the cursor.
[ENT]	Confirms the editing.
[MODE]	Cancels editing and returns to the previous screen.

Editing the Icon

- 1 Select [Icon] and press [A/B].
The mode changes to the icon setting mode.

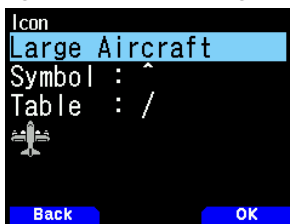

Key Name	Operation
[▲]/[▼]	Switches the station icon.
[ENT]	Cursor moves to [Symbol].
[A/B]	Confirms the station icon.

- 2 Select [Symbol] or [Table] and press [ENT].
[Symbol]: Edits the symbol.
[Table]: Edits the table code.

Key Name	Operation
[▲]/[▼]	Switches to [Symbol] or [Table].
[ENT] or [A/B]	Changes to the selected setting mode.
[MODE]	Returns to the station icon selection.

Editing the Altitude

- 1 Select [Altitude] and press [A/B].
The mode changes to the altitude setting mode.



Key Name	Operation
[▲]/[▼] or [ENC]	Changes the item.
[ENT]	Confirms the editing.
[MODE]	Cancels editing and returns to the previous screen.

Sorting Position Memory List

- 1 Press [MARK].
The position memory list screen appears.
- 2 Select a list.
- 3 Press [MENU].
The position memory list menu screen appears.

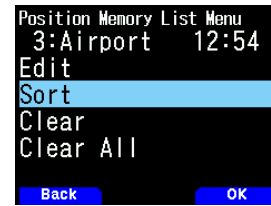

- 4 Select [Sort] and press [A/B].

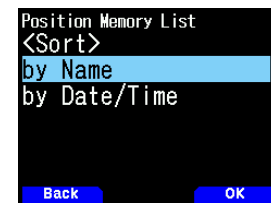

- 5 Select [by Name] or [by Date/Time] and press [A/B].
[by Name]: Sorts in name order.
[by Date/Time]: Sorts in date and time order.

Clearing Position Memory

- 1 Press [MARK].
The position memory list screen appears.
- 2 Select a list.
- 3 Press [MENU].
The position memory list menu mode screen appears.

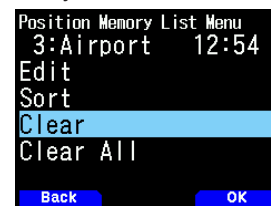

- 4 Select [Clear] or [Clear All].
[Clear]: Clears the selected position memory.
[Clear All]: Clears all position memories.
- 5 Press [A/B].

The clear confirmation screen appears.



- 6 Press [A/B] to clear the position memory.

TARGET POINT

You can register positional information for a target point.

1 Press **[MARK]**.

The position memory list screen appears.



2 Select a position memory number.

3 Press **[A/B]**.

The "in use" target point mark **< TP >** appears to the right of the time. The target point mark disappears when pressing **[A/B]** again.



Target Point Distance and Target Direction

1 Press **[F]**, **[MARK]**

2 Press **[▶]**.

[Target point distance and Target direction screen] appears. When pressing **[F]** while the target point distance and target direction are displayed, the North Up display (displays North as the top) changes to the Heading Up display (displays the current travel direction as the top) or vice-versa.



TRACK LOG

All movement is saved in the GPS LOGGER in the microSD memory card.

1 Access Menu No. 410.

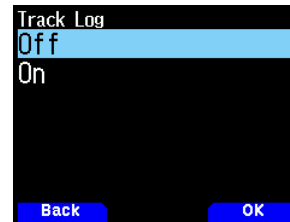

2 Select to **[On]**.

- When the built-in GPS receiver is On, the **< ST >** indicator appears on the display during positioning. Track Log will be recorded when the transceiver is in positioning status.
- With the Track Log function On, even if the power source is turned Off during a Log acquisition, the log is backed up so that when the power is turned back on, the log acquisition resumes.

Note:

- ◆ When the Track Log is turned On while the GPS function is Off, the GPS function will also turn On.
- ◆ When the GPS function is not pinpointing, Track log is not saved.
- ◆ If the Track Log overwriting configuration is turned Off (see below), "LOG FULL" appears when the log memory is full.
- ◆ When the APRS is On, Log operation will begin only when the APRS menu COM terminal input is Off.
- ◆ When the microSD memory card runs out of space, Track log function is paused.
- ◆ The files stored on the microSD memory card are named as Track Log started date.
Example: TH-D75A:05122024_124705.nme (File for which track logging started at 12:47:05 on May 12 2024.)
TH-D75E:12052024_124705.nme (File for which track logging started at 12:47:05 on 12 May 2024.)

Selecting the Track Log Acquisition Type

You can set the conditions for saving portable Track information as GPS Logger.

You can change the settings for travel speed, etc.

- 1 Access Menu No. 412.



- 2 Select [Time], [Distance], or [Beacon] for the Record Method.
- 3 Access Menu No. 413.

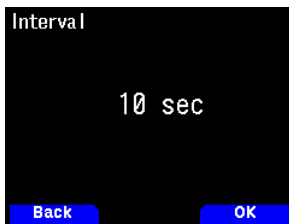

- 4 Select the Interval time from [2] to [1800] seconds (in steps of 1 second).

- 5 Access Menu No. 414.

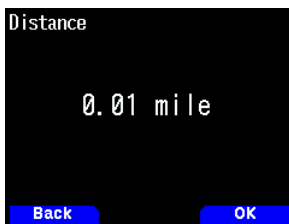

- 6 Select the Distance from [0.01] to [9.99] (in steps of 0.01).

Interval and Log Total Time

Point Q'ty	Interval time (second)					
	2	5	10	15	30	2800
5000	166.7	416.7	833.3	1250	2500	150000 (min)
	2.8	6.9	13.9	20.8	41.7	2500 (hour)

Interval and Total Distance

Point Q'ty	Interval distance (km)						
	0.01	0.10	2.00	4.00	6.00	8.00	9.99
5000	50	500	10000	20000	30000	40000	49950 (km)

Note:

- ◆ The Interval setting is available only if the Record Method has been set to [Time].
- ◆ The Distance setting is available only if the Record Method has been set to [Distance].
- ◆ The units used for Distance can be set to miles (mile), kilometers (km) or nautical miles (nm).

Clearing the Track Log

Clear a Track Log saved in a microSD memory card.

- 1 Access Menu No. 411.

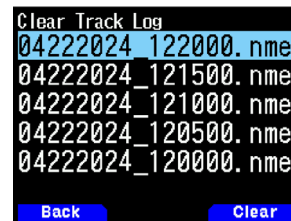

- 2 Select the file to clear.

- 3 Press [A/B].

- If you delete all files, press and hold [A/B].

A confirmation message appears on the display.

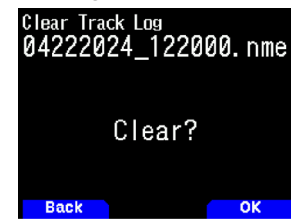

- 4 Press [A/B].

The file is deleted.

- 5 Press [MENU].

The frequency screen reappears.

APRS DATA COMMUNICATION

- This function uses the APRS format for data communications including your station position, messages, etc.
- When data is received from another station directly, via digipeaters and/or IGate stations, the direction of the received station (from your station's perspective), their distance, and their grid square locator is displayed. Any comments sent by the other stations are also displayed.
- APRS (Automatic Packet Reporting System) is a worldwide system introduced by Mr. Bob Bruninga (WB4APR: SK).
< The APRS® trademark is used with permission of Tucson Amateur Packet Radio Corp., its assignee.>
Official APRS Website: <http://www.aprs.org>

APRS Network

Digipeater

- Digipeater (Digital Repeater) relays digital packet data. When a Digipeater receives a packet, it saves it to memory. When the reception ends, the packet data is re-transmitted on the same frequency. Using Digipeaters, it is possible to exchange APRS packets long distances.

IGate

- IGate (Internet Gateway) is a very useful and important feature for APRS as well as Digipeater. IGate stations bridge APRS packets between RF and the Internet. By going through the IGate stations, you can enjoy the communication with the further distant stations which are not covered only by Digipeaters.

Digipeater stations and IGate stations are operated by the volunteer people in each region.

BASIC SETTINGS

This section describes only the basic items required for general operation as an APRS mobile station from the default setting state. For other operations and settings, please read this instruction manual in detail and fully understand the contents before operation. Inappropriate operations and settings may cause adverse impact to the APRS network.

My Callsign

Program your Callsign using a maximum of 9 alphanumeric characters including SSID (Secondary Station IDentifiers) such as -7, -9, or -14. Unless you program a Callsign, you cannot transmit APRS packets.

- 1 Access Menu No. 500.

The display for entering a Callsign appears.

You can enter 0 to 9, A to Z, and -.



- 2 Press [ENT] to set the Callsign.

Note:

- ◆ For SSID characters, refer to the guideline on the Website (<http://aprs.org/aprs11/SSIDs.txt>) by Mr. Bob Bruninga.
- ◆ When all settings are blank, "NOCALL" is automatically set. In this case, the Position packet or Message packet cannot be transmitted.

Your Station Icon

- 1 Access Menu No. 501.









































- 2 Select an icon which will be displayed on the monitors of other stations as your ID. You may select an icon depending on your current location. It is important that the icon conveys the operational status of the station as well as the SSID.









- 3 Press [A/B] to set your station icon.

Icon List

	Person	(/I)
	Bicycle	(/b)
	Motorcycle	(/<)
	Car	(/>)
	Bus (/U)	(/U)
	Railroad Engine	(/=)
	Home	(/-)
	Yagi@QTH	(/y)
	KENWOOD	(\K)
	RADIO	(\Y)
	RV (/R)	(/R)
	Van (/v)	(/v)
	Jeep (/j)	(/j)
	Truck (/k)	(/k)
	Truck (18-wheeler) (/u)	(/u)
	Police	(/P)
	Ambulance	(/a)
	Canoe	(/C)
	Boat	(/s)
	Sailboat	(/Y)

	Balloon	(/O)
	Glider	(/g)
	Helicopter	(/X)
	Aircraft	(/l)
	Large Aircraft	(/^)
	Shuttle	(/S)
	Satellite	(\S)
	Rover	(/p)
	Eyeball	(/E)
	Portable (Tent)	(/:)
	HAM Store	(\h)
	School	(/K)
	Hospital	(/h)
	Red Cross	(/+)
	Lighthouse	(\L)
	Speedpost (Value Singpost)	(\m)
	WorkZone	(\j)
	Wreck/Obstruction	(/x)
	Sheriff	(/!)
	Fire	(/:)
	Sunny	(\U)
	Gale Flags	(\g)
	Tornado	(\t)
	National WX Service Site	(/W)
	WX (Weather Station)	(/_)
	Digipeater	(/#)
	Mic-E Repeater	(/m)
	QSO Repeater	(/r)
	Circle	(/O)
	IRLP	(/O)
	EchoLink	(E0)
	Node	(/n)
	GATEWay	(/&)
	DF station	(/\)
	Dish Antenna	(/')
	PC User	(/L)
	SSTV	(/T)
	ATV	(/V)
	BBS	(/B)

	APRSSt	(\A)
	X	(/.)
	Triangle	(\n)
	Small Circle	(\o)
	Red Dot	(//)
	Big Question Mark	(\.)

Overlay Character Setting

For example, to set the Radio icon to the letter “K”, select “Radio” under the icon type Menu No., then select “K” under “Table”.



Note:

- ◆ APRS icon codes (symbols/tables) are sometimes updated. Please refer to the following official APRS website:
<http://www.aprs.org/symbols/symbolsX.txt>
<http://aprs.org/symbols/symbols-new.txt>
- ◆ Set an icon that represents your operational status. (For example, setting an Aircraft icon or Balloon icon to a fixed station will cause confusion when a station receives a beacon.)

POSITION COMMENT

The APRS data which you transmit always includes one of the 15 predetermined position comments. Select an appropriate comment depending on your situation.

Selecting a Position Comment

- 1 Access Menu No. 502.

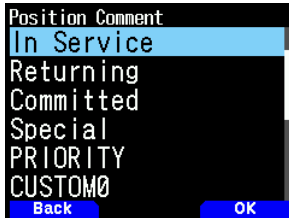

The selectable comments are listed below:

[Off Duty], [Enroute], [In Service], [Returning], [Committed], [Special], [PRIORITY], [CUSTOM 0 ~ CUSTOM 6], or [EMERGENCY!]

- If you select [EMERGENCY!], a confirmation message appears. Press [A/B] again.

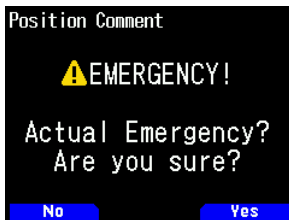

ATTENTION

- ◆ When it is unnecessary, never select [EMERGENCY!]. When an emergency signal is received using APRS, the Emergency Alarm on all stations will sound.

STATUS TEXT

Status text is another comment to transmit with position data. Unlike a position comment, you can make any desired comment using a maximum of 42 alphanumeric characters. This transceiver has 5 memory channels for preprogramming.

Storing Status Text

- 1 Access Menu 503.

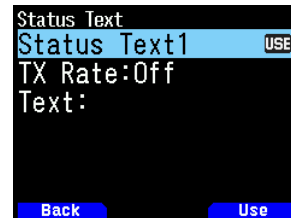

- 2 Select a status text number.

- Press [A/B] to mark the currently used status text with <USE>.

- 3 Select the proportion of times to transmit the status text when the APRS beacon is transmitted. You can select [Off] or [1/1] ~ [1/8].

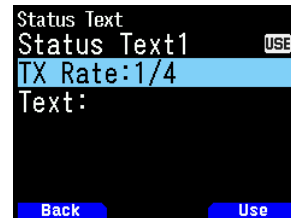

- 1/X means the status text will be transmitted X number of times.

- 4 Enter your status text.



Setting the Data Band Frequency

Set the data band frequency to the APRS network frequency. The default setting of the data band is band A.

You can change the data band to band B by Menu No. 506.

Note:

- ◆ The APRS network frequency will depend on what region of the world you are operating as follows:
 - North America: 144.390 MHz, Europe: 144.800 MHz
 - Australia: 145.175 MHz, New Zealand: 144.575 MHz
 - Argentina: 144.930 MHz, Brazil: 145.570 MHz
 - Japan: 144.640 MHz (9600 bps)/ 144.660 MHz (1200 bps)

Setting APRS Data Communication ON

Press [F], [LIST] to enter APRS mode.

Each time a new APRS packet is received, the frequency display is interrupted to show information as below.

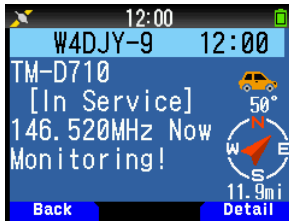

To return to the frequency screen, press any key except [▶] or [A/B], or just wait for approximately 10 seconds.

- When you receive an APRS packet including an "Emergency" comment, a different format of display from the above will appear and a different beep will sound.



- You can change the interrupt screen display setting through Menu No. 573 (Display Area). When set to [One Line], the frequency display is not interrupted. An indicator such as "nP" appears depending on the types of data. Refer to the table.



Indicator	Meaning
dP	Duplicate position comment
nP	New position data
oP	Other station position data
>P	Beyond position limit
>F	Beyond filter type
aM	ACK message
dM	Duplicate message data
nM	New message data
oM	To other stations message data
rM	Rejected Message
dS	Duplicate status text
nS	New status
Q?	Query
??	Packet that cannot be decoded
dD	Duplicated DX cluster data
nD	New DX cluster data

Note:

- The APRS programs for PCs have entry fields for a position comment and status text. The data entered to these two fields are transmitted as separate packets. This transceiver, however, includes both of a position comment and status text in one packet to transmit.
- This transceiver beeps each time it receives any type of APRS packet. You may access Menu 570 (Sound - RX Beep) to change this setting. The default is [All].

Transmitting APRS Beacon

Press [BCN] to transmit your APRS beacon (position packet). <BCON> icon is displayed and APRS beacon is automatically transmitted.

- When you receive an APRS beacon that you transmitted, the frequency screen is interrupted and "My Position" will appear on the display. This could happen when one or more digipeaters are used.



STATION LIST

This transceiver is capable of receiving and storing APRS data received from up to 100 stations in memory. You can easily recall the information of the desired station.

1 Press **[LIST]** to show the list of stations.

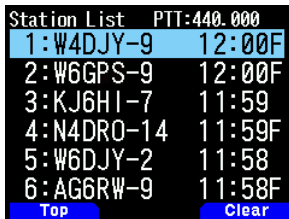

2 Press and hold **[LIST]** to change the list type to [Callsign + model name], [Callsign + Time + QSY].

Key functions for station list are as follows.

Key Name	Operation
[ENC]	To select a station data.
[▲]	To move the cursor to the small list number (New receiving station).
[▼]	To move the cursor to the big list number (Old receiving station).
[ENT]	To enter the details of the selected station.
[MODE]	To move the cursor to the top list number.
[MENU]	To enter the station list menu.
[A/B]	To delete the selected station data.
[◀]	To return to the frequency display.
[PTT]	To switch to the frequency display and transmit.
[LIST]	To return to the frequency display. Press [LIST] (1s): To change the list type.

3 Press **[ENT]** to select the desired station.

The details of station data are displayed.



Key functions for station data are as follows.

Key Name	Operation
[ENC]	To select a station data.
[MODE]	To move the cursor to the top list number.
[◀]	To return to the station list.
[▶]	To display the next page.
[A/B]	To delete the selected station. When "Clear ?" appears, press [ENT] to clear. Press and hold [A/B] : To delete all stations. When "Clear All ?" appears, press [ENT] . And when "Sure ?" appears, press [ENT] again to clear all.
[MENU]	To enter the station list menu.
[PTT]	To switch to the frequency display and transmit.
[LIST]	To return to the frequency display.

Note:

- ◆ When data from the 101st station is received, the oldest data in memory is replaced by that data.
- ◆ Each time a new APRS packet is received from the same station, the old data from that station (in memory) is replaced by new data.

Display Examples

Page 1:

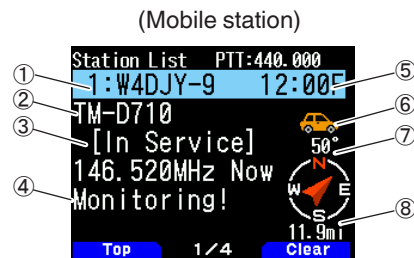

- 1 Callsign
- 2 Situation
- 3 Position comment
- 4 Status text
- 5 Time
- 6 Station icon
- 7 Direction of the station
- 8 Distance from the station

Page 2:

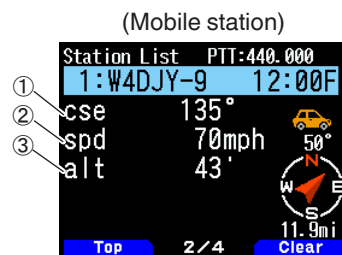

- 1 Moving direction
- 2 Moving speed
- 3 Altitude

(Weather station)

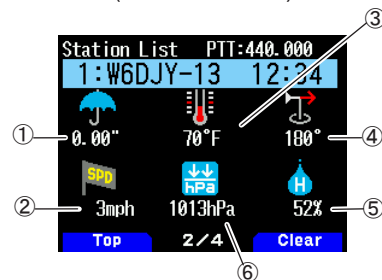

- 1 Rainfall
- 2 Wind velocity
- 3 Air temperature
- 4 Wind direction
- 5 Humidity
- 6 Atmospheric pressure

Page 3:

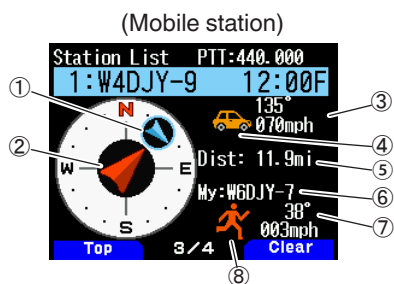

- ① Direction and moving direction of the other station
- ② Moving direction of my station
- ③ Speed and moving direction of the other station
- ④ Station icon of the other station
- ⑤ Distance of the other station
- ⑥ My Callsign
- ⑦ Speed and moving direction of my station
- ⑧ My station icon

Page 4:

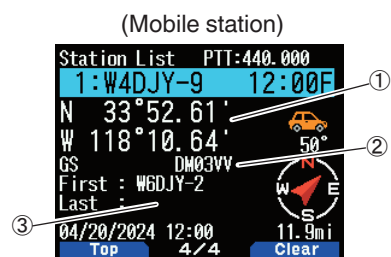

- ① Latitude, Longitude
- ② Grid square locator
- ③ Packet path (Digipeated route)

② Situation in Page 1:

Display	Description
Fixed	Fixed station
Weather	Weather station
Moving	Mobile station
GOOD/RMC	GPS Tracker
LAST/RMC	
GOOD/GGA	
LAST/GGA	
GOOD/GLL	
LAST/GLL	
MicE	Station for transmitting positional information packet with MicEncoder format.
MicE-MSG	Station for transmitting positional information packet with MicEncoder. <message capable>
Object	Object data
ID	ID packet
Status	Status packet
Telemetry	Telemetry packet
Ccompress	Compressed format data
GRID-SQ	Grid Square format data
TH-D7	TH-D7 station
TH-D72	TH-D72 station
TH-D74	TH-D74 station
TH-D75	TH-D75 station
TM-D700	TM-D700 station
TM-D710	TM-D710G/ TM-D710/ RC-D710 station
VX-8	VX-8 station
VX-8G	VX-8G station
FT1D	FT1D station
FT2D	FT2D station
FT3D	FT3D station
FT5D	FT5D station
FTM-100D	FTM-100D station
FTM-200D	FTM-200D station
FTM-300D	FTM-300D station
FTM-350	FTM-350 station
FTM-400D	FTM-400D station
FTM-500D	FTM-500D station

Cursor Control

Select a cursor control setting for station list screen.

- 1 Press **[MODE]** to change the cursor control type to [Followed] or [Fixed].

[Followed]: The Callsign with the indicating cursor will be followed. On the detailed list screen, the selected Callsign continues to be displayed.

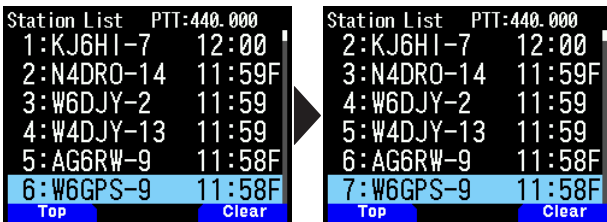

[Fixed]: < > (Pin symbol) appears at the left of list number "1" (latest). The cursor will always be fixed at the latest station. The list number is also fixed at "1" on the detail screen and the latest station is displayed.

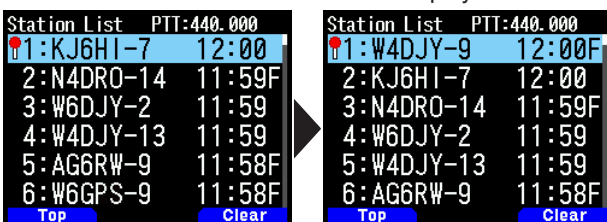

Clearing the APRS Station

This function allows you to display only the specified types of data from the station list.

- 1 Press **[LIST]** and display the list of stations.
- 2 Select the specified station.
- 3 Press **[MENU]** and display the station list menu.
- 4 Press **[▲]/[▼]** or rotate the **[ENC]** control to select [Clear] or [Clear All].

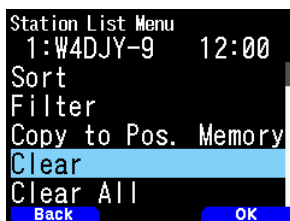

[Clear]: Deletes the selected station

[Clear All]: Deletes all stations.

- 5 Press **[A/B]**.
"Clear?" or "Clear All?" appears
- 6 Press **[A/B]** to clear station.

Sort Function

This function allows you to sort the station list according to the Callsign, date time, or distance.

- 1 Press **[LIST]** to show the list of stations.

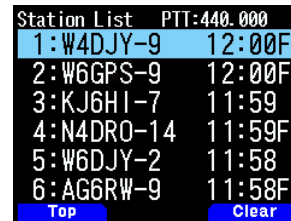

- 2 Press **[MENU]**.

The station list menu appears.

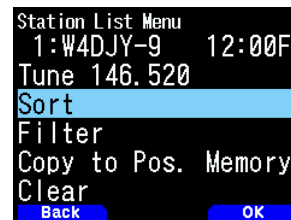

- 3 Select [Sort].

The sort type list appears.

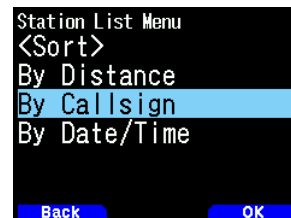

- 4 Press **[▲]/[▼]** or rotate the **[ENC]** control to select a sort type, and press **[A/B]**.
 - "Sorting!" appears on the display and sorting begins.

[by Distance]	The distance between the other station and My station when selecting the sorting method is calculated, then compared and arranged in ascending order, with the closest station listed first.
[by Callsign]	All Callsigns are compared and arranged in ascending order.
[by Date/Time]	All received dates and times are compared and arranged in descending order, with the last received message listed first.

- 5 The newly sorted station list appears on the display. Below is an example sorted by Callsign.

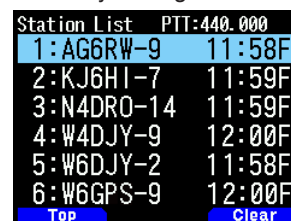

Note:

- ◆ After sorting, when new station data is received, it is added to the station list without resorting.

Filter Function

This function allows you to display only the specified types of data from the station list.

- 1 Press **[LIST]** and display the list of stations.
- 2 Press **[MENU]** and display the station list menu.

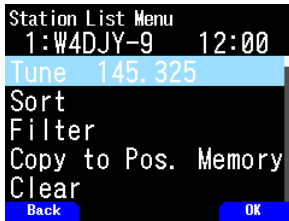

- 3 Press **[▲]/[▼]** or rotate the **[ENC]** control to select **[Filter]**, and press **[A/B]**.

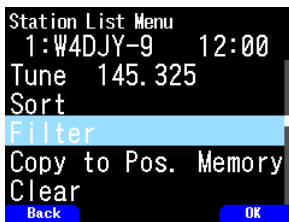

- The filter type list appears on the display.



- 4 Press **[▲]/[▼]** or rotate the **[ENC]** control to select a filter type, and press **[A/B]**.

- “Filtering” appears on the display and filtering begins.

All(Off)	The filtering function is cancelled, displaying all stations.
Digipeater	Only Digipeater Stations are displayed.
Weather	Only Weather Stations are displayed.
Mobile	Only Mobile Stations are displayed.
Object	Only Object Stations are displayed.
KENWOOD	Only KENWOOD TH-D75, TH-D74, TH-D72, TH-D7, TM-D700, TM-D710G, TM-D710, and RC-D710 Stations are displayed.
NAVITRA	Only Navitra Stations starting from \$PNTS are displayed.
QSY (Freq)	Only stations containing frequency (QSY) data are displayed.
1-Way	Only the message incapable MicEncoder format stations and the GPS trackers are displayed.
Others	Stations other than those listed above are displayed.

- 5 The newly filtered station list appears on the display.
 - After the display filter function is turned ON, received data is added to the list but will not be displayed if it matches the filter type selected.
 - For example, with the station list displayed and the display filter selection set to **[Weather]**, all stations not relating to weather are no longer displayed. If mobile station data is received at this time, the new data will also not be displayed as long as the weather filter is active.

Copy to Position Memory

If position data is available within the station list, the position data to copy to the Position Memory list.

- 1 Press **[LIST]** and display the list of stations.
- 2 Select a station list.
- 3 Press **[MENU]** and display the station list menu.
- 4 Select **[Copy to Pos. Memory]**.

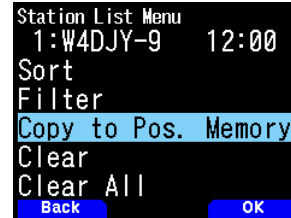

- 5 Press **[A/B]**.

The position memory store screen appears.

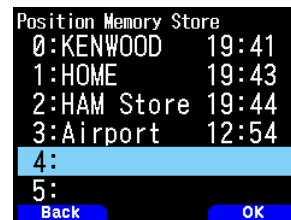

- 6 Select a position memory number.

- 7 Press **[A/B]**.

The position data is registered.

Clearing APRS Station Memory

- 1 Press **[LIST]** and display the list of stations.
- 2 Select a station.
- 3 Press **[MENU]** and display the station list menu.
- 4 Select **[Clear]** or **[Clear All]**.

[Clear]: Clears the selected station memory.

[Clear All]: Clears all station memories.

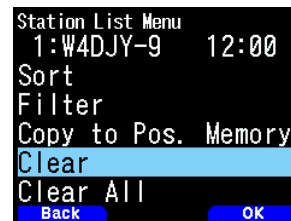

- 5 Press **[A/B]**.

The clear confirmation screen appears.



- 6 Press **[A/B]** to clear the station memory.

APRS MESSAGE FUNCTIONS

Receiving a Message

Each time a proper message is received, the frequency display is interrupted to show information as below:

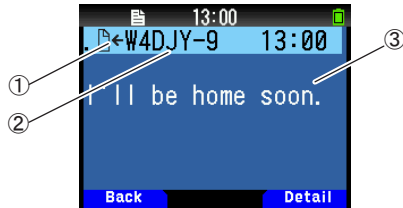

① Meaning indicator ② Callsign (Sender) ③ Message

Key Name	Operation
[◀] [MODE]	To return to the frequency display.
[▶]	To move to the detail screen.
[A/B]	To move to the message screen.

Meaning	
	Message addressed to you
B	Bulletin message
!	Report by the National Weather Service
*	A message for which a reception acknowledgment was returned
G	Group message

- When a duplicate message from the same station is received, the reception interrupt display does not appear and an error tone sounds. When the frequency at that time appears on the display, "dM" (duplicate Message) and the calling station's Callsign appears on the display.

Entering a Message

- Press [MSG].

The message list appears on the display.

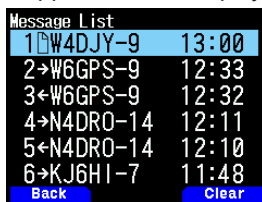

Key Name	Operation
[ENC]	To select a list number.
[◀]	To return to the frequency display.
[▶]	To move to the detail screen.
[A/B]	To delete the message on the cursor.

- Select a list number by [ENC] control and press [▶].

The message list menu appears on the display.

First page:

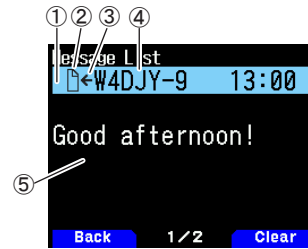

Last page:

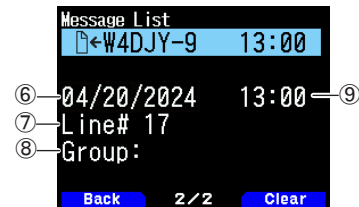

- TX Message status
- Meaning indicator
- Receiving message/sending message
- Callsign
- Message
- Receive date
- Line number
- Message group
- Receive time

- The display shows up to 67 characters of the message.
- The following indicators appear depending on the types of received messages.

a TX Message status	
n	"n" indicates the remaining number of times for transmitting the message
*	A message for which a reception acknowledgment was returned
.	A message transmitted 5 times (For a message, a reception acknowledgment was not returned)
b Meaning	
	Message addressed to you
B	Bulletin message
!	Report by the National Weather Service
G	Group message
c RX or TX	
←	Received message
→	A message for transmitting

Transmitting a Message

1 Press [MSG].

The message list appears on the display.

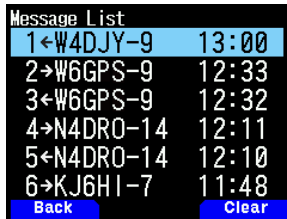

2 Press [MENU].

The message list Menu appears on the display.

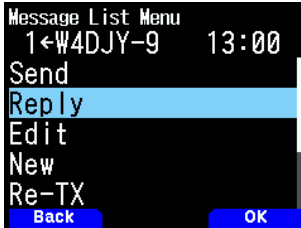

3 Select [Reply], [Edit], or [New].

- When selecting [Edit], the original message is quoted and you can edit it.
- Enter the Callsign when selecting [New].

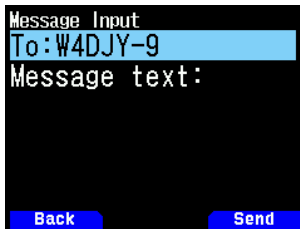

4 Enter the message

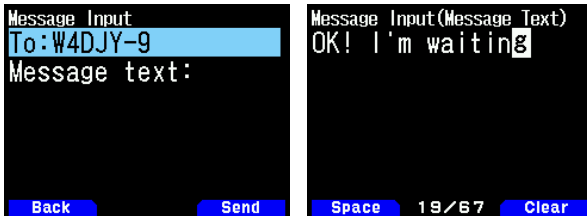

Key Name	Operation
[ENC]/[▲]/[▼]	To select a character.
[◀]	To move the cursor backward.
[▶]	To move the cursor forward.
[A/B]	To delete the message on the cursor.

Note:

- ◆ When using the already registered user phrases, refer to the following step 5.

5 Enter the user phrase.

Press [F] to enter the message compilation mode.

You can select the user phrase among the already registered user phrases by Menu No. 560.

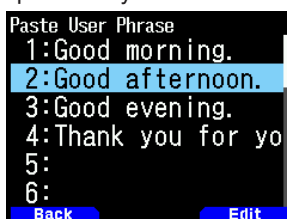

6 Select [Send] and press [A/B] to send the message.

You can select the following items other than [Send], [Reply], [Edit], and [New] in message list Menu.

[Re-TX]: Send the message again.

[Position]: Search position information from a position list.

[POS Request]: The position data of the transmitting station is displayed (if the station data is available).

[Unread]: Change the existing reading message to unread message.

Storing User Phrases

This function (clipboard image) allows you to paste phrases into the APRS message compilation mode. You can create up to 20 phrases each of which can consist of up to 32 characters.

1 Access Menu No. 560.

You can select from user phrase 1 to user phrase 20.



2 Press [ENT].

3 Store user phrase.

4 press [ENT].

Note:

- ◆ The user phrase function can only be used in the message compilation mode.
- ◆ Before a message is copied, the number of letters cannot be guaranteed. Only the number of letters available will be copied, and the remainder will be truncated.

PROGRAMMING A PACKET PATH

Select the packet path type from [New-N], [Relay], [Region], [Others1], [Others2], or [Others3].

When you press [A/B], the <USE> indicator appears on the right side of the packet path type, showing the current used information.

1 Access Menu No. 504.

[New-N]:

This digipeat type has been used mainly in North America, but is now used worldwide.

1 Select <Type> to [New-N], and press [A/B].

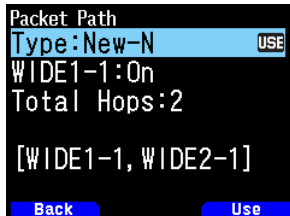

2 Select <WIDE 1-1> to [Off] or [On].

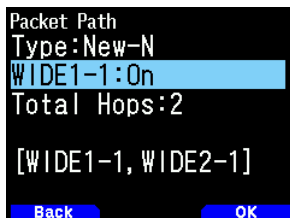

- Set <WIDE 1-1> to [On] to use the digipeater of the <RELAY type (Fill-in type) with the New-N.
- When set to [On], 1 packet path in addition to RELAY can be used, as per the <Total Hops> setting.

3 Select the relay step number for the <Total Hops> setting.

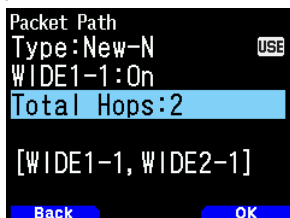

- You can confirm the setting contents in [].

[Relay]:

This is one of the digipeat types used in Europe.

1 Select the <Type> to [Relay], and press [A/B].

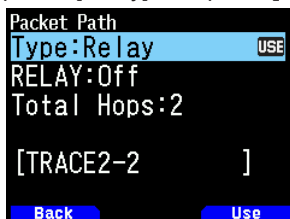

2 Select <RELAY> to [Off] or [On].

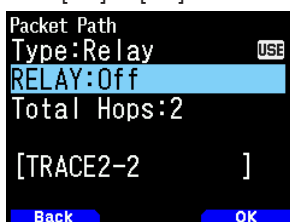

- Set <RELAY> to [On] to use the digipeater of the Fill-in type (RELAY type) with the <Relay>.
- When set to [On], 1 packet path in addition to RELAY can be used, as per the <Total Hops> setting.

3 Select the relay step number for the <Total Hops> setting.

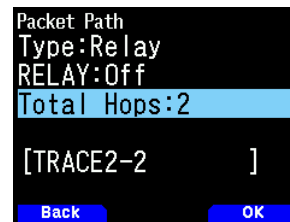

- You can confirm the setting contents in [].

[Region]:

Use this method when the packet is being relayed within only a limited area.

Packet paths are specified using ABBR (abbreviations). (In America, for example, CA represents California, AZ represents Arizona, etc.)

1 Select the <Type> to [Region], and press [A/B].

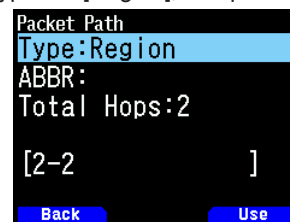

2 Using the ABBR setting, enter an abbreviation of up to 5 characters.

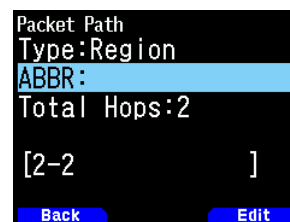

3 Select the relay step number for the <Total Hops> setting.

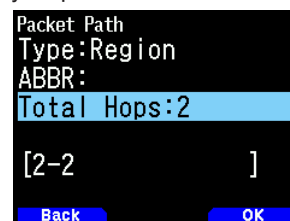

- You can confirm the setting contents in [].

[Others]:

Use this method when the relay path is specified to an individual.

When a character string is not entered, the packet data is not relayed.

1 Select the <Type> to [Others1], [Others2], or [Others3] and press [A/B].

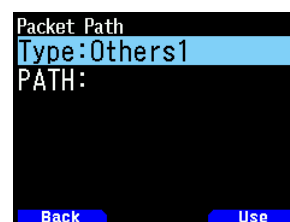

2 Enter a path.

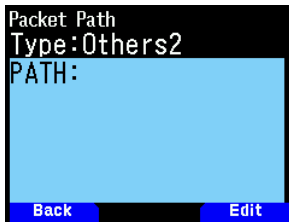

- A Packet path is the digipeat route of the packet data sent from My station.
For example, if you want your packet to take the [W4DJY-1] > [W6DJY-1] route, enter [W4DJY-1, W6DJY-1], separating each digipeater Callsign with a comma.

SETTING INTERNAL TNC

Data Speed

The default APRS packet transfer rate set on the built-in TNC is 1200 bps which is the standard among the current APRS networks.

1 Access Menu No. 505.

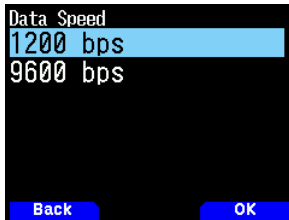

2 Select [1200] or [9600] bps.

Note:

- ◆ You can also set the Packet transfer rate to 9600 bps when necessary.

Data Band

You can select data band for APRS mode independent of the selection for Packet mode. Select band A or B as the data band for receiving or transmitting APRS packets. The default is band A. <APRS 12> or <APRS 96> indicates the current data band.

1 Access Menu No. 506.

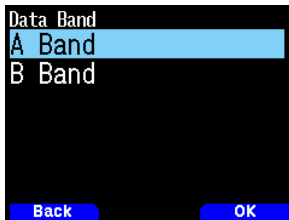

2 Select [A Band] or [B Band].

DCD Sense

You can also select the method for inhibiting the built-in TNC from transmitting.

1 Access Menu No. 507.

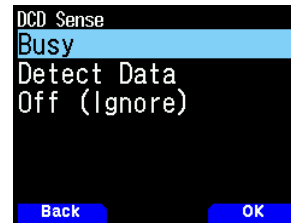

2 Select [Busy], [Detect Data], or [Off].

Inhibiting of the beacon, message, and other packet transmission is suspended while any of the following conditions is met. When the condition is no longer met, the pending data is transmitted.

[Busy]:

- ① When already in transmission state as a result of the user pressing [PTT].
- ② The data band is busy.

[Detect Data]:

- ① When already in transmission state as a result of the user pressing [PTT].
- ② When the configured packet speed (1200 bps or 9600 bps) data is detected on the data band.

[Off (Ignore)]:

- ① When already in transmission state as a result of the user pressing [PTT].

TX delay time

This function allows you to set a transmission delay time between transmitting the APRS data and transmitting a flag code prior to the APRS data.

1 Access Menu No. 508.

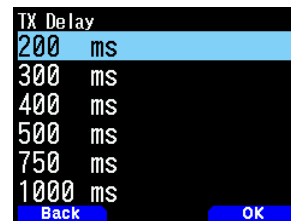

2 Select [100], [150], [200], [300], [400], [500], [750], or [1000] ms.

Note:

- ◆ Set a small value as far as possible but ensure that the local station transmitted data can be securely received at the other station. Setting a large value greater than necessary will prolong the time taken in occupying the frequency by the local station transmitted data, thus decreasing the usage efficiency of the frequency.

APRS LOCK

This function prevents accidentally changing the data band frequency or accidentally transmitting on the data band by pressing [PTT].

The [APRS lock] appears when APRS lock is activated.

- 1 Access Menu No. 509.

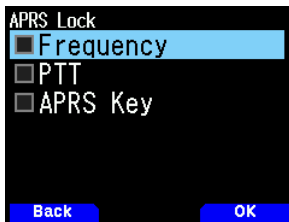

- 2 Select [Frequency], [PTT], and/or [APRS key].
- 3 Press [ENT].

Each press adds or removes a check mark.

[Frequency]: The frequency of the data band cannot be changed. (You also cannot perform Scan with [VFO], [MR], [ENT], [MHz], or the [ENC] control.)

[PTT]: The frequency of the data band cannot be changed. You cannot transmit on the data band by pressing [PTT].

[APRS key]: The frequency of the data band cannot be changed. While in APRS mode, pressing [F], [TNC] will not exit APRS mode.

- 4 Press [A/B].

SETTING TX BEACON

Beacon Transmit Method

Select the operation method for transmitting the beacon. The table concludes how operations differ depending on the selection.

- 1 Access Menu No. 510.

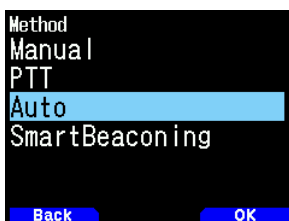

- 2 Select [Manual], [PTT], or [SmartBeaconing].

[Manual]:

Each press [BCN] transmits the beacon.

[PTT]:

- 1 Press [BCN] to switch the function ON.
 - < BCON > appears and blinks.
- 2 Press and hold [PTT], then speak into the microphone.
- 3 Release [PTT].
 - Releasing the switch transmits the beacon.
 - You cannot retransmit a beacon unless the time selected in < Initial Interval > passes. Wait until < BCON > starts blinking to indicate transmitting is ready.

- 4 To switch the function OFF, press [BCN] again.

[Auto]:

- 1 Press [BCN] to switch the function ON.
 - < BCON > appears and blinks.
 - Switching the function ON transmits the beacon once. After that, beacon is automatically transmitted at intervals of the period selected in < Initial Interval >.

- 2 To switch the function OFF, press [BCN] again.

[SmartBeaconing]:

- 1 Press [BCN] to switch the function ON.
 - < BCON > appears and blinks.
 - After manually transmitting your station position data 1 time, your position data will be automatically transmitted using the time interval set under "SmartBeaconing" (Menu No. Nos. 530 ~ 535).
- 2 To switch the function OFF, press [BCN] again.

Note:

- ◆ After setting "SmartBeaconing", the TX Interval Time, Decay Algorithm and Proportional Pathing features will no longer operate.

Initial Interval Time

You can change the interval for automatically transmitting APRS packets. The default is 1 minute.

- 1 Access Menu No. 511.

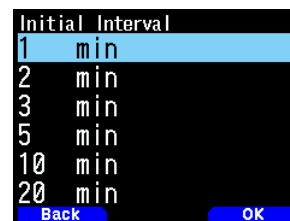

- 2 Select [0.2], [0.5], [1], [2], [3], [5], [10], [20], [30], or [60] minutes.

Note:

- ◆ With "Auto" in < Method > and Beacon ON, pressing [ENT] to complete the setting causes the APRS packet to be immediately transmitted. After that, APRS packets are transmitted at intervals of the selected period.
- ◆ While signals are present, an APRS packet is not transmitted after the interval. After signals drop, transmitting is executed.

Decay Algorithm

This function continuously extends the packet transmission interval in the case that there is no change of position information.

- 1 Access Menu No. 512.

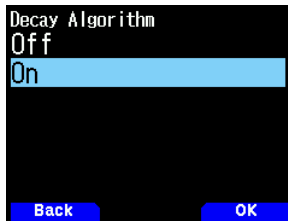

- 2 Select [On] or [Off].

- When the position data does not change, the data is transmitted based on a Decay Algorithm (ex. Interval Time = 1 minute: 2 minutes, 4 minutes, 8 minutes, 16 minutes, 32 minutes, 32 minutes, 32 minutes, etc.)
- When My station position data changes, the data is transmitted using an interval time based on the set Initial Interval.
- When the set time elapses and transmission is performed but a busy signal is present, the transceiver does not transmit. When there is no longer a busy signal, the transceiver attempts to transmit.

Note:

- ◆ While transmitting by pressing the [PTT] switch, beacon transmission is reserved.
- ◆ If My Callsign is not set, the APRS packet will not be transmitted.
- ◆ Independent of this interval, the transmission of the message is in 1 minute intervals.

Proportional Pathing

This function automatically changes the transmit packet path with the elapsed time.

- 1 Access Menu No. 513.

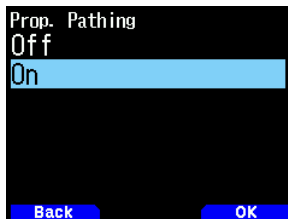

- 2 Select [On] or [Off].

Operation example for when <Proportional Pathing> = ON
Transmission interval is 2 minutes. (When the <Decay Algorithm> = ON, the decay transmission interval takes precedence.)

The packet path changes with each transmission as shown below (when the packet path is set as WIDE1-1, WIDE2-1).

2 minutes: DIRECT

4 minutes: WIDE1-1 (1 Hop)

6 minutes: DIRECT

8 minutes: WIDE1-1, WIDE2-1 (2 Hops)

10 minutes: DIRECT

12 minutes: WIDE1-1 (1 Hop)

14 minutes: DIRECT

16 minutes: WIDE1-1, WIDE2-1 (2 Hops)

This is repeated.

When jointly using a Decay Algorithm, if the speed is 1 knot or slower, a Decay Algorithm pattern is used for transmitting, but if the speed is 3 knots or faster, it changes to Proportional Pathing.

SETTING BEACON INFORMATION

Speed Information

Select whether or not to transmit speed information when using APRS data communications.

- 1 Access Menu No. 514.



- 2 Select [On] or [Off].

Altitude Information

Select whether or not to transmit altitude information when using APRS data communications.

- 1 Access Menu No. 515.

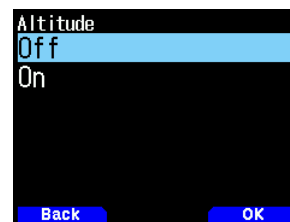

- 2 Select [On] or [Off].

- When the beacon type is [NAVITRA], this information will not appear on the display.

OBJECT FUNCTIONS

Setting the Object Information.

- 1 Access Menu No. 516.

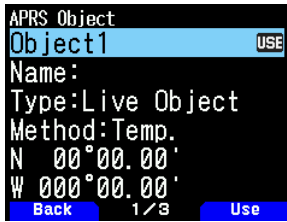

- 2 Select [Object1], [Object2], or [Object3] and press [ENT].
 - When you press [A/B], the < **USE** > indicator appears on the right side of the object item, showing the current used information.

Object Name



- 3 Enter the Object Name and press [ENT].

Transmission format type

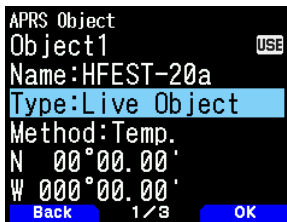

- 4 Select the type and press [A/B].
 - [Live Object]: Enabled object information
 - [Killed Object]: Disabled object information
 - [Live Item]: Enabled item information
 - [Killed Item]: Disabled item information

Note:

- ◆ The object time stamp information is embedded for the purpose of overwrite protection of information by other APRS stations, but they are not embedded time stamp information in the item. In general, the item is used, for example, notification of the temporary point not high degree of importance in comparison with the object.

Transmission interval control

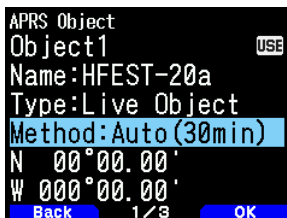

- 5 Select the Method and press [A/B].
 - [Off]: Does not send the object information.
 - [Temp.]: Send after 15 seconds, 30 seconds, 1 minute, 2 minutes, 4 minutes, 8 minutes, 16 minutes, then stop sending.
 - [Auto(15min)]: Send in 15 minute intervals
 - [Auto(30min)]: Send in 30 minute intervals

Latitude/Longitude

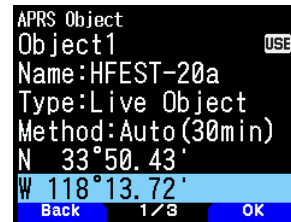

- 6 Enter a Latitude and Longitude and press [A/B].

Icon



- 7 Select the icon and press [A/B].

Comments

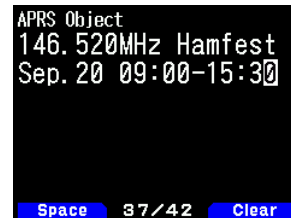

- 8 Enter the Comments and press [ENT].
- 9 Press [A/B].

Setting the Object Information

- 1 Press [F], [BCN] to send the Object Information.
 - < **OBJ** > appears on the display.
 - To stop sending the object, press [F],[BCN] again. < **OBJ** > on the display disappears.

QSY FUNCTION

The QSY function uses AFRS (Automatic Frequency Reporting System) to report a frequency on which voice communications can be established. A station using the QSY function embeds the frequency information in a position beacon transmission. A receiving station of this information can change frequency, or QSY, over to the reported voice frequency to begin voice communication by the select of [Tune].

Transmitting QSY Information

A properly configured functioning TH-D75 QSY station can automatically embed the voice frequency from the non-data band to the beginning of status text. This is the mechanism used for automatically transmitting the frequency information.

The format of the transmitted frequency is FFF.FFF MHz.

So, for example, if at the time of a beacon transmission, the non-data band has a frequency of 446.100 MHz selected, then the frequency of "446.100MHz" gets embedded to the beginning of the status text. If you configure in any of Statuses 1 through 4 the frequency of "446.100MHz" at the beginning of the status text messages, then this fixed frequency will be transmitted as QSY information along with the beacon transmission. In addition to frequencies, there are fields where you can send other settings such as Wide/Narrow, Tone/CTCSS/DCS, Shift (+/-), Offset frequency, or D-STAR operation status simply by -leaving one space between each value. Therefore, other information besides just a frequency can be sent.

QSY Information Format:

(Insert one space after the frequency before entering Wide/Narrow, Tone/CTCSS/DCS, Shift/Offset, or D-STAR operation status.)

- "T079": An upper case "T" indicates Wide. Tone frequency of 79.7 Hz. (Encoding)
- "t079": A lower case "t" indicates Narrow. Tone frequency of 79.7 Hz. (Encoding)
- "tOFF": A lower case "t" indicates Narrow. Tone = OFF (Without any tone Encoding or Decoding.)
- "C079": An upper case "C" indicates Wide. CTCSS frequency of 79.7 Hz. (Encoding/ Decoding)
- "c079": A lower case "c" indicates Narrow. CTCSS frequency of 79.7 Hz. (Encoding/ Decoding)
- "D023": An upper case "D" indicates Wide. DCS code of 023. (Encoding/ Decoding)
- "d023": A lower case "d" indicates Narrow. DCS code of 023. (Encoding/ Decoding)
- "+": Plus Shift (A default offset frequency is applied.)
- "-": Minus Shift (A default offset frequency is applied.)
- "+500": Plus Shift, 5 MHz Offset
- "-060": Minus Shift, 600 kHz Offset

The value of the Offset shall be a 3-digit number. (x 10 kHz/ 50 kHz step)

- "D-STAR": D-STAR simplex (DV) mode
- "D-STAR>W6DJY B": D-STAR Repeater (DR) mode (monitoring "W6DJY B" as the access repeater)

Note:

- ◆ Refer to the website for QSY Information Format:
<http://aprs.org/info/freqspec.txt>

QSY Information Transmission Operation

This function embeds the voice channel frequency, Wide/Narrow status, tone, shift, and offset information in the first character of the status text.

- 1 Access Menu No. 520.

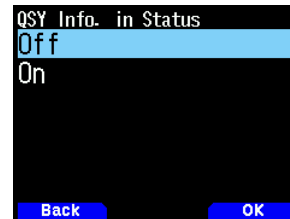

- 2 Select [On].

Set to [On] to embed the frequency information at the beginning of the status text. When the voice channel (non-data band) is in DR mode, the configured access repeater information will also be embedded.

- 3 Access Menu No. 521.



- 4 Select [On] or [Off].

Set to [On] to embed the frequency, then followed by the tone/FM narrow information in the status text.

- 5 Access Menu No. 522.



- 6 Select [On] or [Off].

Set to [On] to embed the frequency information, tone/FM narrow information, followed by the shift direction and offset width information in the status text.

QSY Limit Distance

This function is for tuning in to only data within a specified distance range from your own station and setting a QSY information such as frequency for a non-data band in APRS data communication.

- 1 Access Menu No. 523.

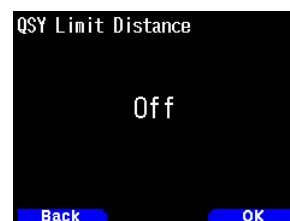

- 2 Select [Off], [10], [20] ... [2490], or [2500]. (The unit selected in Menu No. 970 (Speed, Distance) is used.)

Operation When Receiving a QSY

When QSY (frequency) information is received, the station list appears with the verified frequency.

- 1 Select [Tune], and press [A/B].

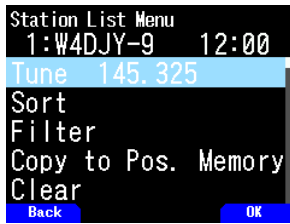

- The frequency is set in the voice channel (non-data band).

Note:

- ◆ When using 6.5 kHz or 12.5 kHz step values, the display does not indicate values for 100 Hz and lower.
- ◆ If D-STAR repeater information is included in the QSY information of the received beacons and when the voice channel (non-data band) is in DR mode, the QSY function will be activated even outside the range of distance limit. Gateway communication will be configured automatically.

SETTING SmartBeaconing™

Set to use "SmartBeaconing" (Menu No. 510) with APRS data transmission.

This function optimizes beacon transmission based on driving direction and speed. Use this function when you want to track your transmissions, especially for optimizing crossover beacon transmission intervals.

When using smart beaconing, set Menu No. 571 (TX Beep) to [On] (default value) to confirm the transmission status of the beacon.

< SmartBeaconing™ from HamHUD Nichetronix >

Low Speed/ High Speed

- 1 Access Menu No. 530.

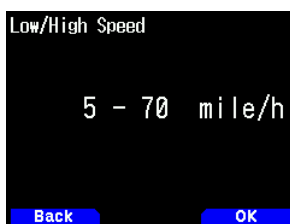

- 2 Select the Low speed and High speed.
 - Low speed setting (2 ~ 30 <mi/h, km/h or knots>). When the speed is lower than this, beacons are transmitted at the time interval specified under "Slow Rate".
 - High speed setting (2 ~ 90 <mi/h, km/h or knots>). When the speed is faster than this, beacons are transmitted at the time interval specified under "Fast Rate".

Note:

- ◆ To select the speed setting of the units, access Menu No. 970 (Speed, Distance).

Slow Rate

Low speed transmission interval time.

- 1 Access Menu No. 531.

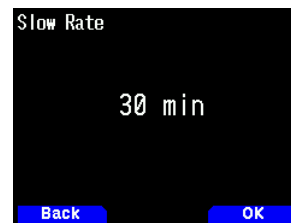

- 2 Select from [1] to [100] minutes.

Fast Rate

High speed transmission interval time .

- 1 Access Menu No. 532.

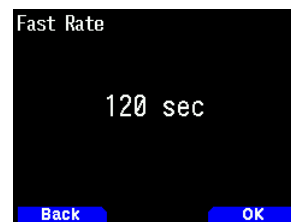

- 2 Select from [10] to [180] seconds.

Turn Angle

Driving direction change, minimum value setting.

- 1 Access Menu No. 533.



- 2 Select from [5] to [90] degrees.

Turn Slope

Driving direction change, additional value setting.

- 1 Access Menu No. 534.



- 2 Select from [1] to [255] (10degrees/speed).

Turn time

Minimum time delay between each beacon transmission by change of direction.

- 1 Access Menu No. 535.



- 2 Select from [5] to [180] seconds.

Note:

- ◆ Adjust the Setting values to match the actual driving status.

SmartBeaconing Operation:

Speed	Transmission Interval	Corner Pegging
Above the <High Speed>	<Fast Rate>	Operates normally
Under <High Speed> Over <Low Speed> (Only when the set <High Speed> ≥ <Low Speed>)	The interval is calculated using the following formula: (Transmission Interval = <Fast Rate> x <High Speed> ÷ Speed)	Operates normally
Below the <Low Speed>	<Slow Rate>	Will not operate

Transmission Interval Example:

(with <Low Speed> = 5, <High Speed> = 70, <Slow Rate> = 30 min, <Fast Rate> = 120 sec)

Speed	Interval
80	120 seconds (2 minutes)
70	120 seconds (2 minutes)
50	168 seconds (2 minutes 48 seconds)
30	280 seconds (4 minutes 40 seconds)
20	420 seconds (7 minutes)
10	840 seconds (14 minutes)
5	1680 seconds (28 minutes)
0	1800 seconds (30 minutes)

Corner Pegging Operation Example:

(with <Turn Angle> = 30° <Turn Slope> = 24)

Speed	<Turn Slope>	<Turn Slope> ÷ Speed (1)	<Turn Angle> (2)	Turn Threshold (3)=(1)+(2)
60	24 (x10)	4°	30°	34°
50	24 (x10)	6°	30°	36°
30	24 (x10)	8°	30°	38°
20	24 (x10)	12°	30°	42°
10	24 (x10)	24°	30°	54°
5	24 (x10)	48°	30°	78°

- When the value of "Turn Threshold" exceeds 120°, it is calculated as 120°.

SETTING WAY POINT

A waypoint refers to a point that is registered in external devices with a name being assigned to specific position coordinates.

By outputting the Callsigns of other stations received by the transceiver and the position data as waypoint data, these information can be displayed on GPS receivers with display screen and tablet screens where APRS application is installed.

Way Point Format

Select the type of Way point Format that is sent.

- 1 Access Menu No. 540.

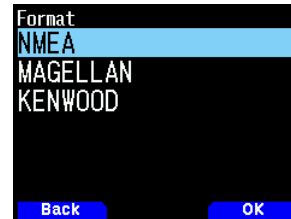

- 2 Select [NMEA], [MAGELLAN] or [KENWOOD].

[NMEA]: The data using the NMEA 0183 "\$GPWPL" format.

[MAGELLAN]: The data using the "\$PMGNWPL" format.

[KENWOOD]: The data using the "\$PKWDWPL" format.

Way Point Length

Select the length of the Way Point Name.

- 1 Access Menu No. 541.



- 2 Select [6-Char], [7-Char], [8-Char], or [9-Char]

Way Point Output

Select the Way Point output type.

- 1 Access Menu No. 542.



- 2 Select [All], [Local], or [Filtered]

[All]: All Way point information is sent.

[Local]: If the position limit is ON, all the data within the position limit is sent. If the position limit is OFF, all Way point data is sent.

[Filtered]: Information that is permitted using the packet filter is output as Way point information.

SETTING PACKET FILTER

Position Limit

If APRS is popular in your area, you may receive too many APRS packets for a short period. If this disturbs your APRS activities, specify a distance from your location. You will not receive APRS packets from stations beyond this distance.

Select the range from 10 to 2500 in steps of 10, plus OFF (default). The unit is mile or kilometer depending on the selection in Menu No. 970.

- 1 Access Menu No. 550.

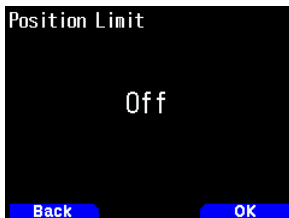

- 2 Select [Off], [10], [20] ... [2490], or [2500]. (The unit selected in Menu No. 970 (Speed, Distance) is used.)

Packet Filter Type

- 1 Access Menu No. 551.



- 2 Select [Weather], [Digipeater], [Mobile], [Object], [NAVITRA], [1-WAY], and/or [Others].
- 3 Press [ENT].
Each press adds or removes a check mark.
The APRS position data is filtered.
 - Check the type(s) you want to receive.
 - If all types are checked, you will receive all types of data.

STORING USER PHRASES

This function (clipboard image) allows you to paste phrases into the APRS message compilation mode. You can create up to 20 phrases each of which can consist of up to 32 characters.

- 1 Access Menu No. 560.



- 2 Select the message number.
- 3 Press [A/B].
- 4 Enter the phrases.
 - The user phrase function can only be used in the message compilation mode.
 - Before a message is copied, the number of letters cannot be guaranteed. Only the number of letters available will be copied, the remainder will be truncated.
 - To copy a message, enter message compilation mode, press [F] to enter function mode, then press [1] (Paste 1), [2] (Paste 2), [3] (Paste 3), [4] (Paste 4), [5] (Paste 5), [6] (Paste 6), [7] (Paste 7), [8] (Paste 8) or [9] (Paste 9) key for 1 second to copy the message that has been set up for each key.
 - If the user messages are not set up, they cannot be used.

STORING AUTO MESSAGE REPLY

While you are driving, for example, you cannot immediately answer to received messages. On this transceiver, you can program the message to be automatically returned when a message is received.

Auto Reply

- 1 Access Menu No. 561.

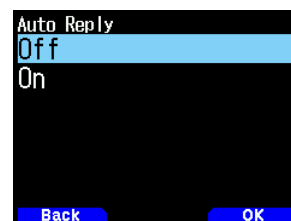

- 2 Select [On] or [Off].
 - "AA:", meaning "Auto Answer message", is automatically added to the beginning of all auto-reply messages. This has been added, based on the recommendations of "APRS SPEC Addendum 1.1". Refer to <http://aprs.org/aprs11.html> for details.

Reply To Callsign

When there is a message you would like to reply to for the specific Callsign, preset that Callsign for automatic responses.

- 1 Access Menu No. 562.



- 2 Enter the Callsign.
 - A reply will be sent to all matching stations when using the wildcard mark (*).
For example, if you enter JA1*, a response is sent to all Callsigns beginning with JA1.

Reply Delay Time

After a message has been received, if you operate the transceiver during the delay time, before the message is sent, the auto-reply message is canceled. You can set the wait time as 0, 10, 20, 30, or 60 seconds. The default setting is 10 seconds.

- 1 Access Menu No. 563.

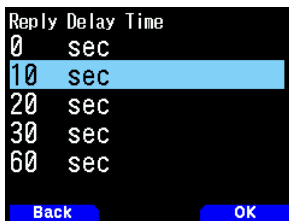

- 2 Select [0], [10], [20], [30], or [60] seconds.
 - When a message is received before the delay time has completed counting down, the timer will reset and begin counting down again.
 - When multiple messages are received from the same caller before the delay time has completed counting down, only one message will be sent through auto-reply message.
 - When the delay time is set to 0 seconds, auto-reply message will send a response immediately following an acknowledged received message.

Reply Message Text

- 1 Access Menu No. 564.



- 2 Enter the message text.
 - The display for entering a message appears; the first digit blinks.
 - You can enter alphanumeric characters plus special ASCII characters.

SETTING NOTIFICATION SOUND

RX Beep Type

This transceiver beeps each time it receives any type of APRS packets.

- 1 Access Menu No. 570.



- 2 Select [Off], [Message Only], [Mine], [All New], or [All].
 - [Off]:** The APRS beep tone does not sound.
 - [Message Only]:** Beep sounds only when a message is received at your station address.
 - [Mine]:** Beep sounds when a message is received at your station address and your transmitted data is received by a digipeater.
 - [All New]:** Beep sounds when a message is received at your station address and new packet data is received.
 - [All]:** Beep sounds when a message is received at your station address and duplicate data or invalid data is received.

TX Beep

When your beacon is transmitted in a manner other than manually, you can select whether or not it emits a beep sound.

- 1 Access Menu No. 571.



- 2 Select [Off] or [On].
 - [Off]:** A beep does not sound.
 - [On]:** A beep sounds when a beacon is transmitted using [PTT] or when it is automatically transmitted. When auto-reply message sends a response, a beep will sound.

Special Call

This function emits a special call sound when receiving an APRS message from a specific station.

- 1 Access Menu No. 572.



- 2 Set the Callsign (including SSID) of the station from which you want to receive a special call notification.

SETTING DISPLAY

Display Area

Selects the Display area.

- 1 Access Menu No. 573.

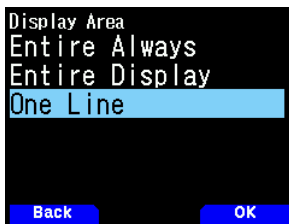

- 2 Select [Entire Always], [Entire Display] or [One Line].

[Entire Always]: The received new data, duplicate data, and My station data information appears on the full display, other data information appears only at the top of the display.

[Entire Display]: The received new data information appears on the full display, other data information appears only at the top of the display.

[One Line]: The received new data information appears only at the top of the display

Note:

- ◆ When an emergency message or a message designated for your station is received, the received data information appears on the full display, even if the display method is set to [One Line].

Interrupt Time

Set the duration to display an indication for when new data is received. If you select [Infinite], the indication cannot be canceled.

- 1 Access Menu No. 574.



- 2 Select [5], [10], [20], [30], [60] seconds or [Infinite].

APRS VOICE

This function is to announce the Callsign and information of the transmission source when an APRS signal is received.

- 1 Access Menu No. 575.

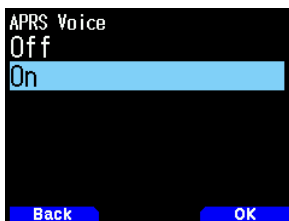

- 2 Select [Off] or [On].

[Off]: Turn off the APRS Voice function.

[On]: Turn on the APRS Voice function.

Note:

- ◆ The APRS Voice (menu No. 575) operates regardless of the Voice Guidance mode setting (menu No. 916).

SETTING DIGIPEATER

The transceiver works as a standalone digipeater.

Digipeat (My Call)

Sets whether to run Digipeat (MyCall) when the transceiver is used as a digipeater.

If the receiver packet path contains My Callsign (set in Menu No.500), the digipeat completion flag (*) is added to My Callsign and the packet is digipeated.

(e.g., "W4DJY-1" > "W4DJY-1*")

- 1 Access Menu No. 580.



- 2 Select [Off] or [On].

[Off]: Turns OFF the Digipeat (MyCall) function.

[On]: Activates the Digipeat (MyCall) function.

Ulcheck

This function will not digipeat a one-time received UI frame within the set Ulcheck time. This applies to any of Uldigipeat, Ulflood, and Ultrace.

- 1 Access Menu No. 581.

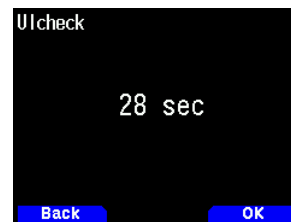

- 2 Select from [0], [1], [2] to [250] seconds.

Note:

- ◆ The UI frame (Unnumbered Information frame) is used in APRS to exchange data without establishing a connection. Uldigipeat, Ulflood and Ultrace are all specialized UI frame forwarding methods.

Uldigipeat

Sets whether to run UI digipeat when the transceiver is used as a digipeater.

If the received UI frame contains one of the entered aliases (e.g., "WIDE1-1" for one-hop fill-in digi) of the beginning part of the packet path that has not yet been digipeated, the alias is replaced to My Callsign with the digipeat completion flag (*), and digipeated.

(e.g., WIDE1-1, WIDE2-1 > W4DJY-1*, WIDE2-1)

- 1 Access Menu No. 582.



- 2 Select [On] or [Off].

[Off]:

Turns OFF UI digipeater function.

[On]:

Activates UI digipeater function.

Uldigi Aliases

Sets the characters to use as aliases for UI digipeat.

- 1 Access Menu No. 583.

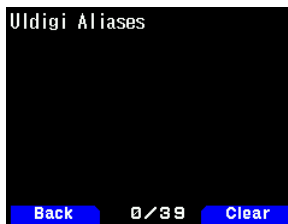

- 2 The characters that can be entered are the alphabetic characters "A" to "Z", [0] to [9], "-".

Note:

- ◆ If [ENT] is pressed while a space is being inserted using the Insert function, the setting will not be confirmed and an error will occur.
- ◆ When no alias is set (default), My Callsign is applied and the digipeat completion flag is added.
- ◆ An alias can be a string of up to 9 characters x 4 separated by commas.
- ◆ When My Callsign is already digipeated, or if the SSID is different, the packet is not digipeated.
- ◆ When Uldigipeat is set to "Off", even if Uldigipeat aliases are set, the packet is not digipeated.
- ◆ Each Digipeat(MyCall), Uldigipeat, Ulflood, Ultrace can operate independently.

Ulflood

Sets whether to run Ulflood digipeat when the transceiver is used as a digipeater.

If the received UI frame contains the entered alias (e.g., "CA" for California), the number of hops (e.g., 3-3) is decremented by 1 and digipeated.

(e.g., "CA3-3" > "CA3-2")

- 1 Access Menu No. 584.



- 2 Select [On] or [Off].

[Off]:

Turns OFF Ulflood digipeat function.

[On]:

Activates Ulflood digipeat function.

Ulflood Alias

Sets the characters to use as an alias for Ulflood digipeat.

- 1 Access Menu No. 585.



- 2 The characters that can be entered are the alphabetic characters "A" to "Z" and [0] to [9].

Note:

- ◆ If [ENT] is pressed while a space is being inserted using the Insert function, the setting will not be confirmed and an error will occur.
- ◆ When Ulflood is set to "Off", even if Ulflood alias is set, the packet is not digipeated.

Ulflood Substitution

Select the callsign substitution method to use when running Ulflood digipeat.

- 1 Access Menu No. 586.



- 2 Set [First], [ID], or [NOID].

[First]:

When there is no callsign in the digipeated UI frame, My Callsign is embedded. When there is already a callsign in the digipeated UI frame, the callsign is not embedded or replaced.

[ID]:

My Callsign is embedded. When there is already a callsign in the digipeated UI frame, My Callsign will replace the existing callsign.

[NOID]:

The callsign is not embedded or replaced.

Ultrace

Sets whether to run Ultrace digipeat when the transceiver is used as a digipeater.

If the received UI frame contains the entered alias (e.g., WIDE), the number of hops (e.g., 2-2) is decremented by 1, My Callsign is added to the UI frame, and digipeated.

(e.g., "WIDE2-2" > "W4DJY-1 ✖, WIDE2-1")

- 1 Access Menu No. 587.

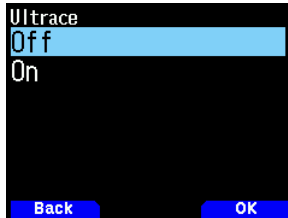

- 2 Select [On] or [Off].

[Off]:

Turns OFF Ultrace digipeat function

[On]:

Activates Ultrace digipeat function.

Ultrace Alias

Sets the characters to use as an alias for Ultrace digipeat.

- 1 Access Menu No. 588.



- 2 The characters that can be entered are the alphabetic characters "A" to "Z", [0] to [9], ",", "-", ".".

Note:

- ◆ If [ENT] is pressed while a space is being inserted using the Insert function, the setting will not be confirmed and an error will occur.
- ◆ When Ultrace is set to "Off", even if Ultrace aliasing is set, the packet is not digipeated.
- ◆ Each Digipeat (MyCall), Uldigipeat, Ulfood, Ultrace can operate independently.
- ◆ If you erase all characters, the default "TEMP" is automatically set.

PC OUTPUT

This function outputs data from the USB port/ Bluetooth after receiving packet or waypoint data from the APRS data communications. Use this function to verify the received data from the transceiver.

- 1 Access Menu No. 590.

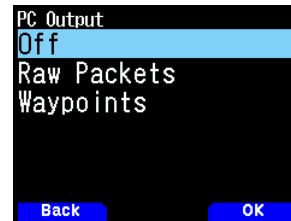

- 2 Select [Raw Packets] or [Waypoints].

[Raw Packets]: Outputs raw packets data.

[Waypoints]: Outputs way point format data.

Note:

- ◆ In APRS, only packet I-frames (information frames) received from the transceiver will be output. C-connect request, D-disconnect request, UA-acknowledgement, and UI-unconnected information frames will not be output.

NETWORK

Set APRS data communications UNPROTOCOL. UNPROTOCOL is the method in which packet data is transmitted without other stations or making a connection.

Select either [APRS(APK005)] or [Altnet].

When you press [A/B], the < USE > indicator appears on the right side of the network type, showing the current used information.

- 1 Access Menu No. 591.

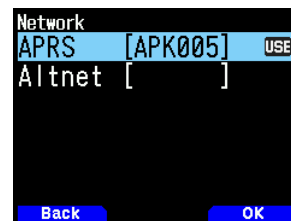

- 2 Select [APRS] or [Altnet].

[APRS]: (Use this setting for normal use: default setting)

When transmitting messages and meteorological data using the TH-D75, "APK005" is added to the packet, following your station Callsign.

There are no restrictions on received packets.

[Altnet]: When it is necessary to add restrictions to received packets, you can set it for special use.

Select [Altnet] and press [ENT], then enter your desired character string.

When transmitting messages and meteorological data using the TH-D75, the character string you entered is added to the packet, following your station Callsign.

VOICE ALERT

This function will notify another station as to whether or not they are within communications range by emitting beacon tones.

When a Mobile Station is mobile with the Voice Alert function turned ON, other stations also with Voice Alert turned ON will hear the beacon sound of the Mobile Station if they have matching tone (CTCSS) frequencies and are within range, thus informing the stations that communications is possible.

Setting Voice Alert

- 1 Access Menu No. 592.

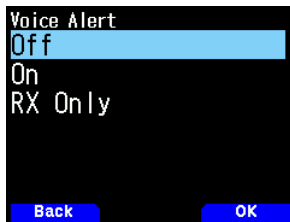

- 2 Select [Off], [On] or [RX Only]. informing the stations that communications is possible.

[Off]: Voice Alert is disabled.

[On]: A tone frequency is added to the transmitted packet. < VA > indicator appears above the displayed frequency.

[RX Only]: A tone frequency is not added to the transmitted packet. < VAR > indicator appears above the displayed frequency.

Note:

- ◆ Voice alert takes precedence even when TONE, CTCSS and DCS are set.
- ◆ When Voice alert is ON, you cannot perform TONE or CTCSS frequency selection and DCS code selection.
- ◆ When the data speed is 9600 bps, the TONE, CTCSS, DCS will disrupt the demodulation of the packet. Set the packet speed to 1200 bps when using Voice Alert.

Voice Alert Frequency

- 1 Access Menu No. 593.

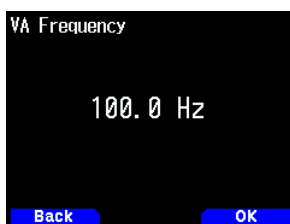

- 2 Select the tone (CTCSS) frequency.

PROGRAMMING MESSAGE GROUP CODE

Message Group Code

Use a message group code to exchange messages only among your group members. With one or more message group codes programmed, you will receive messages that include the same group code(s), besides messages addressed to you.

- 1 Access Menu No. 594.



- 2 Enter the message group code.

You can also program up to 6 codes at the same time; each code must be separated by a comma (,). If you program 3 message group codes, for example, you will receive all messages that include one of the 3 codes. If you program 3 bulletin group codes, you will reject bulletins addressed to specific groups which do not use any of the 3 codes.

- You can enter 0 to 9, A to Z, , (comma), and -. For messages, < * > is also selectable.
- The keypad on the microphone also is available to enter alphanumeric characters.

Bulletin Group Code

If you program one or more bulletin group codes, you will not receive bulletins addressed to other specific groups. You can program any desired code using alphanumeric characters; up to 5 characters for bulletins (up to 6 group).

- 1 Access Menu No. 595.



- 2 Enter the bulletin group codes.

- You can enter 0 to 9, A to Z, , (comma), and -.

15 BUILT-IN KISS TNC

The built-in TNC operates in KISS (Keep It Simple, Stupid) mode.

When connecting the transceiver to a PC installed with APRS software and operating the IGate and Digipeater stations, set the transceiver to KISS mode.

KISS MODE OPERATION

Press [F], [LIST] to enter KISS mode.



The following indicators appear on the transceiver display to show the current TNC status:

Indicator	Status
KISS	The TNC is in KISS mode.
12	1200 bps packet transfer rate selected.
96	9600 bps packet transfer rate selected.
STA	Packets to be transmitted still remain in the buffer.

Note:

- ◆ The built-in TNC does not support Command mode or Converse mode.
- ◆ The built-in TNC has 4k byte KISS mode data buffers for TX and RX.

Setting the Data Band Frequency

Set the data band frequency to the KISS network frequency. The default setting of the data band is band A.

You can change the data band to band B by Menu No. 506.

Selecting the USB/ Bluetooth

You can select the device to USB or Bluetooth by Menu No. 983.

- When connecting to a computer using a USB cable, download the virtual COM port driver.
- Download the virtual COM port driver from the URL listed below.

https://www.kenwood.com/i/products/info/amateur/software_download.html

Note:

- ◆ Do not connect the transceiver to a PC with a USB cable until the installation of the virtual COM port driver downloaded from the above URL has been completed. If the transceiver is connected to a PC without installing the virtual COM port driver, a wrong driver incompatible to the transceiver may be installed and communication between the transceiver and PC may not be established. To prevent the installation of a wrong driver, be sure to complete the installation of the virtual COM port driver before connecting to a PC.
- ◆ Transfer rate (baud rate) between the transceiver and PC are USB (up to 12 Mbps) or Bluetooth (up to 128 Kbps).
- ◆ Depending on the usage condition of the apparatus, saved content may be lost. JVCKENWOOD does not take responsibility for damages or lost content.

Supported Command List

The built-in KISS TNC supports the following KISS standard commands.

Command (Hexadecimal)	Command Name	Description	Parameter	Default (When KISS mode is ON)
00	Data Frame	This frame contains data that should be sent out of the TNC.	–	–
01	TXDELAY	Setting the amount of time to wait between keying the transmitter and beginning to send data (in 10 ms units).	0 to 120(78h)	By setting the menu No.508 (TX Delay).
02	P	Setting the persistence parameter. Used for CSMA.	0 to 255(FFh)	128(80h)
03	SlotTime	Setting the slot time (in 10 ms units). Used for CSMA.	0 to 250(FAh)	10(0Ah)
04	TXtail	Setting the length of time to keep the transmitter keyed after sending the data (in 10 ms units).	0 to 255(FFh)	3
05	FullDuplex	Setting the half duplex or full duplex.	0: Half duplex other ten 0: Full duplex	0
06	SetHardware	Switching the packet communication speed.	0 or 35(23h) : 1200bps 5(05h) or 38(26h): 9600bps"	By setting the menu No.505 (Data Speed).
FF	Return	Exit KISS mode.	–	–

Note:

- ◆ As the built-in TNC directly enters KISS mode and not via command mode, commands such as "KISS ON" and "RESTART" to enter KISS mode from command mode are not necessary in the APRS software.
- ◆ After exiting KISS mode with the KISS command "C0,FF,C0" (192,255,192) and when KISS mode is set to ON again with a command from the PC, use the PC command "TN 2,0"(Data Band:A Band) or "TN 2,1"(Data Band:B Band) .

D-STAR INTRODUCTION

- In the original D-STAR (Digital Smart Technologies for Amateur Radio) plan, JARL envisioned a system of repeaters grouped together into Zones.
- The D-STAR repeater enables you to call a D-STAR station in another area through the Internet.
- The transceiver can be operated in the digital voice mode, including low-speed data operation, for both transmit and receive.

Note:

- ◆ Before starting D-STAR, the following steps are needed.
 - STEP 1:** Enter your Callsign in the transceiver.
 - STEP 2:** Register your Callsign to a gateway repeater. Refer to the User Guide in detail.

DV MODE/ DR (D-STAR REPEATER) MODE

DV (Digital Voice) mode is a mode you can use for direct call without using a repeater.

DR (D-STAR Repeater) mode is a mode you can use for D-STAR repeater operation. In this mode, you can select the preprogrammed repeater or frequency in "FROM" (access repeater), and UR Callsign in "TO" (destination), as shown below.

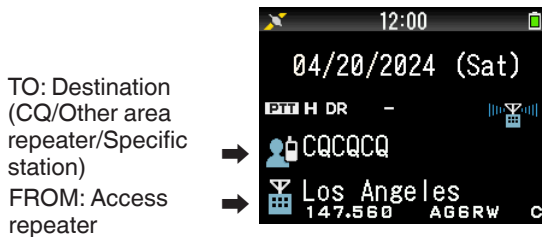

DR mode (Main band)

Communication in DR Mode

In the DR mode, the transceiver has 3 communication ways.

Local area call

To call through your local area (access) repeater.

Gateway call

To call through your local area (access) repeater, repeater gateway and the Internet to your destination repeater or individual station's last used repeater, using Callsign routing.

Call by Callsign designation

To call by designating the Callsign of the specific station. This call is relayed automatically to the last accessed repeater.

Basic operations in DR mode

- **Press and hold [▲] to set "TO" (destination).**
You can set "TO" in Local area call, Gateway call, and Call by Callsign designation, etc.
- **Press and hold [ENT] to set "TO" (destination) by Call History.**
You can recall in Gateway call, etc.
- **Press and hold [▼] to set "FROM" (access repeater).**
You can select "FROM" (access repeater) in Local area call and Gateway call.
- **Press and hold [▶] to display RX History.**

Note:

- ◆ The basic operations in DR mode are not supported in DV mode.
- ◆ The transceiver has a Time-Out Timer function for digital repeater operation. The timer limits a continuous transmission to approximately 10 minutes.

MY CALLSIGN

Set your Callsign to the transceiver in DV/DR mode. Transmission in DV/DR mode will not be possible if you do not set your Callsign.

Up to 6 Callsigns can be registered. For your Callsign, you can register a Callsign that is within 8 characters and any memo (name or rig name, mobile operation destination, etc.) that is within 4 characters after a slash (/).

- 1 Access Menu No. 610.
- 2 Select a number for registration and press [A/B].
- 3 Input your Callsign.
 - For the character input procedure, refer to page No.6-1.

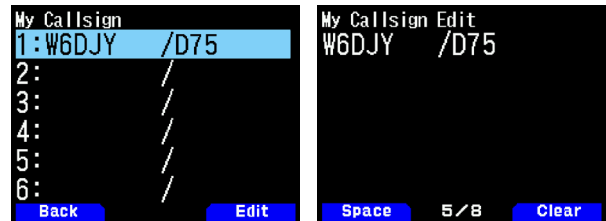

- 4 Press [ENT].
Your Callsign is set.

Note:

- ◆ The Callsign that can be registered is the one shown on your certificate. A nickname or the like cannot be registered.

DIGITAL FUNCTION MENU

This menu switches the functions to use for operation in digital mode.

How to Use the Digital Function Menu

- 1 Press **[MODE]** to enter DR mode.
- 2 Press **[F]**, **[MODE]**.
The Digital Function Menu appears.

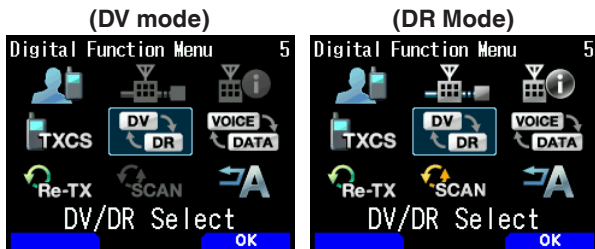

- 3 Select an item in the Digital Function Menu and press **[A/B]**.
The setting menu for the selected item appears. For the detailed setting procedures, refer to the pages for each function.

Note:

- ◆ If you select **[DV/DR Select]** or **[Data Mode]**, the setting is changed and return to the previous screen.

The following table shows the items in the Digital Function Menu in DV mode and DR mode.

The items are different in DV mode and DR mode.

DR mode	DV mode
1 Destination Select	1 Destination Select
2 Route Select	
3 Repeater Detail	
4 CS Setting	4 CS Setting
5 DV/DR Select	5 DV/DR Select
6 Data Mode	6 Data Mode
7 TX History	7 TX History
8 DR Scan	
9 Auto Reply	9 Auto Reply

SIMPLEX CALL

Simplex call can be used for direct communication between a pair of transceivers without using a repeater. Simplex call can be operated only in DV mode.



Example: Outputting CQ at 446.100 MHz

- 1 Set the frequency to 446.100 MHz with **[▲]/[▼]** or **[ENC]** control.
- 2 Press **[MODE]** to enter DR mode.
When the mode is already DV mode, move to step 4.
- 3 Switch to DV mode in the Digital Function Menu.
- 4 Select **[Destination Select]** in the Digital Function Menu.
The destination selection screen appears.
- 5 Select **[Local CQ]** and press **[ENT]**.
[CQCQCQ] is set to **[TO]**.
- 6 Press **[PTT]** to transmit.

Note:

- ◆ Receive at the frequency at which you will attempt to transmit and check that there will be no interference with other stations.
- ◆ When you set DV mode for the first time, **[CQCQCQ]** is set to **[TO]**.
- ◆ Simplex call in digital mode can be operated only in DV mode.

LOCAL AREA CALL

A local area call (local CQ) is the output of a CQ through only one repeater. A call can be made by setting a local CQ to "TO" and pressing [PTT].

Setting the Access Repeater (FROM)

- 1 Press [MODE] to enter DR mode.
- 2 Press and hold [▼].
The FROM selection screen appears.
- 3 Select [Repeater List] and press [ENT].
The World Region, Country & Region, and group select screen appears.
- 4 Select your area group and press [ENT].
The repeater list selection screen appears.
- 5 Select a nearby repeater from the repeater names or state/prefecture names and press [ENT].
The access repeater is set to [FROM].

Setting the Local CQ (TO)

- 1 Press and hold [▲].
The destination selection screen appears. This screen also appears when selecting [Destination Select] in the Digital Function Menu.
- 2 Select [Local CQ] and press [ENT].
CQCQCQ is set to [TO].

Checking Whether Signals Reach the Repeater

- 1 Press and hold [PTT] and transmit.
- 2 Check the response.
If < 📶🟢 > appears within 3 seconds, this indicates that signals are reaching the repeater you are using and signals are being output normally from the destination repeater. However, < 📶🟢 > does not appear if there is an access from another station within 3 seconds. (Refer to the table below.)

Transmitting

Press [PTT] to transmit.

Phenomenon	Cause	Treatment
No message is returned from the access repeater after transmission. (S-meter indicator also does not move.)	In case that the selection for the repeater you are using (access repeater) is incorrect.	Set the correct access repeater to [FROM].
	In case that the repeater frequency is incorrect (or the shift direction or offset width settings are incorrect).	Set the repeater frequency (or the shift direction or offset width settings) correctly.
	In case that it is out of the repeater area (or the signal does not reach the repeater).	Move to a location where the signal reaches the repeater or access another repeater that the signal will reach.
The access repeater Callsign and < 📶🔴 > appear after transmission.	In case that your Callsign is not registered to the D-STAR management server or the registered information is different.	Register your Callsign to the D-STAR management server or check the registered information.
	In case that the other station's Callsign is not registered to the D-STAR management server or the registered information is different.	Check the registration status of the other station's Callsign on the D-STAR management server (only when the other station is open in public.)
The destination repeater Callsign and < 📶🔴 > appear after transmission.	In case that a destination repeater can not be reached or the destination repeater is in use.	Wait a while and call again.

GATEWAY CALL

A gateway call can be made by setting the area repeater to output the CQ to [TO] and pressing [PTT].

A gateway CQ is the output of a CQ to an area that is different from that of your station through a repeater connected to the Internet. A call can also be made to an area signals cannot directly reach because of the connection to the Internet.

Setting the Access Repeater (FROM)

Set a nearby repeater to [FROM].

Setting the Destination Repeater (TO)

- 1 Press and hold [▲].
The destination selection screen appears. This screen also appears when selecting [Destination Select] in the Digital Function Menu.
- 2 Select [Gateway CQ] and press [ENT].
The World Region, Country & Reigion, and group select screen appears.
- 3 Select your area group and press [ENT].
The repeater list selection screen appears.
- 4 Select the destination repeater.
Press [▶] to display detailed information of the repeater that you selected. When you press [ENT], the repeater is set to [TO].

Checking Whether Signals Reach the Repeater (TO)

- 1 Press and hold [PTT] and transmit.
- 2 Check the response.
If < 📶 > appears within 3 seconds, this indicates that signals are reaching the destination repeater through the Internet and signals are being output normally from the destination repeater. However, < 📶 > does not appear if there is an access from another station within 3 seconds.

Transmitting

Press [PTT] to transmit.

REPLY TO THE GATEWAY CALL

When you reply to a Gateway CQ or a Gateway Individual call, you need to set the destination Callsign to [TO] before pressing [PTT].

- 1 Press and hold [ENT] after the transmission by the caller station is finished.
- 2 Select the Callsign of the caller station by Call History, and press [ENT] to capture the Callsign.
The Callsign is set to [TO], and the route setting for Gateway Call is also automatically set.

Note:

- ◆ Due to the D-STAR structure, you can not make a reply to the Gateway Call in the setting by [Local CQ].
- ◆ The Callsign of the other station is stored in Call History when the transmission by the other station is finished. Press and hold [ENT] after the transmission by the other station is finished.
- ◆ In stable communication condition, you can also make a reply by Direct Reply function without manually setting the destination Callsign.

CALLSIGN DESIGNATION

A call by Callsign designation can be made by setting the Callsign of the other party to [TO] and pressing PTT. A call to the specific station is relayed automatically to the last accessed repeater, so a call can be made without knowing the area in which the other station is currently located.

Setting the Access Repeater (FROM)

Set a nearby repeater to [FROM].

Setting the Destination (TO)

- 1 Press and hold [▲].
The destination selection screen appears. This screen also appears when selecting [Destination Select] in the Digital Function Menu.
- 2 Select [Individual] and press [ENT].
The Callsign list appears.
- 3 Select the Callsign and press [ENT].
The individual Callsign and name are set to [TO].
- 4 Press [PTT] to transmit.

CALLSIGN LIST

Up to 300 Callsigns of the other stations can be registered. Names and any memo can also be registered instead of Callsigns. The registered names are displayed in the TX History and RX History.

Editing the Callsign

You can edit the information of the Callsign.

- 1 Access Menu No. 220.
The Callsign list selection screen appears.

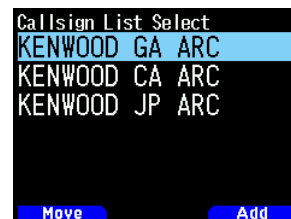

- 2 Press [A/B].
The Callsign list editing screen appears.

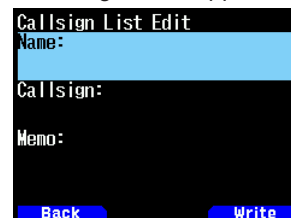

- 3 Select the item and press [ENT].
The editing screen for the selected item appears. You can register or edit the name, Callsign, and memo, etc.
- 4 Press [ENT] after editing.
Editing are completed and the Callsign list editing screen appears.
- 5 Press [A/B].
The Callsign list selection screen appears.

Sorting the Callsign

You can sort the Callsign list.

- 1 Press **[MODE]** in the Callsign list selection screen.
The move position selection screen appears.
- 2 Select a move position and press **[A/B]**.
When you move an item to the end of the list, select [Move to End] and press **[A/B]**.

DIRECT REPLY

This function allows you to reply to a received call by simply pressing **[PTT]** while displaying the interrupt screen in DV and DR mode. The default setting is [On]. When a repeater signal is received in a DR mode and you immediately reply to a CQ or a call to your Callsign, the transmission setting is temporarily changed automatically and you can reply by simply pressing **[PTT]**.

The  icon appears in the interrupt screen when a direct reply is possible in receiving a call. If **[PTT]** is pressed when this icon appears, the setting is automatically changed to the reply setting and transmission becomes possible.

Entire interrupt screen

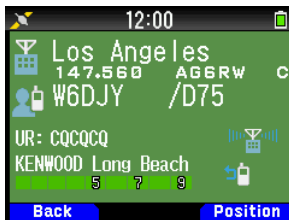

Half interrupt screen

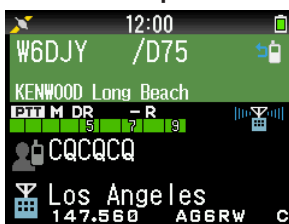

Note:

- ◆ The change of the transmission setting are temporary. After display hold time elapses, it returns to the previous transmission setting.
- ◆ When receiving the repeater frequency in DV mode, you can not reply to a received call by pressing **[PTT]**.

Setting Direct Reply to Off

- 1 Access Menu No. 612.

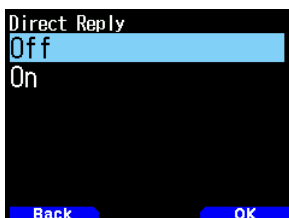

- 2 Select [Off].

Note:

- ◆ You can change the display hold time by Menu No. 643.
- ◆ Direct reply is not possible when display method (Menu No. 640) is set to [Off].
- ◆ When the direct reply is set to [On], the interrupt screen of DV and DR mode is displayed in priority than APRS mode.

AUTO REPLY FUNCTION

This function is to set automatically the Callsign of the other station and reply when a signal to your Callsign is received.

- 1 Select [Auto Reply] in the Digital Function Menu.
- 2 Select [Off], [On], or [On(Voice)].
 - When [On] or [On(Voice)] is set, the  icon appears on the display.

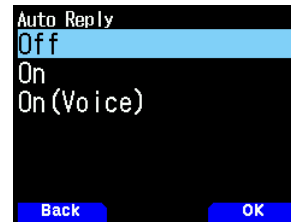

[On]: Transmission is possible with either the transmission message or GPS location information depending on the setting. Voice is not transmitted

[On(Voice)]: An auto reply voice message recorded in the voice message memory in advance can be selected and transmitted. Transmission is possible with either the transmission message or GPS location information depending on the setting.

Selecting the Auto Reply Voice Message

You can select an auto reply voice message from the voice message memory.

- 1 Access Menu No. 312.

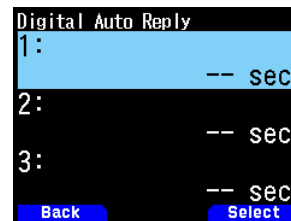

- 2 Select the voice file and press **[A/B]**.

Note:

- ◆ Only one file can be selected.

Auto Reply Timing

You can set the Auto Reply timing.

- 1 Access Menu No. 613.



- 2 Select [Immediate], [5], [10], [20], [30], or [60] seconds.

RX HISTORY

Up to 100 entries containing information such as the Callsigns of the station that transmitted the signal and the repeater used can be stored in RX history for signals received in DV/DR mode. The RX history is not cleared when the power is switched OFF.

Displaying the RX History

- 1 Access Menu No. 600.



- 2 Select a list and press **[A/B]**.
The RX history details screen appears.
- 3 Press **[A/B]**.
The RX history GPS screen appears.

Registering the Callsign from the RX History

- 1 Access Menu No. 600.
- 2 Select the list and press **[ENT]**.
The Callsign registration screen appears.

Clearing the RX History

- 1 Access Menu No. 600.
- 2 Select the list and press **[MODE]**.
The selected RX history are cleared.
All RX history are cleared by pressing and hold **[MODE]**.

TX MESSAGES

A message of up to 20 characters can be transmitted during voice communications in DV/DR mode. Up to five transmission messages can be registered.

Registering the TX Messages

- 1 Access Menu No. 611.

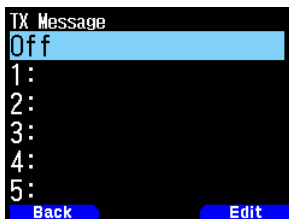

- 2 Select a number for registration and press **[A/B]**.



The TX message editing screen appears.

- 3 Enter the messages.



- 4 Select a number for registration and press **[ENT]**.
The TX messages is selected
Each press of **[PTT]** transmits the selected message.

TX HISTORY

Up to 20 entries can be stored in TX history for signals transmitted in DV/DR mode. The TX history is not cleared when the power is switched off.

Once transmitted, a combination of Callsigns (FROM and TO) is stored together, so you can restore the transmission settings of that time with one touch by pressing **[A/B]** for the selected TX history.

Displaying the TX History

- 1 Select [TX History] in the Digital Function Menu.
The TX history list screen appears.



- 2 Select a list and press **[A/B]**.
The transmission settings are changed and return to the frequency screen.

Note:

- ◆ Entries are not stored in TX history for the data mode, Callsign squelch/ Code squelch, and BK call.

Clearing the TX History

- 1 Select [TX History] in the Digital Function Menu.
- 2 Select the list and press **[MODE]**.
The selected TX history are cleared.
All TX history are cleared by pressing and hold **[MODE]**.

CALL WITHIN ZONE

Call within Zone is an indirect communication via a different repeater within the zone.

Note:

- ◆ Call within Zone is not connected with the Internet.

Setting the Access Repeater (FROM)

- 1 Select [Route Select] in the Digital Function Menu.
- 2 Select [Local NW] and press **[ENT]**.
The World Region selection screen appears.
- 3 Select your area and press **[ENT]**.
The Country & Region selection screen appears.
- 4 Select your Country & Region and press **[ENT]**.
The group selection screen appears.
- 5 Select your area group and press **[ENT]**.
The repeater list selection screen appears.
- 6 Select a nearby repeater from the repeater names or state/prefecture names and press **[ENT]**.
The access repeater is set to [FROM].

Setting the Destination Repeater (TO)

- 1 Press and hold [▲].
The destination selection screen appears. This screen also appears when selecting [Destination Select] in the Digital Function Menu.
- 2 Select [Individual] and press [ENT].
The repeater list appears.
- 3 Select the Callsign from the Callsign lists and press [ENT].
The repeater is set to [TO].
- 4 Press [PTT] to transmit.

SETTING THE ACCESS REPEATER (FROM)

To access a repeater, set the repeater to [FROM]. There are 4 setting methods.

- 1 Setting by Repeater List
- 2 Setting by Nearby Repeaters
- 3 Setting by TX History
- 4 Setting by Direct Input

Setting by Repeater List

- 1 Press and hold [▼].
The FROM selection screen appears.
- 2 Select [Repeater List] and press [ENT].
The World Region, Country & Region, and group selection screen appears.
- 3 Select your area group and press [ENT].
The repeater list selection screen appears.
- 4 Select a nearby repeater from the repeater names or state/prefecture names and press [ENT].
The access repeater is set to [FROM].

Setting by Nearby Repeaters

You can search for a nearby repeater based on the location of your station set by Menu No. 401 and the location information of repeaters. The repeaters located near your station are displayed as the selected candidates among the registered repeater list.

- 1 Press and hold [▼].
The FROM selection screen appears.
- 2 Select [Nearby Repeaters] and press [ENT].
A search begins. Up to 20 nearby repeaters are displayed.
- 3 Select a nearby repeater from the repeater names or repeater Callsigns and press [ENT].
The access repeater is set to [FROM].

Note:

- ◆ It is not possible to select the candidate of any repeater that is 160 km (100 mi) or farther away from your station.

Setting by TX History

You can select among previously accessed repeaters.

- 1 Press and hold [▼].
The FROM selection screen appears.
- 2 Select [TX History] and press [ENT].
TX History selection screen appears.
- 3 Select a repeater in the TX History list and press [ENT].
The access repeater is set to [FROM].

Setting by Direct Input

You can set the repeater by directly inputting the Callsign of the repeater.

- 1 Press and hold [▼].
The FROM selection screen appears.
- 2 Select [Direct Input(RPT1)] and press [ENT].
The direct input screen appears.
- 3 Enter a repeater Callsign and press [ENT].
The access repeater is set to [FROM] when the entered Callsign is in the repeater list.

SETTING THE ROUTE REPEATER (ROUTE)

You can set whether you use the destination repeater Callsign and gateway or not. This is a useful setting when the route setting is not successful.

- 1 Select [Route Select] in the Digital Function Menu.
- 2 Select [Stand Alone], [Local NW], [Over the Gateway], or [Direct Input(RPT2)].

[Stand Alone]: The same Callsign as RPT1 is set to RPT2. The local icon <  > is displayed on the ROUTE screen.

[Local NW]: When a Callsign is set to RPT1, the repeater list selection screen appears. The Callsign of the selected repeater is set to RPT2. The assist icon <  > is displayed on the ROUTE screen.

[Over the Gateway]: When a Callsign is set to RPT1, RPT2 automatically sets the gateway repeater Callsign of RPT1. A repeater without a gateway cannot be selected. The gateway icon <  > is displayed on the ROUTE screen. When a gateway is set, [Local CQ] cannot be set to [TO]. [Individual] or [Gateway CQ] must be set.

[Direct Input(RPT2)]: A directly input destination repeater Callsign is set to RPT2. The icon on the ROUTE screen disappears.

SETTING THE DESTINATION (TO)

You can set the repeater to output the CQ or Callsign of the destination station to call to [TO]. There are 7 setting methods.

- 1 Setting by Local CQ
- 2 Setting by Gateway CQ
- 3 Setting by Individual
- 4 Setting by Reflector
- 5 Setting by Call History
- 6 Setting by Direct Input (URCALL)
- 7 Setting EMR

Note:

- ◆ Gateway CQ and Reflector cannot be selected in DV mode.

Setting by Local CQ

- 1 Press and hold [▲].
The destination selection screen appears. This screen also appears when selecting [Destination Select] in the Digital Function Menu.
- 2 Select [Local CQ] and press [ENT].
CQCQCQ is set to [TO].

Setting by Gateway CQ

- 1 Press and hold [▲].
The destination selection screen appears. This screen also appears when selecting [Destination Select] in the Digital Function Menu.
- 2 Select [Gateway CQ] and press [ENT].
The repeater list selection screen appears.
- 3 Select the destination repeater and press [ENT].
The repeater is set to [TO].

Setting by Individual

- 1 Press and hold [▲].
The destination selection screen appears. This screen also appears when selecting [Destination Select] in the Digital Function Menu.
- 2 Select [Individual] and press [ENT].
The Callsign list appears.
- 3 Select the Callsign and press [ENT].
The selected Callsign is set to [TO].

Setting by Reflector

- 1 Press and hold [▲].
The destination selection screen appears. This screen also appears when selecting [Destination Select] in the Digital Function Menu.
- 2 Select [Reflector] and press [ENT].
The Reflector menu item appears.
- 3 Select the following items and press [ENT].

[Use Reflector]: If your repeater is currently linked to a reflector, select [Use Reflector] and press [ENT]. [CQCQCQ] is set to [TO]. Then press [PTT] to transmit your digital voice signal to the reflector.

[Link to Reflector]: If you want to link the repeater to a reflector, or you want to change to another reflector, select [Link to Reflector] and press [ENT]. Input the reflector's type (REF/DCS/XRF/XLX), number (000 to ZZZ) and module (A to Z), and press [ENT]. A link command (example: [REF030CL]) is set to [TO]. Then press [PTT] to link the repeater to the reflector. Up to 5 reflectors you linked before are shown when you select [Link to Reflector] again.

[Unlink Reflector]: If you want to link the repeater to another reflector, be sure to unlink currently linked reflector. Select [Unlink Reflector] and press [ENT]. [_____]U is set to [TO]. Then press [PTT] to unlink the repeater from the reflector.

[Echo Test]: You can verify how well your digital voice signal is getting into the system. Select [Echo Test] and press [ENT]. Then [_____]E is set to [TO]. Then press [PTT] to transmit your digital voice signal to the system. After releasing [PTT], echo back will be sent back from the repeater.

[Reflector Info.]: You can send the reflector information command. Select [Reflector Info.] and press [ENT]. Then [_____] is set to [TO]. Then press [PTT] to transmit the reflector information command. After releasing [PTT], ID will be sent from the repeater.

Note:

- ◆ To use a hotspot (simplex DV access point), you can store the hotspot's frequency and other information in the Hotspot List (Menu No.230) for using the DR mode Reflector menu above. Please refer to page No.16-16 "HOTSPOT LIST" for details.

Setting by Call History

- 1 Press and hold [▲].
The destination selection screen appears. This screen also appears when selecting [Destination Select] in the Digital Function Menu.
- 2 Select [Call History] and press [ENT].
The Callsign list appears.
- 3 Select the destination Callsign and press [ENT].
The selected Callsign is set to [TO].

Setting by Direct Input (URCALL)

- 1 Press and hold [▲].
The destination selection screen appears. This screen also appears when selecting [Destination Select] in the Digital Function Menu.
- 2 Select [Direct Input(URCALL)] and press [ENT].
The direct input screen appears.
- 3 Enter the destination Callsign and press [ENT].
The destination Callsign is set to [TO].

Note:

- ◆ When entering the destination Callsign by direct input (URCALL), the route setting is not automatically set. Please be sure to set the route setting by [Route Select] in the Digital Function Menu then.

Setting EMR

- 1 Press and hold [▲].
The destination selection screen appears. This screen also appears when selecting [Destination Select] in the Digital Function Menu.
- 2 Select [EMR] and press [ENT].
The EMR is set.

CHECKING THE CALLSIGN SETTING

You can check transmission settings of DV/DR mode before transmission.

- 1 Select [CS Setting] in the Digital Function Menu.
The confirmation screen appears.



```
DR TX Setting
UR: /DF0TK B
R2: AG6RW G
R1: AG6RW C
MY: W6DJY
Back Name
```

- 2 Press [A/B].
Each press switches between name display and Callsign display.

DISPLAYING THE REPEATER DETAILS

You can check the details information of the repeater.

- 1 Select [Repeater Detail] in the Digital Function Menu.
The confirmation screen appears.



- 2 Press [▲]/[▼].
Each press switches between the access repeater details screen and gateway CQ repeater details screen.

FAST DATA COMMUNICATION

Fast data communications can be performed by using the voice band for data communications when operating in DV/DR mode.

- 1 Access Menu No. 984.
Select the method for connecting (USB or Bluetooth) with the external device for data communication.

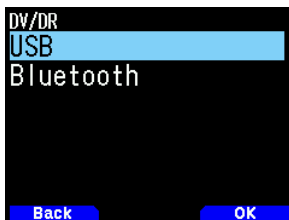

- 2 Select [Data Mode] in the Digital Function Menu.
When the data mode is set, the < DATA > icon appears on the display.

Connecting with a PC

Use a commercially available data communication cable to connect the USB connector of the transceiver to a PC.

Software Setting for Data Communication

Refer to the followings and complete the settings.

Port: Select the COM port number used by this transceiver.

Note:

- ◆ The COM port number used by this transceiver may be 5 or higher depending on the PC environment. In this case, use a communication software that allows you to set the COM port number to 5 or higher.

Data Communication Operation

When performing data communication operation, refer to the instruction manual of the communication software.

- 1 Set the Callsign of your station, the other station, and repeater.
- 2 Perform the operation according to the instruction manual and other documents of the communication software.
- 3 When a text is entered in the communication software screen, that text will be transmitted automatically.

Data TX End Timing

This function is to set the delay time until return from fast data TX to RX in accordance with the TX timing of the PC software.

- 1 Access Menu No. 614.

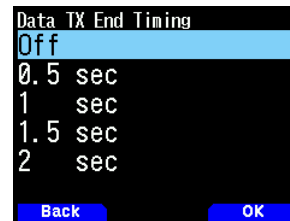

- 2 Select [Off], [0.5], [1], [1.5], or [2] seconds.

EMR COMMUNICATION

The Enhanced Monitor Request (EMR) mode is a function used in DV/DR mode to, for example, contact somebody in an emergency.

Note:

- ◆ This function is forced to open the squelch of all of the transceivers, which have received the EMR signal, and then to the state to receive the signal. And easily send the EMR signal, please note that you will cause to give trouble to the other station.
- ◆ Setting the other station Callsign or CQ are maintained.
- ◆ Selecting EMR in EMR mode will cancel EMR mode.
- ◆ EMR setting is canceled when the power is switched OFF.
- ◆ EMR communication is not recorded in the TX history.
- ◆ Any station that received the EMR communication displays the EMR call icon < EMR > during receiving.

- 1 Select [Destination Select] in the Digital Function Menu.
The destination selection screen appears.
- 2 Select [EMR] and press [ENT].
[EMR] is set.



- 3 Press [PTT] to transmit.

Adjusting the Volume for EMR Signal Reception

You can set the volume level within the range of 1 to 50 when an EMR signal is received. However, if the volume level set by the [VOL] control is higher, the reception will be at that volume.

- 1 Access Menu No. 615.
- 2 Select the volume level among from [1] to [50], and press [A/B].

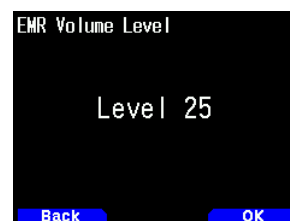

- 3 The volume is set.

RX AFC

This function is to correct a slight frequency offset of the received signal to achieve frequency stability.

- 1 Access Menu No. 616.
- 2 Select [Off] or [On].
[Off]: Turns off the RX AFC.
[On]: Turns on the RX AFC.

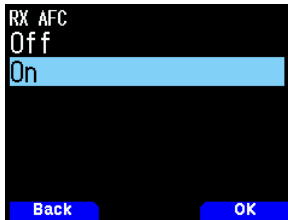

Note:

- ◆ This function does not work with the TX frequency.

FM AUTO DETECTION ON DV

This function is to receive an FM signal if FM signal reception is available when operating in DV mode.

- 1 Access Menu No. 617.
- 2 Select [Off] or [On].
[Off]: Does not receive an FM signal in DV mode.
[On]: Switches to FM mode and receives the FM signal automatically in DV mode.

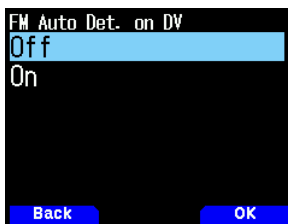

Note:

- ◆ This function is only for DV mode and does not operate in DR mode.

DATA FRAME OUTPUT

This function is to output digital data received by D-STAR from the USB connector.

- 1 Access Menu No. 618.
- 2 Select [All], [Related to DSQ], or [DATA mode].
[All]: Transfers all received data to the USB connector.
[Related to DSQ]: Transfers to the Micro-USB connector linked to the Callsign squelch/ Code squelch. The digital data is not output to the USB connector when the sound is muted by the Callsign squelch/ Code squelch.
[DATA Mode]: Data is output to the USB connector only in DATA Mode.

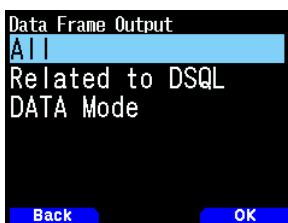

Note:

- ◆ It can also be output from Bluetooth by Menu No.984.

BK (BREAK) CALL

BK (Break) Call is used to simultaneously call two stations that are communicating by the Callsign squelch in DV/DR mode.

BK (Break) Call Function

When you are using the Callsign squelch, the squelch does not open even if a signal that is not to your station is received. When a signal with the BK (Break) Call set to [On] is received, the squelch opens even if the signal is that of the other station with which you are communicating.

When C station calls A station with BK Call [Off]:

A and B Stations are communicating by the Callsign squelch. When C station calls A station, B station does not hear that call.

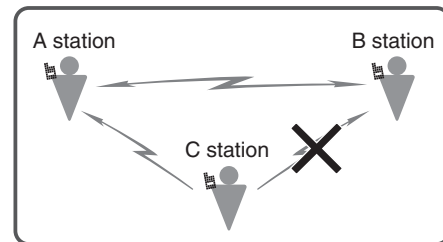

When C station calls A station with BK Call [On]:

Stations A and B are communicating by the Callsign squelch. When C station calls A station, B station also hears that call.

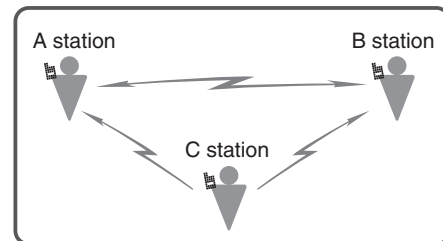

Turning On the BK (Break) Call function

- 1 Access Menu No. 619.
- 2 Select [On] and press [A/B].
When the BK (Break) Call is turned [On], the < BK > icon appears on the display.



- 3 Press [PTT] to transmit to one of the stations.
The other transceiver with the same destination Callsign set for the destination (TO) (i.e., the other station that communicated by the Callsign squelch) can be called.

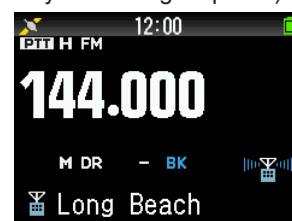

Note:

- ◆ This setting is canceled when the power is switched OFF.

CALLSIGN SQUELCH/ CODE SQUELCH

This function is useful when communicating with the specific stations. The squelch opens and you can call only when the digital code set by your station or the Callsign of your station is received.

Callsign Squelch

The squelch opens only when the received destination Callsign matches that of your station. The squelch does not open if all 8 digits of the Callsign do not match.

- 1 Access Menu No. 620.

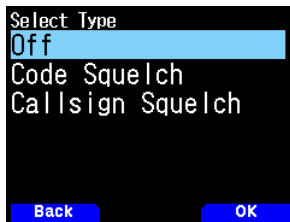

- 2 Select [Callsign Squelch] and press [A/B].

When the Callsign squelch is selected, the < **CCS** > icon appears on the display.

Code Squelch

The squelch opens only when the received digital code matches. This can be set for each band.

- 1 Access Menu No. 620.



- 2 Select [Code Squelch] and press [A/B].

When the code squelch is selected, the < **DCS** > icon appears on the display.

Note:

- ◆ The code squelch is different from DCS (Digital Coded Squelch) in FM mode.

GPS DATA TX MODE

This function is to transmit location information using GPS when operating in DV/DR mode.

- 1 Access Menu No. 630.

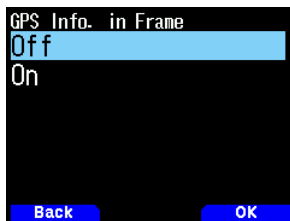

- 2 Select [Off] or [On].

[Off]: Does not transmit my position location information.

[On]: Transmits my position location information.

GPS Sentence

Select the sentence to transmit location information when operating in DV mode. The GPS sentences that can be used with the transceiver are 6 kinds of [GGA], [GLL], [GSA], [GSV], [RMC], [VTG], and [APRS Sentence] but only four of them can be set at the same time.

[GSA], [GSV], [VTG] sentences are transmitted only when Menu No.401(My Position) is set to "GPS".

- 1 Access Menu No. 631.



- 2 Select [\$PGGGA], [\$PGLL], [\$PGSA], [\$PGSV], [\$PRMC], [\$PVTG], or [APRS Sentence]

[\$PGGGA]: Global Positioning System Fix Data.

[\$PGLL]: Geographic position, latitude/ longitude.

[\$PGSA]: GPS DOP and active satellites.

[\$PGSV]: GPS Satellites in view.

[\$PRMC]: Recommended minimum specific GPS/Transit data.

[\$PVTG]: Track made good and ground speed.

[APRS Sentence]: Comply with the APRS protocol and is transmitted according to D-STAR specifications.

Note:

- ◆ When [APRS Sentence] is selected, no other sentences are transmitted.
- ◆ The settings of Menu No.500 (My Callsign in APRS), Menu No.501 (Icon), and Menu No.503 (Status Text) are also applied to the [APRS Sentence] transmission. This is so that APRS data and D-STAR [APRS Sentence] show that they have been sent from the same device.
- ◆ [APRS Sentence] does not include QSY information in the status text.
- ◆ If Menu No.500 (My Callsign in APRS) is not set, the [APRS Sentence] will use the settings of Menu No.610 (My Callsign in DV/DR mode) or Menu No.651 (My Callsign in DV Gateway mode).
- ◆ The D-STAR [APRS Sentence] is transmitted in APRS standard format (uncompressed), not in MicEncoder format. Therefore Position Comments such as "In Service" are not transmitted.

GPS Auto TX

This function is to transmit the positioned GPS data at regular intervals. You can set the interval for transmitting. Location information and other data from the GPS are transmitted at the set interval.

- 1 Access Menu No. 632.

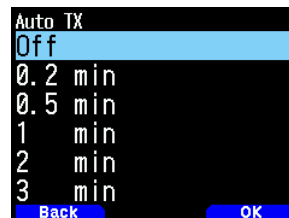

- 2 Select [Off], [0.2], [0.5], [1], [2], [3], [5], [10], [20], [30], or [60] minutes.

Note:

- ◆ Use the GPS Auto TX function in DV mode. Be sure to set to Off in DR mode.
- ◆ When my position is set other than GPS, GPS Auto TX function does not operate.

RX BREAK-IN DISPLAY

This function is to display information received from other station in a Break-In screen. Received information is displayed in a Break-In screen in the operation band.

RX Break-In Display Method

This function is to set the method to display a Break-In screen (display a Break-In only when the received signal is to your Callsign, or display a Break-In for all received signals, etc.).

- 1 Access Menu No. 640.

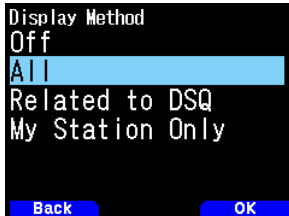

- 2 Select [Off], [All], [Related to DSQ], or [My Station Only].

[Off]: Displays a one-line indication (D-STAR icon and Callsign) for all received calls.

[All]: Displays a Break-In for all received signals.

[Related to DSQ]: Displays a Break-In when the Callsign squelch or Code squelch matches.

[My Station Only]: Displays a Break-In to your station only.

RX Break-In Display Size

This function is to select a display size when displaying information received from the other party (Callsign, message, etc.) as a Break-In display.

Single Band

- 1 Access Menu No. 641.

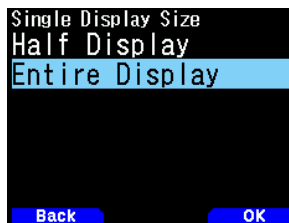

- 2 Select [Half Display] or [Entire Display].

Dual Band

- 1 Access Menu No. 642.



- 2 Select [Half Display] or [Entire Display].

RX Break-In Display Hold Time

This function is to select the hold time to display the Break-In after RX ends. When the set time elapses, the Break-In screen automatically disappears.

- 1 Access Menu No. 643.



- 2 Select [0], [3], [5], [10], [20], [30], [60] seconds or [Infinite].

Note:

- ◆ If 0 second is selected, the RX Break-In screen disappears when RX ends.
- ◆ When there are multiple RX Break-In, only the most recent RX Break-In is displayed.

GPS data display

If the received signal contains GPS data, [Position] is displayed in the lower right key guide display area of the RX Break-In entire display.

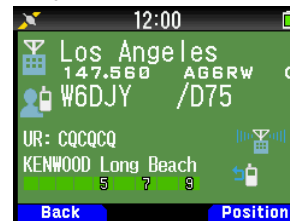

- 1 Press [A/B] to display the location information of the station.

If the received GPS data is the APRS sentence, the icon set by the station is also displayed.

CALLSIGN ANNOUNCE

This function is to announce the Callsign when a D-STAR signal is received. It enables you to know the Callsign without looking at the screen.

- 1 Access Menu No. 644.

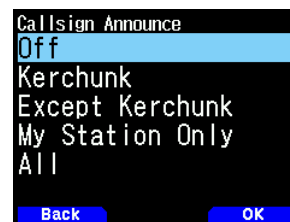

- 2 Select [Off], [Kerchunk], [Except Kerchunk], [My Station Only], or [All].

[Off]: Does not announce the Callsign.

[Kerchunk]: Announces the Callsign when the reception is within 2 seconds.

[Except Kerchunk]: Announces the Callsign when the reception is over 2 seconds.

[My Station Only]: Announces the Callsign for the reception to your station only.

[All]: Announces the Callsign for all receptions.

Note:

- ◆ If the received audio is not output because the digital squelch does not match, the Callsign is not announced.
- ◆ Memo in the Callsign is not announced.
- ◆ The Callsign Announce (menu No. 644) operates regardless of the Voice Guidance mode setting (menu No. 916).

STANDBY BEEP

This function is to notify with a beep sound that transmission has ended when a D-STAR signal is received.

- 1 Access Menu No. 645.

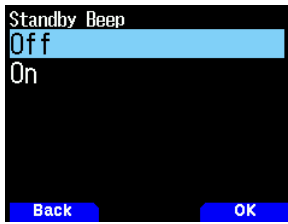

- 2 Select [Off] or [On].

[Off]: Does not sound the standby beep.

[On]: Sounds the standby beep.

Note:

- ◆ The standby beep volume can be changed in Menu No. 915.
- ◆ When the reception sound is muted by the Callsign squelch/Code squelch, the standby beep does not sound.

DV GATEWAY MODE

In DV Gateway mode, the transceiver is connected to a Windows PC or Android device with a third-party application installed via USB or Bluetooth, and D-STAR operation is available over the Internet instead of using Amateur Radio waves.

A dedicated My Callsign in DV Gateway mode is required for operation.

The demodulation mode is set to DV and the display format is similar to DR mode. The destination or control command is displayed in the "TO" area, and My Callsign is displayed in the "FROM" area.

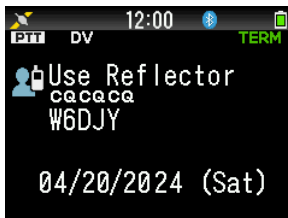

Note:

- ◆ For specific instructions on how to operate DV Gateway communication, please refer to the description of the third-party application to be used. JVCKENWOOD does not provide applications for DV Gateway communication.

DV Gateway Mode Configuration

Set the DV Gateway mode.

- 1 Access Menu No. 650.

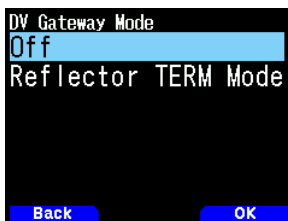

- 2 Select [Off] or [Reflector TERM Mode].

[Off]:

Turns the DV Gateway mode OFF.

[Reflector TERM Mode]:

Activates the Reflector Terminal mode.

The following operations are prohibited when the Reflector Terminal mode is started.

Band A	Operating the [Mode] [VFO] [MR] [ALL] Press and hold [DOWN]
Single-Band A	Operating the [A/B]
Band B	Operating the [DUAL]

Note:

- ◆ Reflector Terminal mode only works in band A. When band A is turned off, Reflector Terminal mode is disabled.

My Callsign

A dedicated My Callsign must be set for operation in DV Gateway mode.

Up to 6 Callsigns can be registered the same way as Menu No.610 (My Callsign in DV/DR mode).

- 1 Access Menu No. 651.
- 2 Select a number for registration and press **[A/B]**.
- 3 Input your Callsign.
 - For the character input procedure, refer to page No.6-1.

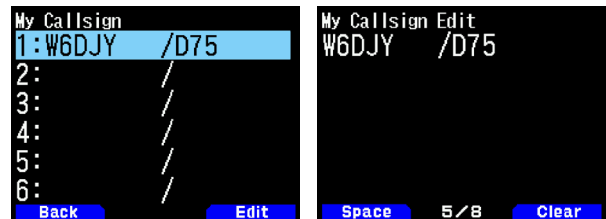

RPT1 Configuration

Sets RPT1 used for DV Gateway mode.

- 1 Access Menu No. 652.



- 2 The default is "DIRECT". Change only if necessary.

RPT2 Configuration

Sets RPT2 used for DV Gateway mode.

- 1 Access Menu No. 653.



- 2 The default is "DIRECT". Change only if necessary.

Device Information

Confirm the device-name used in DV Gateway mode.

- 1 Access Menu No. 654.

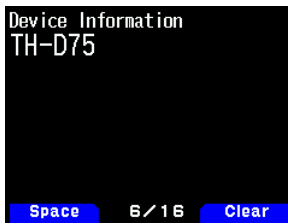

DV Gateway Mode Interface Setting

Set the interface (USB or Bluetooth) for connecting to external devices (Windows PC or Android device) when in DV Gateway mode.

- 1 Access Menu No. 985.

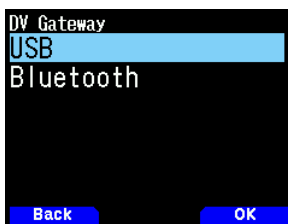

- 2 Select [USB] or [Bluetooth].

DR SCAN

This function scans the stations in the repeater list or hotspot list in DR mode.

- 1 Press and hold [VFO], or select [DR Scan] in the Digital Function Menu.

DR Scan screen appears.



- 2 Select an item and press [VFO], [ENT], or [A/B]..

[FROM] and MHz dot flash and scan starts in the increasing direction of repeater numbers from the last repeater. The scan direction can be changed with [▲]/[▼] or [ENC] control.

DR Scan Menu

DR Scan Menu	Operation
Nearby Repeaters	Search for nearby repeaters (up to 20 repeaters) that are near your station (within a range of 160 km (100 mi)) among D-STAR repeaters.
World Region	Search for the repeaters that are communicating among all D-STAR repeaters that belong to the World Region.
Country & Region	Search for repeaters that are communicating among all D-STAR repeaters that belong to the Country & Region.
Group	Search for repeaters that are communicating among all D-STAR repeaters that belong to the Group.
Hotspot	Find the hotspots that are communicating in the hotspot list.

- 3 Press [ENT].

Scan stops.

Note:

- ◆ Repeaters and hot spot specified for Repeater Lockout can not be scanned.
- ◆ When scanning by [Nearby Repeaters], [Not Found] is displayed if there is no repeater that can be used within the range of 160 km (100 mi) from your station.
- ◆ [Nearby Repeaters] scan will not operate if GPS data is not received.
- ◆ Even if GPS is not positioning, the transceiver searches for nearby repeaters by the stored GPS data.
- ◆ If there is no more than one repeater registered in the repeater list, a repeater scan can not be performed.

REPEATER SCAN LOCKOUT

This function is to exclude and skip any list from the scan targets when D-STAR repeater or hotspot lists are scanned.

Group Lockout Setting

You can lock out all repeaters in a specific repeater group.

- 1 Access Menu No. 210.
World Region selection screen appears.
- 2 Select a World Region and press [ENT].
Country & Region selection screen appears.
- 3 Select a Country & Region and press [ENT].

Group selection screen appears

- 4 Select a group to be skipped and press [A/B].

The lockout icon <  > appears.

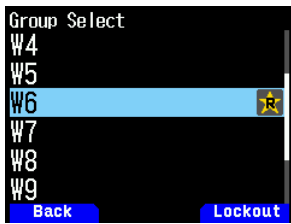

- 5 Press [PTT] to return to the frequency screen.

Individual Lockout Setting

You can lock out the specific repeaters in a repeater group.

- 1 Access Menu No. 210.
World Region selection screen appears.
- 2 Select a World area and press [ENT].
Country & Reagion selection screen appears.
- 3 Select a Country & Reagion and press [ENT].
Group selection screen appears
- 4 Select a group and press [ENT].
Repeater list selection screen appears.
- 5 Select a repeater and press [A/B].

The lockout icon <  > appears.

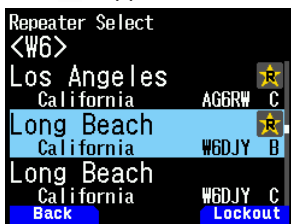

- 6 Press [PTT] to return to the frequency screen.

Note:

- ◆ [FROM] or [TO] setting screen of the transmission settings can be accessed even if repeaters are set to Repeater lockout.
- ◆ Even if repeaters set to Repeater lockout are registered to a memory channel, they will not be the memory channel lockout.

REPEATER LIST

The repeater list is pre-installed at the time of purchase. Up to 1,500 repeaters can be registered in the repeater list. The repeater list can be added, edited, and deleted as needed. The repeater list is not cleared even after a full reset.

Displaying the Repeater List

- 1 Access Menu No. 210.
World area selection screen appears.
- 2 Select a World area and press [ENT].
Country & Reagion selection screen appears.
- 3 Select a Country & Reagion and press [ENT].
Group selection screen appears.
- 4 Select a group and press [ENT].
Repeater list selection screen appears.
- 5 Select a repeater and press [ENT].
Repeater details screen is set.
- 6 Press [PTT] to return to the frequency screen.

Sorting the Repeater List

- 1 Select the repeater you want to move on the repeater selection screen.
Repeater list menu screen appears.
- 2 Press [MENU]
- 3 Select [Move] and press [A/B].
Repeater list menu screen appears.
- 4 Select move position and press [A/B].
If you move an item to the end of the list, select [Move to End] and press [A/B].

Editing the Repeater List

You can edit the repeater information.

- 1 Select the repeater you want to edit on the repeater selection screen.
- 2 Press [MENU].
- 3 Select [Edit] and press [A/B].
Repeater list editing screen appears.
- 4 Select an item and press [ENT].
Editing screen of the selected item appears.
- 5 Edit the contents and press [Write] on the screen.
Editing is completed.
- 6 Press [A/B] after editing.
The Repeater list selection screen appears.

Note:

- ◆ After editing in each edit window, the edited content will not be saved unless you confirm it by pressing [Write] in the repeater list edit window.
- ◆ The repeater which is set as the access repeater (FROM) or destination repeater (TO) in DR mode cannot be edited. Please edit the repeater information after changing the repeater setting.

Repeater List Editing Menu

Editing Menu	Operation
Name editing screen	Edit the Repeater name.
Sub Name editing screen	Edit the Repeater sub-name.
Callsign (RPT1) editing screen	Edit the Repeater Callsign.
Gateway (RPT2) editing screen	Edit the Gateway Callsign.
Lockout selecting screen	Set [On] or [Off] to the repeater lockout.
Frequency editing screen	Edit the frequency. The frequency is corrected at 5 kHz step.
Shift editing screen	Select shift direction. Select [Off], [Plus], or [Minus].
Offset editing screen	Edit the offset frequency. The offset frequency is corrected at 5 kHz step.
Position accuracy editing screen	Select [Invalid], [Approximate], or [Exact].
Latitude editing screen	Edit the latitude.
Longitude editing screen	Edit the longitude.
Time zone editing screen	Edit the time zone.

Clearing the Repeater List

You can clear the specific repeater in the repeater list.

- 1 Select the repeater in the repeater list selection screen.
- 2 Press **[MENU]**.
Repeater list menu screen appears.
- 3 Select **[Clear]** and press **[A/B]**.
The confirmation screen appears.
- 4 Press **[A/B]**.
The repeater is cleared and repeater list selection screen appears.

Note:

- ◆ The repeater which is set as the access repeater (FROM) or destination repeater (TO) in DR mode cannot be cleared. Please clear the repeater after changing the repeater setting.

Adding the Repeater List

You can add the repeater information.

- 1 Press **[MENU]** in the repeater list selection screen.
- 2 Select **[Add]** and press **[A/B]**.
Repeater list menu screen appears.
- 3 Select the item you want to add/ edit and press **[Ent]**.
Editing screen of the selected item appears.
- 4 Add/edit the contents and press **[Write]** on the screen.
Editing is completed.
- 5 Press **[A/B]** after editing.
The Repeater list selection screen appears.

HOTSPOT LIST

This is the memory channel list for using hotspots to connect to the D-STAR reflector.

Up to 30 hotspots can be registered in the hotspot list.

The hotspot list is not cleared even after a full reset.

Adding the Hotspot List

At the time of purchase, nothing is registered in the hotspot list. Add the hotspot information if necessary.

- 1 Access Menu No. 230.
The hotspot selection screen will appear on the display.



- 2 Press **[MENU]** on the hotspot selection screen.
The hotspot list menu will appear on the display.
- 3 Select "Add" and press **[A/B]**.

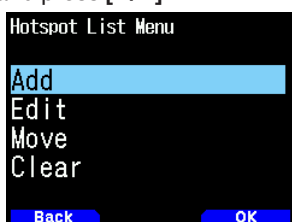

- 4 Select the item you want to add/ edit and press **[Ent]**.
The hotspot list menu will appear on the display.

- 5 Add/edit the contents and press **[Write]** on the screen.
Editing is completed.
- 6 After adding/editing, press **[A/B]**.
Return to the hotspot list screen.

Note:

- ◆ "Callsign (RPT1)" and "Gateway (RPT2)" in the hotspot list to be added can be "W6DJY B", "W6DJY G", or both, depending on the callsign set on the node device. Set to "DIRECT". Follow the recommended settings for the node equipment.

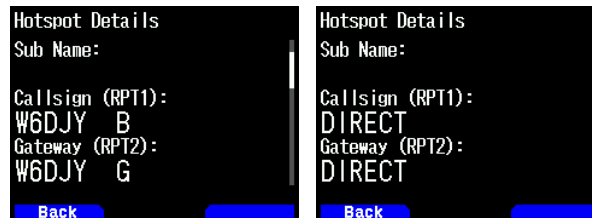

- ◆ If you try to add a list when the number of registered items reaches the upper limit (30 items), the list addition error screen is displayed.
- ◆ After editing in each edit window, the edited content will not be saved unless you confirm it by pressing **[Write]** in the repeater list edit window.

Sorting the Hotspot List

- 1 Select the hotspot you want to move on the hotspot selection screen.

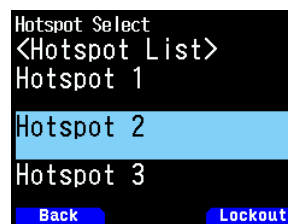

- 2 Press **[MENU]** on the hotspot selection screen.
The hotspot list menu will appear on the display.

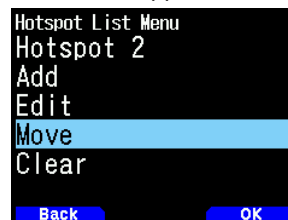

- 3 Select "Move" and press **[A/B]**.
- 4 Select the destination and press **[A/B]**.
If you want to move to the end of the list, select <Move to the end> and press **[A/B]**.

Editing the Hotspot List

You can edit the Hotspot list.

- 1 Select the hotspot you want to edit on the hotspot selection screen.

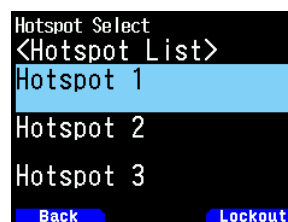

- 2 Press **[MENU]**.

Hotspot list menu screen appears.

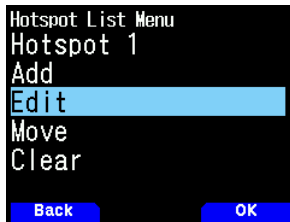

- 3 Select **[Edit]** and press **[A/B]**.

Hotspot list editing screen appears.



- 4 Select an item and press **[ENT]**.
Editing screen of the selected item appears.
- 5 Edit the contents and press **[Write]** on the screen.
Editing is completed.
- 6 Press **[A/B]** after editing.
The Hotspot list selection screen appears.

Note:

- ◆ The hotspot which is set as the access repeater (FROM) in DR mode cannot be edited. Please edit after changing the access repeater setting.

Clearing the Hotspot List

Clear hotspot from the hotspot list.

- 1 Select the hotspot you want to clear on the hotspot selection screen.



- 2 Press **[MENU]** on the hotspot selection screen.
The hotspot list menu will appear on the display.
- 3 Select "Clear" and press **[ENT]**.

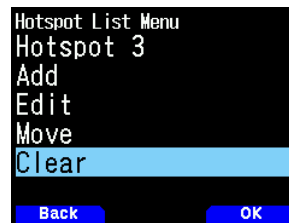

- 4 Press **[A/B]**.
The hotspot is deleted and returns to the hotspot selection screen.

Note:

- ◆ The hotspot which is set as the access repeater (FROM) in DR mode cannot be cleared. Please clear the hotspot information after changing the access repeater setting.

Hotspot List Editing Menu

Editing Menu	Operation
Name editing screen	Edit the Hotspot name.
Sub Name editing screen	Edit the Hotspot sub-name.
Callsign (RPT1) editing screen	Edit the Repeater Callsign.
Gateway (RPT2) editing screen	Edit the Gateway Callsign.
Lockout selecting screen	Set [On] or [Off] to the DR Scan lockout.
Frequency editing screen	Edit the frequency. The frequency is corrected at 5 kHz or 6.25 kHz step.
Shift editing screen	Select shift direction. Select [Off], [Plus], or [Minus].
Offset editing screen	Edit the offset frequency. In the case of Simplex, set all girders to "0". The offset frequency is corrected to 5kHz or 6.25kHz step.
Position accuracy editing screen	Select [Invalid], [Approximate], or [Exact].
Latitude editing screen	Edit the latitude.
Longitude editing screen	Edit the longitude.
Time zone editing screen	Edit the time zone.

USB FUNCTION

The transceiver operates as a USB 2.0 compliant USB device. It also supports the following device classes.

CDC: Communication Device Class

ADC: Audio Device Class 1.0

MSC: Mass Storage Class

Note:

- ◆ The transceiver does not support being connected with a PC via a USB hub. Use a commercially available cable to connect the transceiver directly to a USB port of the PC.

CONNECTING WITH A PC

Connecting the transceiver to a PC enables you to use the memory control program MCP-D75 to configure various settings and access from the PC to the microSD memory card in the transceiver.

To connect the transceiver with a PC, you need to install the virtual COM port driver on the PC.

Download the memory control program MCP-D75 and virtual COM port driver from the following URL.

https://www.kenwood.com/i/products/info/amateur/software_download.html

(This URL may change without notice.)

Note:

- ◆ Never connect the transceiver and a PC with a USB cable until installation of the virtual COM port driver downloaded from the above URL is completed. If the transceiver and a PC are connected without installing the virtual COM port driver, the wrong driver that does not support the transceiver will be installed and communicating correctly with the PC will become impossible. To prevent the wrong driver from being installed, be sure to complete the installation of the virtual COM port driver before connecting the transceiver with the PC.

Connecting to the PC

Connect to the PC using a commercially available USB cable (USB Type-C™).

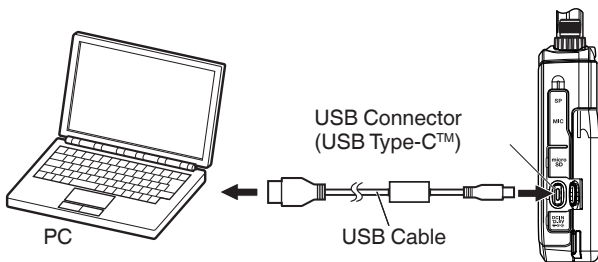

Note:

- ◆ The transceiver can not be connected to the COM port of the PC.
- ◆ The communication speed (baud rate) is maximum 12 Mbps for USB.

OPERATION SETTING

You can select whether the transceiver operates as a USB Type-C™ Connector and audio device or operates as a mass storage class device when it is connected with a PC.

- 1 Access Menu No. 980.

The USB operation function selection screen appears.

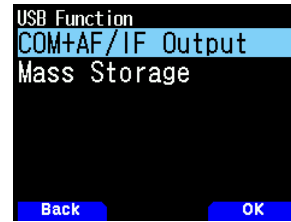

- 2 Select [COM + AF/IF Output] or [Mass Storage].

[COM + AF/IF Output]: The transceiver operates as a virtual COM port for serial data communication, and outputs one of the AF, IF, or detection signals by USB audio. (IF/detection signal output can be switched by Menu No. 102.)

[Mass Storage]: The transceiver enters mass storage mode. You can access the microSD memory card of the transceiver from a PC. The transceiver will be displayed as a removable disk on the PC.

- Activating Mass Storage mode will unmount the microSD memory card inserted in the transceiver. GPS logs and received audios cannot be recorded. Exit Mass Storage mode and remount the microSD memory card.
- If Mass Storage is selected, the [Mass Storage Mode] screen appears when the transceiver is connected to a PC.



Disconnect

- 1 Click [Safely Remove Hardware] on the PC.
- 2 Disconnect the USB cable from the PC.

Note:

- ◆ When [Mass Storage Mode] is started, check that a microSD card is inserted in the transceiver.
- ◆ In [Mass Storage Mode], operations other than switching the power off cannot be performed.
- ◆ In [Mass Storage Mode], RX and TX cannot be performed.
- ◆ In [Mass Storage Mode], GPS log recording and reception sound recording cannot be performed.

SETTING USB AUDIO OUTPUT LEVEL

Adjust the USB audio output level to the PC.

- 1 Access Menu No. 91A.



- 2 Select among from [Level 1] to [Level 7].

18 Bluetooth®

If you purchase a commercially available headset that is compatible with Bluetooth, you can connect the transceiver and headset to perform communication wirelessly.

For example, you can wirelessly connect them with the transceiver as the main device and the commercially available headset or other device as the sub device.

The transceiver supports the following profiles.

HSP (Headset Profile):

Profile for communicating with headsets.

SPP (Serial Port Profile):

Profile used for setting up virtual serial ports on two devices (e.g. PCs) and then connecting those devices.

Note:

- ◆ Profiles are Bluetooth connection protocols.
- ◆ Purchase a commercially available headset or other device that is compatible with Bluetooth.
- ◆ With Bluetooth communication, the communication distance varies significantly depending on the influence of nearby equipment. Interference from equipment such as a microwave oven or a wireless LAN will influence the communication distance. In such a case, try stopping the other wireless communication, stopping use of the microwave oven or other equipment, and moving the transceiver away from any nearby equipment. The communication problem may also be resolved by moving the Bluetooth device and transceiver as close to each other as possible.

TURNING ON/ OFF THE Bluetooth FUNCTION

You can turn On/ Off the Bluetooth function.

- 1 Access Menu No. 930.

When the Bluetooth function is turned on, <📶> appears on the display.

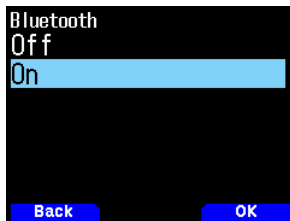

[On]: Turns on the Bluetooth function.

[Off]: Turns off the Bluetooth function.

Connecting with a Headset (Pairing)

When connecting the transceiver with a Bluetooth compatible device, you need to first pair the devices. Pairing is a function for registering devices for a Bluetooth connection as a connection pair.

The following explains how to connect via Bluetooth using the example of a commercially available headset.

Note:

- ◆ For the device to be connected with the transceiver via Bluetooth, be sure to purchase a headset or other device that is compatible with Bluetooth. Also refer to the instruction manual of the device.
- ◆ A connection may not be possible depending on the specifications or settings of the device. There is no guarantee that the transceiver will be able to communicate wirelessly with all Bluetooth devices.
- ◆ The audio bandwidth supported in HSP (Headset Profile) is 4 kHz and below. The voice quality of the received audio with a signal component of 4 kHz and above such as FM radio, may sound different from speakers or earphones.

- 1 Access Menu No. 930 to turn on the Bluetooth function.
- 2 Place the headset (device to be connected) near the transceiver.
 - Place it within approximately 1 meter each other.
- 3 Set the headset (device to be connected) to the pairing mode (Bluetooth connection standby state).
 - For how to enable the pairing mode, refer to the instruction manual of the headset (device to be connected).
- 4 Access Menu No. 932. A device search begins and the recognized device is added to the Bluetooth device search list.



- 5 Select the device to be connected.

When connecting the device that is already selected, move to step 6.

- If you select the device and press [▶], the Bluetooth device information screen appears. You can confirm the device name, device address, and device class.

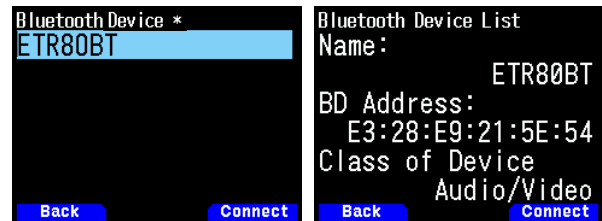

- 6 Press [A/B].

[Connecting. . .] screen appears.

- 7 Make the connection operation by the headset.

Since the connection operation depends on the headset, refer to the instruction manual of the headset.

When the connection of the headset is completed, "Connected Bluetooth Device" is displayed at the top of the display.

After that, <📶> appears on the display.



Note:

- ◆ The volume of the headset can not be adjusted by the [VOL] control of the transceiver. Adjust the volume by the headset volume.

Entering the PIN Code

When searching for the device, you may be requested to enter the PIN code depending on the device to be connected.

When Requested to Enter the PIN Code

The PIN code input screen appears. Refer to the instruction manual of the device to be connected and enter the PIN code using the number keys and press [A/B].

If you press [▶] when the PIN code input screen is displayed, the Bluetooth device information screen appears. You can confirm the device name, device address, and device class.

Note:

- ◆ The PIN code differs depending on the device to be connected. Refer to the instruction manual of the Bluetooth device and enter the correct PIN code.

Disconnecting from a Bluetooth Device

You can disconnect a connected Bluetooth device to stop communication.

- 1 Access Menu No. 933.
- 2 Select the device.
 - When disconnecting the device that is already selected, move to step 3. If you press [▶], the Bluetooth device information screen appears. If you select the device to be disconnected and press [▶], the Bluetooth device information screen appears. You can confirm the device name, device address, and device class. Pressing [MODE] returns to the previous screen.

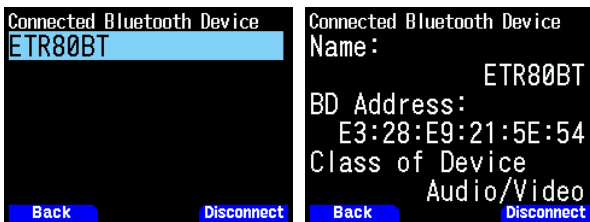

- 3 Press [A/B].

The disconnection process begins.

 - If 30 seconds or more passes during the disconnection process, the Bluetooth device disconnection failure screen appears. Pressing [A/B] returns to the frequency screen. Perform the procedure again from step 1.

Note:

- ◆ When disconnecting from a PC, please make a disconnecting operation by the PC.

CONNECTING BY THE PAIRED DEVICE LIST

A device that has been paired once is registered to the device list as a paired device. Select and connect to a device from the paired device list.

Connecting by the Device List

- 1 Access Menu No. 931.

The device list screen appears.

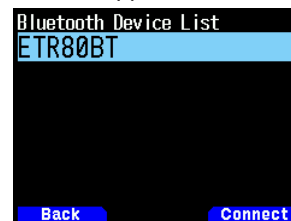

- 2 Select the device to be connected.

When connecting the device that is already selected, proceed to step 3.

If you select the device to be connected and press [▶], the Bluetooth device information screen appears. You can confirm the device name, device address, and device class of the device to be connected.

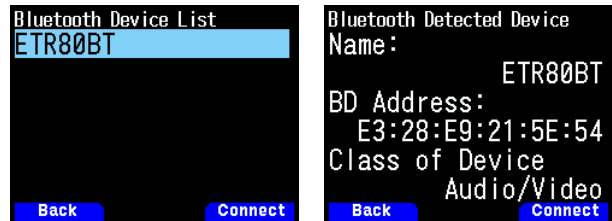

- 3 Press [ENT].

[Connecting. . .] screen appears.
- 4 Make the connection operation by the headset.

When the headset is connected, <Bluetooth icon> appears on the display.

 - Since the connection operation depends on the headset, refer to the instruction manual of the headset.

Displaying the Device List Menu Screen

If you select the device to be connected and then press [MENU], the device list menu screen appears. Select [Connect].

If you press [▶] from the device list menu screen, the Bluetooth device information screen appears. You can confirm the device name, device address, and device class of the device to be connected. Pressing [MODE] returns to the previous screen.

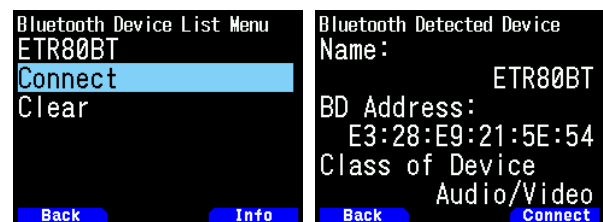

Clearing Devices by the Device List

Clear a paired device by the device list.

- 1 Access Menu No. 931.

The device list screen appears.

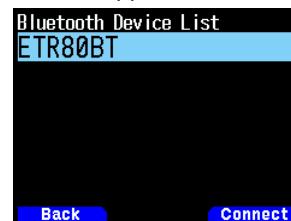

- 2 Press [MENU].

The device list menu screen appears.

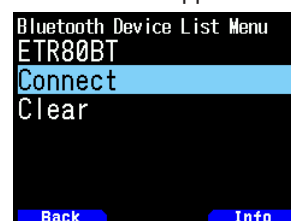

3 Select [Clear] and press [ENT].

The device clear confirmation screen appears.



4 Press [A/B].

The selected device is cleared and the device list screen reappears.

Note:

- The default setting for "Bluetooth Auto Connect" is [On]. If the power of the transceiver is turned On, the transceiver will be automatically connected to the Bluetooth device that was connected previously.

CONNECTING TO A PC VIA Bluetooth

You can connect a Bluetooth compatible USB adapter to a PC that does not support Bluetooth and then connect the transceiver and PC wirelessly. The following explains the example of connecting with a PC that has a Bluetooth compatible adapter connected.

A Bluetooth compatible adapter is an adapter that connects to a PC without a Bluetooth function to enable a wireless connection between a device with a Bluetooth function such as headphones and the PC.

Note:

- For information how to connect with a Bluetooth compatible adapter and a PC, refer to the instruction manual of the PC and adapter.

Pairing between the transceiver and PC

This function is for searching for the transceiver from the PC.

1 Access Menu No. 934.

The pairing waiting screen appears.



- A countdown begins from 60 seconds. After 60 seconds elapse, replying to the device search stops and the menu screen reappears. The countdown continues until pairing completes.
- Perform a pairing operation from the PC.
 - When paring by a PC, the passkey is displayed on the PC and transceiver. When confirming the operation by a PC and pressing [A/B], the paring completed screen appears.
- Press [A/B] to return to the frequency screen.

Note:

- Once pairing with a PC is complete, multiple COM ports may appear on the PC, depending on the PC with built-in Bluetooth function or Bluetooth USB adapter used. In this case, as only one COM port can be used, use the memory control program MCP-D75 and use a normal communication port.
- When using with a PC or USB adapter which supports Bluetooth version 2.0 or earlier, passkey is not displayed. In this case, the input screen of the PIN code on the PC side is displayed. Please enter [0000] in this case.
- Regardless of the transfer rate (baud rate) setting in a PC, transfer rate (baud rate) between the transceiver and PC are USB (up to 12 Mbps) or Bluetooth (up to 128 kbps).

Bluetooth Device Information

You can confirm the device name, device address, and device class of the transceiver. The Bluetooth device name can be changed.

To Change the Device Name

1 Access Menu No. 935 and then set the setting.

The Bluetooth device information screen for the transceiver appears.

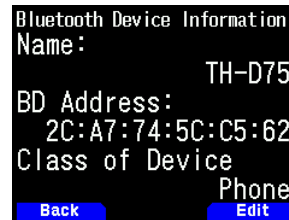

2 Press [A/B].

The mode becomes the text input mode.

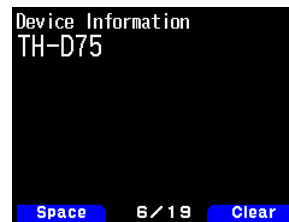

3 Select the characters you wish to input.

For the detailed character input procedure.

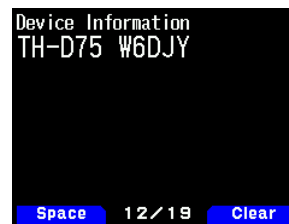

4 Press [ENT].

The device name is changed.

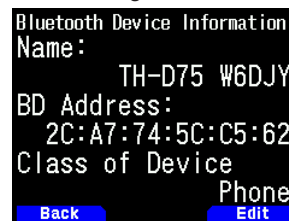

Bluetooth Auto Connect

This function is for automatically connecting with the Bluetooth device used last time when the power of the transceiver is turned on.

- 1 Access Menu No. 936.

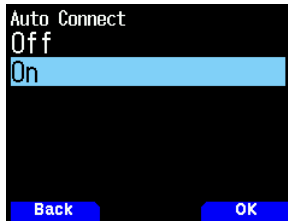

- 2 Select [On] or [Off].
[On]: Turns ON the auto connect function.
[Off]: Turns OFF the auto connect function.

Note:

- ◆ This function does not support automatic connection with a PC.
-

19 microSD MEMORY CARD

Supported microSD Memory Card

Note:

- ◆ A microSD memory card or microSDHC memory card is not supplied with this product. Purchase a commercially available product.
- ◆ A microSDXC memory card can not be used with this transceiver.

The following table shows the microSD memory card and microSDHC memory card for which JVCKENWOOD has verified operation.

In this manual, microSD memory cards and microSDHC memory cards are referred to as microSD memory cards.

Memory Card	Size
microSD	2 GB
microSDHC	4 GB
	8 GB
	16 GB
	32 GB

- Regardless of the above table, JVCKENWOOD does not guarantee the operation of all microSD memory cards.
- The operation of a microSD memory card formatted with other than the transceiver is not guaranteed.
- The larger the capacity of the microSD memory card used, the longer it takes to recognize the microSD memory card.
- Please note that the data in the microSD memory card may be damaged or erased in cases such as the following.
 - If the microSD memory card is removed without performing the [Safely Remove] operation (unmount).
 - If the battery pack or battery case is removed during operation.
 - If the battery pack or alkaline batteries run out of power during operation.
 - If the power from an external power supply suddenly stops without installing the battery pack.

Note:

- ◆ For precautions regarding the microSD memory card, refer to the instruction manual of the microSD memory card.
- ◆ The file system is FAT32.
- ◆ Maximum number of files in a folder are 255 files.

Data That Can Be Saved to a microSD Memory Card

The following data can be saved.

- Various Configuration Data
Configuration data such as the memory data, Callsign list, and repeater list registered to the transceiver can be saved.
- Recording Data
The data in which the QSO communication (audio) with other stations are recorded can be saved.
- QSO History Log
The QSO history log can be saved to a log file.
- Position Information Received by GPS
The position information received by GPS can be saved to a log file as tracks.

Hierarchy of microSD Memory Card

The following folders are automatically created in a microSD memory card that is mounted on the transceiver.

The hierarchy of the microSD memory card becomes as shown in the following diagram.

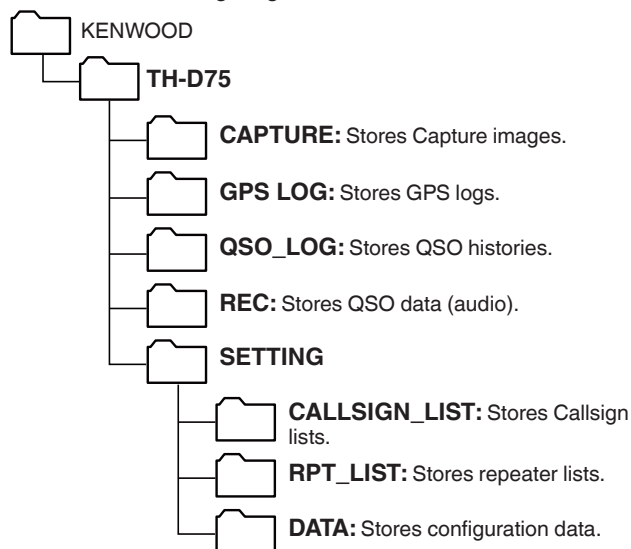

INSERTING/ REMOVING A microSD MEMORY CARD

Inserting (Mounting) a microSD Memory Card

- 1 Switch OFF the power of the transceiver.
- 2 Open the cap of the microSD memory card slot on the side.
- 3 Insert the microSD memory card.
 - With the contacts of the microSD memory card at the front, insert the microSD memory card into the microSD memory card slot until you hear it lock into place with a click. The transceiver automatically recognizes the microSD memory card and <SD> flashes on the display. It changes to be displayed if the card enters the readable/writable state correctly.

Note:

- ◆ When inserting a microSD memory card, do not touch its contacts.
- ◆ Do not remove a microSD memory card while data is being written or read. Doing so may cause the data on the microSD memory card to be damaged or erased.

- 4 Close the cap.

Close the cap of the microSD memory card slot on the side properly.

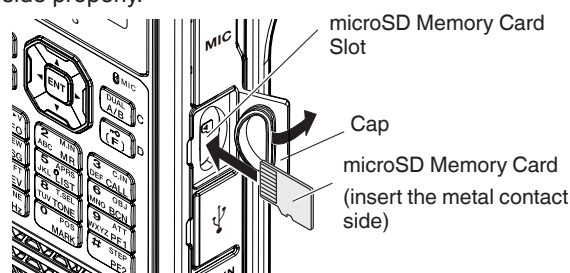

Note:

- ◆ Do not insert a microSD memory card the opposite way around or use force to insert it. Doing so may damage the microSD memory card or slot.

Removing (Unmounting) a microSD Memory Card

When removing a microSD memory card, be sure to perform the operation to safely remove (unmount) it.

Note:

- ◆ Removing a microSD memory card without unmounting it correctly may damage it.

1 Access Menu No. 820.

The microSD memory card is unmounted. When unmounting is completed, the completed confirmation screen appears.

2 Press [A/B].

Unmounting completes and the frequency screen reappears.

3 Remove the microSD memory card.

- When removing a microSD memory card, push until you hear it unlock with a click and remove it.

FORMATTING A microSD MEMORY CARD

When using a new microSD memory card, format the microSD memory card as described below. All the data in the microSD memory card will be erased when the microSD memory card is formatted.

1 Insert the microSD memory card into the transceiver.

2 Switch ON the power of the transceiver.

3 Access Menu No. 830.

The format confirmation screen appears.

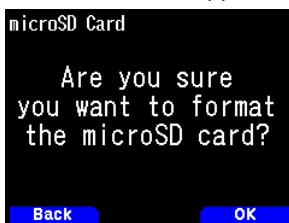

4 Press [A/B].

Formatting begins. When formatting is completed, the completed confirmation screen appears.

5 Press [A/B] again.

Formatting completes and the frequency screen reappears.

HOW TO USE A microSD MEMORY CARD

Saving the Configuration Data

1 Access Menu No. 800.

Saving begins. When saving is completed, the data writing completed screen appears.

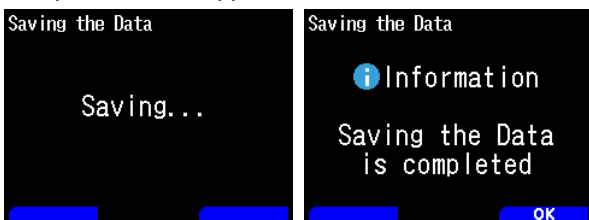

2 Press [A/B].

The frequency screen reappears.

Saving the Configuration Data + Voice message

1 Access Menu No. 801.

Saving begins. When saving is completed, the data writing completed screen appears.

2 Press [A/B].

The frequency screen reappears.

Note:

- ◆ This menu cannot be accessed when a voice message is not recorded.

Saving the Repeater list Data

1 Access Menu No. 802.

Saving begins. When saving is completed, the data writing completed screen appears.

2 Press [A/B].

The frequency screen reappears.

Saving the Callsign list Data

1 Access Menu No. 803.

Saving begins. When saving is completed, the data writing completed screen appears.

2 Press [A/B].

The frequency screen reappears.

Note:

- ◆ This menu cannot be accessed when a microSD memory card is not inserted in the transceiver.
- ◆ Only up to 19 characters can be displayed for a file name in the file list screen.

LOADING MEMORY DATA

Note:

- ◆ When the files are downloaded from our web site or created by non-PC applications, the operations can not be guaranteed.

Import the Configuration Data

1 Access Menu No. 810.

The file type selection screen appears.

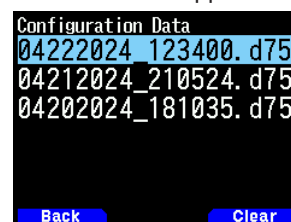

2 Select the data and press [ENT].

Importing begins.

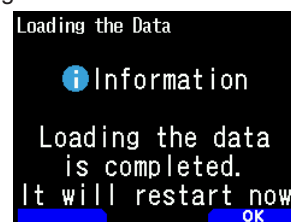

3 Press [A/B] to restart the transceiver.

Import the Configuration Data + Voice message

- 1 Access Menu No. 811.
The file type selection screen appears.

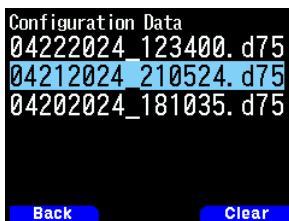

- 2 Select the data and press [ENT].
Importing begins.

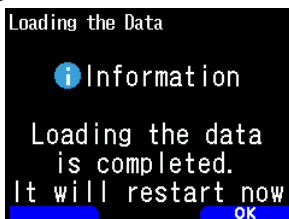

- 3 Press [A/B] to restart the transceiver.

Note:

- ◆ This menu cannot be accessed when a voice message is not recorded.

Import the Repeater list Data

- 1 Access Menu No. 812.
The repeater list appears.

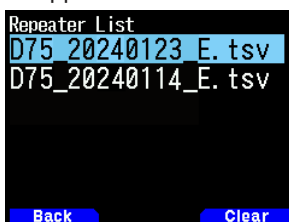

- 2 Select [Data For TH-D75A], [Data For TH-D75E], or [Data For TH-D75] and press [A/B].

[Data For TH-D75A]: Repeater lists mainly used in North America.

[Data For TH-D75E]: Repeater lists mainly used in Europe.

[Data For TH-D75]: Repeater lists mainly used in Japan.

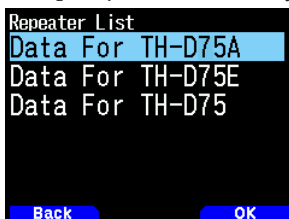

- 3 Select the region and press [A/B].
Importing begins.
- 4 Press [A/B] to restart the transceiver.

Import the Callsign list Data

- 1 Access Menu No. 813.
The Callsign list appears.

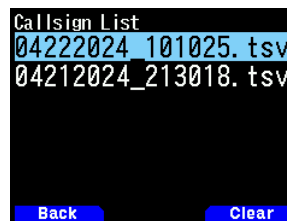

- 2 Select the file and press [ENT].
Importing begins.
- 3 Press [A/B] to restart the transceiver.

CLEARING THE SAVED FILE

Clear a saved file to a microSD memory card.

- 1 Access Menu No. 810, 811, 812, or 813.
 - Configuration data: Menu No. 810
 - Configuration data + Voice message: Menu No. 811
 - Repeater list: Menu No. 812
 - Callsign list: Menu No. 813

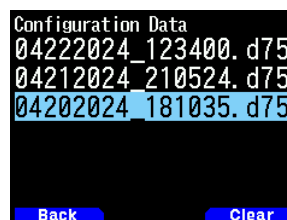

- 2 Select the file and press [A/B].
The file clear confirmation screen appears.

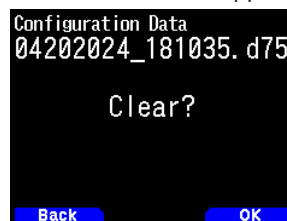

- 4 Press [A/B].
The file is cleared. When clearing is completed, the file list reappears.

COMMUNICATION HISTORY(QSO LOG)

Communication history (QSO Log) can be recorded to a microSD memory card.

- 1 Access Menu No. 180.

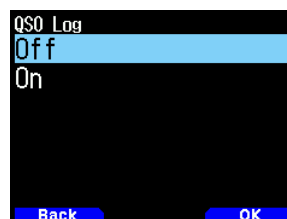

2 Select [On].

Recording begins when **PTT** is pressed.

[Off]: Does not record the communication history.

[On]: Recording the communication history.

Stored files are named as follows.

- YYYYMMDD_HHMMSS.csv

Example: 20240512_125303.CSV

(Communication history from 12:53:03 on May 12, 2024)

The following table shows the items recorded to the communication history.

Communication history items	Description
TX/RX	Transmission/reception
Date	Date (YYYY/MM/DD HH:MM)
Frequency	Frequency (xxx.xxx.xxx)
Mode	DV/FM/FM-N
My Latitude	Latitude of own station when transmission/reception (yy yy yy {N/S})
My Longitude	Longitude of own station when transmission/reception (yy yy yy {E/W})
My Altitude	Altitude of own station when transmission/reception
RF Power	RF output (S-LOW/LOW1/LOW2/MID/HIGH)
S Meter	Reception level
Caller	Own station Callsign
Memo	Memo
Called	Other party Callsign
Rx RPT1	Access repeater Callsign
Rx RPT2	Other party repeater Callsign
Message	Own station message
Repeater Control	Broadcast impossible/No response/ACK/Retransmission request/Repeater control/Auto answer
BK	Break communication
EMR	Emergency communication
Fast Data	0: Normal Data / 1: Fast Data
Latitude	Latitude of other station
Longitude	Longitude of other station
Altitude	Altitude of other station
Course	Course of other station
Speed	Speed of other station

Note:

- ◆ The saved format is TSV (tab separated text file).
- ◆ If the same file name exists, (n) is added to the end of the file name and then the file is saved.
- ◆ The communication history can not be displayed on the transceiver.
- ◆ A file of up to 2 GB can be saved per recording. If 2 GB is exceeded, the excess data will be saved as another file.
- ◆ The location information are recorded when they are acquired.

DISPLAYING THE microSD MEMORY CARD INFORMATION

1 Access Menu No. 840.

The microSD memory card information screen appears. Pressing **[MODE]** returns to the previous screen.

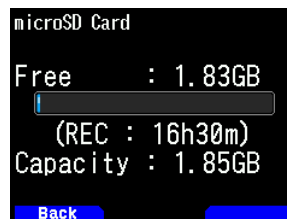

RECORDING FUNCTION

You can record communications to a microSD memory card.

- Recording is performed when transmitting and when the squelch is open. When transmission stops or the squelch closes, recording is paused.

- Up to approximately 18 hours (2 GB) can be recorded to one file. When the file being recorded exceeds 2 GB, recording continues with a new file.

- Recording files are named as follows.

Example: 04202024_132051.wav (TH-D75A)
 20042024_132051.wav (TH-D75E)
 (File for which recording started at 13:20:51 on April 20, 2024.)

- The recording audio file format is WAV.

Number of bits: 16 bits

Sampling frequency: 16 kHz

Number of channels: 1 (monaural)

- If the automatic power off (APO) time elapses during recording, recording stops and turns the power OFF.

Note:

- The transceiver only supports recording to a microSD memory card.
- A microSD memory card or microSDHC memory card is not supplied with this transceiver. Purchase a commercially available product.

RECORDING AUDIO FILES

Selecting the Recording Band

Select the recording band A or B.

- Access Menu No. 302.

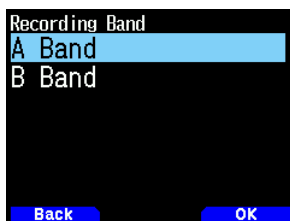

- Select [A Band] or [B Band].

[A Band]: Records the sound of the band A.

[B Band]: Records the sound of the band B.

Recording Communication Audio

Set the recording function on to start recording. Even if the recording function is on, recording will not start while the squelch is closed.

- Access Menu No. 301.

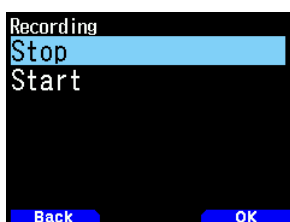

- Select [Stop] or [Start].

[Stop]: Turns off the recording function.

[Start]: Turns on the recording function.

Note:

- If there is no free space on the microSD memory card when recording starts or after recording has been started, a warning tone sounds and the insufficient microSD memory card space screen appears. Replace the microSD memory card with another one.

OPERATION OF THE AUDIO FILE

Playing Audio Files

- Access Menu No. 300.

The recording file list appears. Recorded audio files can be played and cleared.

- Select the file.

- Press [MENU].

The recording file list menu appears.



- Select [Play] and press [A/B].

Playback begins. When playback finishes, the recording file list reappears.

Note:

- When the Menu No. 301 is [Start], the recording file list does not appear.
- If there is a problem with the format of an audio file, the error screen appears and playback is not possible. Check the format of the audio file.

Key Operations in playing audio files

Key	Action
[ENT]	Pauses playback. Pressing it again resumes playback.
[MODE]	Stops playback. Pressing it again returns to the frequency screen.
[◀]	Holding down performs fast reverse playback. Releasing it resumes playback.
[▶]	Holding down performs fast forward playback. Releasing it resumes playback.
[▲]	Plays the file immediately above the file selected in the recording file list.
[▼]	Plays the file immediately below the file selected in the recording file list.

Clearing Audio Files

- 1 Access Menu No. 300.
The recording file list appears.
- 2 Select the file.
- 3 Press **[MENU]**.
The recording file list menu appears.
- 4 Select [Clear] and press **[A/B]**.
The recording file clear confirmation screen appears.



- 5 Press **[A/B]**.
The file is cleared and the recording file list reappears.

21 FM RADIO

The transceiver can receive FM radio broadcasts. You can listen to FM radio while simultaneously monitoring two signals as well as while waiting for a CQ or a call from an acquaintance, or waiting for an APRS call.

When the band A or B receives a signal (call from another party) and squelch is open, the radio sound is muted so that you can hear the other party's voice.

Note:

- ◆ You can not turn on the FM radio mode when selecting the following frequency bands in band B. (LF/MF(AMBC), HF, 50, FMBC)
- ◆ You can not turn on the FM radio mode when [priority scan] (Menu No. 134) or [WX alert] (Menu No. 105) is On, and [Detect Out Select] (Menu No. 102) is set to [IF] or [Detect].

TURNING ON FM RADIO MODE

- 1 Access Menu No. 700.

[On]: Turns on the FM radio function.

[Off]: Turns off the FM radio function.

When this is set to [On], the mode becomes FM radio mode, the frequency screen appears, and the FM radio icon  appears.

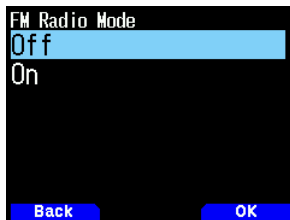

- 2 Select a frequency with **[▲]/[▼]** or **[ENC]** control.



Note:

- ◆ When you receive the signal of the band A or B while displaying the FM radio mode screen, it switches to the frequency screen or interrupt screen of the band A or B. A few seconds after reception, the screen returns to FM radio mode.
- ◆ During transmission using **[PTT]**, the screen switches to the band A/B frequency display screen. A few seconds after transmission, the screen returns to FM radio mode.
- ◆ If you want to listen to the FM radio broadcast only, it is recommended that you receive in the FM broadcast band in the single band mode of the band B.
- ◆ When FM radio mode is On, Menu No.105, 134, 200, 203, 204, 210, and 220 can not be selected.

Frequency Direct Entry (Direct Station Selection)

- 1 Press **[ENT]**.

The mode becomes frequency direct input mode.

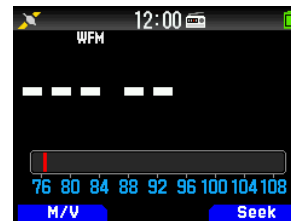

- 2 Enter a frequency using the number keys.



Radio Scan

- 1 Press **[A/B]**.

The MHz dot flashes and scanning begins. Change the scan direction with **[▲]/[▼]** or **[ENC]** control. When a broadcast station with a signal is found, scanning stops at that frequency, <<Tuned>> is displayed, and scanning ends.



- 2 Press **[A/B]**, and Radio scan stops.

EDITING THE FM RADIO MEMORY CHANNEL LIST

FM broadcast stations for up to ten channels can be registered to the FM radio memory channel list. You can assign names and edit the registered broadcast stations.

Registering FM Radio Stations

Register the FM radio stations you listen to frequently to FM radio memory channels.

- 1 Switch to FM radio mode and select a broadcast station you wish to register.

- 2 Press **[F]**, **[MR]**.

The store in the FM radio memory channel screen appears.



- Select the channel and press [ENT].
The FM radio station is registered and the FM radio memory channel list appears.

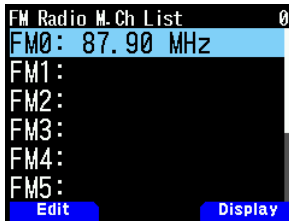

- Press [◀].
The frequency screen reappears.

Selecting a FM Radio Station

Select a registered FM radio station from the FM radio memory channel list.

- Access Menu No. 710.
The FM radio memory channel list appears.

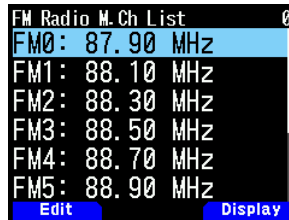

- Select the channel and press [ENT].
Select from FM0 to FM9.

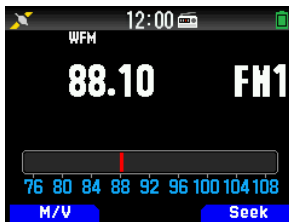

Note:

- Menu No. 710 can be accessed when FM radio mode is On.

Clearing FM Radio Stations

Clear the FM radio stations you do not listen to any more from the FM radio memory channels.

- Access Menu No. 710.
The FM radio memory channel list appears.
- Select the channel you wish to clear.
Select from FM0 to FM9.
- Press [MENU].
The FM radio memory channel list menu appears.



- Select [Clear Memory] and press [A/B].
The FM radio memory clear confirmation screen appears.

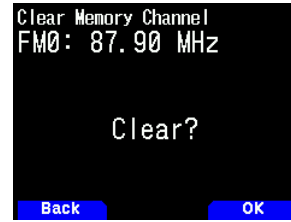

- Press [A/B].
The FM radio station is cleared, and the FM radio memory channel list menu reappears.

Switching Between FM Radio Mode and FM Radio Memory Mode

FM radio mode

This mode allows you to receive an FM radio broadcast by setting a frequency.

FM radio memory mode

This mode allows you to call up memory channels for which frequencies have been registered in advance. A channel indication from FM0 to FM9 is displayed in FM radio memory mode.

- Press [MODE].
Each press switches between FM radio mode and FM radio memory mode.



FM radio mode

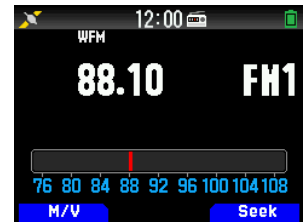

FM radio memory mode

Note:

- When no broadcast stations are registered in FM radio memory channel list, you can not switch to the FM radio memory mode.

Key Operations in FM Radio and FM Radio Memory Mode

Key Name	Operation
[◀]	Pauses FM radio mode, and return to FM radio mode after a few seconds.
	Switches to [GPS satellite information] screen when the GPS operation mode is GPS Receiver mode.
[▶]	Pauses FM radio mode, and return to FM radio mode after a few seconds.
	Switches to [time, Altitude, Heading, and Speed] screen when the GPS operation mode is GPS Receiver mode.
[ENT]	Switches to frequency direct input mode. (in FM radio mode)
	Displays the FM radio memory channel list. (in FM radio memory mode)
[MODE]	Switches between FM radio mode and FM radio memory mode.
[A/B]	Performs a radio scan (Seek).
Keypad	Pauses FM radio mode, and return to FM radio mode after a few seconds.

Memory Shift

Copy the frequency of a broadcast station from the FM radio memory channel list to VF0.

- 1 Access Menu No. 710.

The FM radio memory channel list appears.

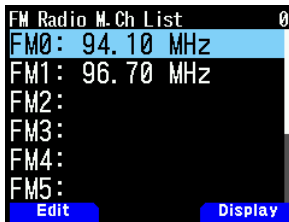

- 2 Select the Channel.
Select from FM0 to FM9.

- 3 Press [MENU].

The FM radio memory channel list menu appears.



- 4 Select [Memory Shift (M>V)] and press [A/B].

The frequency of the selected channel is copied to VF0, and the frequency screen reappears.

Naming to Broadcast Stations

Assign names to the broadcast stations registered to FM radio memory channels.

- 1 Access Menu No. 710.

The FM radio memory channel list appears.

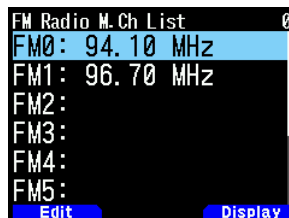

- 2 Select the channel to assign a name.
Select from FM0 to FM9.

- 3 Press [MODE].

The FM radio memory channel list menu appears.

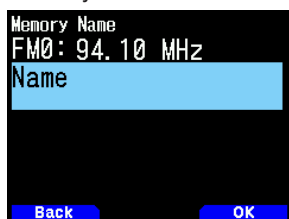

- 4 Press [A/B].

The memory name setting screen appears.



- 5 Enter characters.



- 6 Press [ENT].

The broadcast station name is registered.



- 7 Press [MODE] or [MENU].

Press [MODE] to return to the FM radio memory channel list screen, and press [MENU] to return to the frequency screen.

Note:

- ◆ Deleting the FM radio memory channel also deletes the memory name.

Switching the Display of Broadcast Stations

- 1 Access Menu No. 710.

The FM radio memory channel list appears.

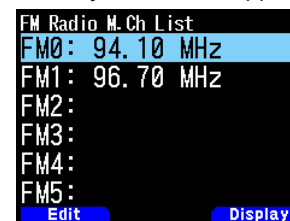

- 2 Press [A/B].

Each press switches between the frequency and memory name display.

FM Radio Auto Mute Return Time

When a signal is received or transmitted in band A or B while listening to a radio broadcast in FM radio mode, the reception sound of the radio broadcast is muted. When a signal is no longer received in band A or B or after transmission is completed, the transceiver automatically returns to FM radio mode after a period of time has lapsed without any operation being performed. This period of time can be changed.

After transmission is completed in band A or B, if you are concerned about the switching of display or sound by signals from the break station, lengthen the setting time.

- 1 Access Menu No. 701.

- 2 Select the time from [1] to [10] seconds.



Note:

- ◆ When an APRS or D-STAR interrupt screen is displayed in FM radio mode, the screen switches to the interrupt screen.

22 VOICE MESSAGE MEMORY

The transceiver can record and transmit voice messages in up to 4 channels. This is a convenient function when transmitting fixed voice messages.

Note

- ◆ Recording is possible for 30 seconds only with channel 1. Recording is possible for 15 seconds with channels 2 to 4.
- ◆ Recording is also possible from an external microphone and Bluetooth headset in addition to the built-in microphone.
- ◆ The transceiver only supports recording a voice message to the internal memory. Recording to a microSD card is not supported.

RECORDING VOICE MESSAGES

Record the voice from the microphone to the voice message memory channels.

- 1 Access Menu No. 310.

The voice message list appears.

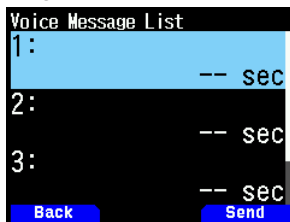

- 2 Select the channel to record.

Select [1] (Ch), [2] (Ch), [3] (Ch), or [4] (Ch). Recording is possible for 30 seconds only with channel 1. Recording is possible for 15 seconds with the other channels.

- 3 Press [MENU].

The voice message list menu appears.

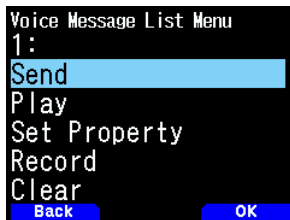

- 4 Select [Record] and press [A/B].

The recording waiting screen appears.

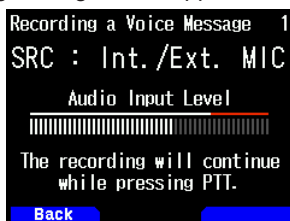

- 5 Speak into the microphone while pressing [PTT].

Recording the voice while pressing [PTT].



- 6 Release [PTT].

Recording stops and the voice message is written.

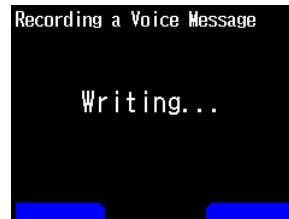

- When writing completes, the writing completed screen appears.



- 7 Press [A/B].

The voice message list menu reappears.

Voice Messages Playback

Playing a recorded voice message to check the message.

- 1 Access Menu No. 310.

The voice message list appears.

- 2 Select the channel to play.

Select [1] (Ch), [2] (Ch), [3] (Ch), or [4] (Ch).

- 3 Press [MENU].

The voice message list menu appears.

- 4 Select [Play] and press [A/B].

Playback starts. Pressing [PTT] stops playback and returns to the frequency screen. When playback finishes, the voice message list reappears.

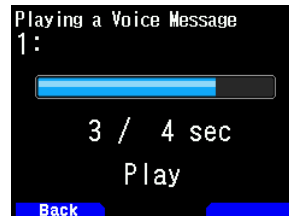

SENDING VOICE MESSAGES

Send the message of a recorded voice message channel.

- 1 Access Menu No. 310.
The voice message list appears.
- 2 Select the channel to send.
- 3 Press **[A/B]**.
Playing and sending begins. Pressing **[PTT]** stops playback and returns to the frequency screen. When playing and sending finishes, the frequency screen reappears.

Repeat Playback

This function is for playing and sending the voice message of one channel repeatedly. It is convenient for repeating a CQ during, for example, a contest.

- 1 Access Menu No. 310.
The voice message list appears.
- 2 Select the channel to repeat.
- 3 Press **[MENU]**.
The voice message list menu appears.



- 4 Select **[Set Property]** and press **[A/B]**.
The voice message memory setting screen appears.

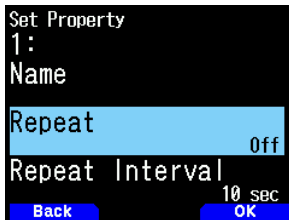

- 5 Select **[Repeat]** and press **[A/B]**.

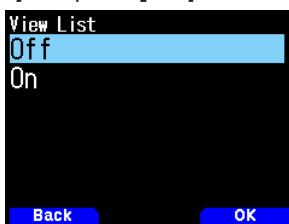

- 6 Select **[Off]** or **[On]**.
[Off]: Turns off the repeat playback function.
[On]: Turns on the repeat playback function.
- 7 Press **[A/B]**.
Repeat playback is set.

Repeat Playback Interval

Set the repeat playback interval for playing and sending repeatedly.

- 1 Access Menu No. 310.
The voice message list appears.
- 2 Select the channel to change interval.
- 3 Press **[MENU]**.
The voice message list menu appears.
- 4 Select **[Set Property]** and press **[A/B]**.
The voice message memory editing screen appears.
- 5 Select **[Repeat Interval]** and press **[A/B]**.



- 6 Select from **[0]** to **[60]** seconds.
- 7 Press **[A/B]**.
The repeat playback interval is set.

VOICE MESSAGE MEMORY NAMES

This function is for assigning names to voice message memory channels.

- 1 Access Menu No. 310.
The voice message list appears.
- 2 Select the channel to assign names.
- 3 Press **[MENU]**.
The voice message list menu appears.
- 4 Select **[Set Property]** and press **[A/B]**.
The voice message memory setting screen appears.

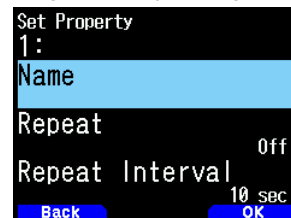

- 5 Select **[Name]** and press **[A/B]**.
The name input screen appears.



- 6 Enter the name and press **[ENT]**.
The name is registered.

CLEARING VOICE MESSAGES

- 1 Access Menu No. 310.
The voice message list appears.
- 2 Select the channel to clear.
- 3 Press **[MENU]**.
The voice message list menu appears.

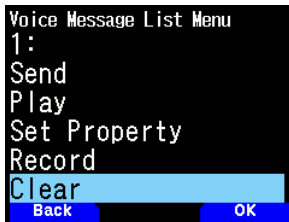

- 4 Select **[Clear]** and press **[A/B]**.
The voice message clear confirmation screen appears.

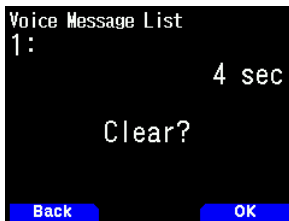

- 5 Press **[A/B]**.
The voice message is cleared. The voice message list reappears.

TX MONITORING OF VOICE MESSAGE

This function is for monitoring the voice message that is play when playing and sending a voice message.

- 1 Access Menu No. 311.

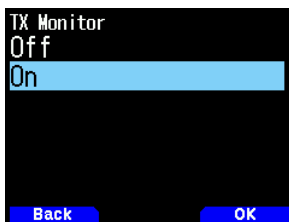

- 2 Select **[Off]** or **[On]**.
[Off]: Turns off the TX Monitor function.
[On]: Turns on the TX Monitor function.

23 VOICE GUIDANCE

Voice guidance is a function that provides audio information about operating conditions such as the frequency displayed on the display, memory channels, and function settings.

SETTING VOICE GUIDANCE MODE

- 1 Access Menu No. 916.

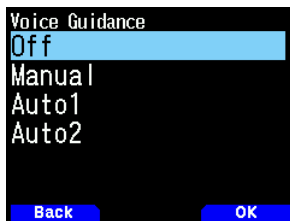

- 2 Select [Off], [Manual], [Auto1], or [Auto2].
[Off]: Turn off the voice guidance function.
[Manual]: Reads out the current status when pressing [⏏].
[Auto1]: Reads out the status or displayed information changed by the operation.
[Auto2]: It reads out the changed status and display contents as you operate. When reading out a memory channel, if a memory name is registered, the memory name (only characters that can be spoken) will be read out instead of the frequency.

Note:

- ◆ The voice guidance language is English only. This is in accordance with the display contents when menu No. 990 is set to "English".
- ◆ In order to make it easier to hear, the displayed content and the readout content may be different in some parts.
- ◆ If you press [PF2] + Power ON when the transceiver power is OFF, the transceiver power turns ON and the voice guidance is set to [Auto1].
- ◆ If you want to listen to the reading again using [Auto 1] or [Auto 2], press [⏏] briefly to read out the current status.
- ◆ While the voice guidance is being read out, the reception sound is not output.

Voice Guidance Volume

This function is to set the volume level of the voice guidance. The volume level can be changed by VOL Link (Linked with [VOL] control.), or set by a value among "Level 1" to "Level 7". A larger value results in a greater volume. The default is [VOL Link].

- 1 Access Menu No. 917.
- 2 Select [VOL Link] or [Level 1] - [Level 7].

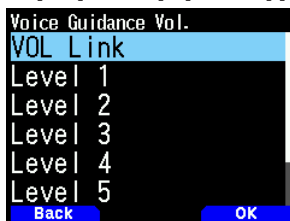

- 3 Press [A/B].
The volume level set.

Voice Guidance Speed

Set the voice guidance reading out speed. The default is [Speed 1].

- 1 Access Menu No. 918.

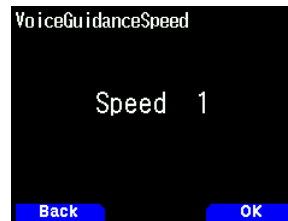

- 2 Set the guidance speed level from 1 to 4.
The speed level set.
Speed 1: Normal speed
Speed 2: 1.15 times normal speed
Speed 3: 1.30 times normal speed
Speed 4: 1.45 times normal speed
The higher the number, the faster the speed.

Callsign Readout method

Specifies how to pronounce the alphabetic characters (A-Z) in the callsign.

- 1 Access Menu No. 919.

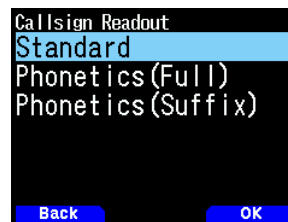

- 2 Select [Standard], [Full Phonetics], or [Suffix Phonetics].
[Standard]:
Read out the alphabet as it is.
[Phonetics (Full)]:
All are read out in phonetic code.
[Phonetics (Suffix)]:
Only the suffix is read out in phonetic code.

APRS Voice

This function reads out the sender's callsign and content when receiving an APRS message addressed to your station.

- 1 Access Menu No. 575.

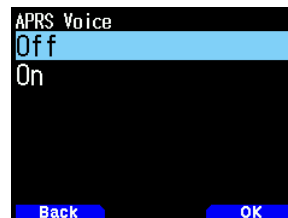

- 2 Select [Off] or [On].
[Off]:
Turn OFF the APRS Voice function.
[On]:
Turns ON the APRS Voice function.

Note:

- ◆ The APRS Voice (menu No. 575) operates regardless of the Voice Guidance mode setting (menu No. 916).

Callsign Announce

This function is to announce the Callsign when a D-STAR signal is received. It enables you to know the Callsign without looking at the screen.

- 1 Access Menu No. 644.
 - Please refer to page No.16-12 "CALLSIGN ANNOUNCE" for details.



Note:

- ◆ When [Kerchunk], [My Station], or [All] is selected, the transceiver will announce the current accessibility of the D-STAR repeater as a response to the Kerchunk.
 - ◆ The transceiver announces the results of the kerchunk as follows.
 - "Not available to access the repeater."
 - Error
 - "Available to access the repeater."
 - Operational
 - ◆ The Callsign Announce (menu No.644) operates regardless of the Voice Guidance mode setting (menu No. 916).
-

24 WEATHER ALERT (TH-D75A ONLY)



The Weather Alert is available only in the USA and Canada. When activated, this function will check for a received NOAA 1050 Hz tone. When the tone is received, the weather alert tone will sound.

WEATHER ALERT ON/ OFF

The transceiver stops scanning at a frequency or memory channel on which a signal is detected. It then continues scanning according to which resume mode you have selected. You can choose one of the following modes.

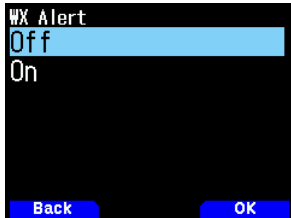
- 1 Access Menu No. 105.



- 2 Set the Weather Alert to [On] or [Off].
 - When activated, the <  > icon appears on the display.
 - When a signal is being received, the <  > icon blinks.

Note:

- ◆ This function can not be set to On when the priority scan or FM radio mode is On.

Weather Channel

Whether or not the Weather Alert is activated, you can still access the weather channels. The Weather Alert simply notifies you of activity on the weather channels.

- 1 Press [MR] to switch to the memory mode.
- 2 Press and hold [◀]/[▶] to select the memory channel group "Weather".
- 3 Press [▲]/[▼] or rotate the [ENC] control to select your desired channel.

Channel No.	Frequency (MHz)	Memory Name	Location
A1	162.550	WX 1	NOAA/ Canada
A2	162.400	WX 2	NOAA/ Canada
A3	162.475	WX 3	NOAA/ Canada
A4	162.425	WX 4	NOAA
A5	162.450	WX 5	NOAA
A6	162.500	WX 6	NOAA
A7	162.525	WX 7	NOAA
A8	161.650	WX 8	Canada
A9	161.775	WX 9	Canada
A10	163.275	WX 10	-

WEATHER CHANNEL SCAN

The memory channel only for the weather alert is scanned.

- 1 Access Menu No. 136.

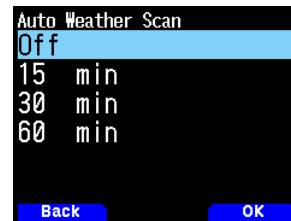

- 2 Set the Weather Alert Scan to [Off], [15], [30], or [60] minutes.

When the weather channel scanning time is set:

Auto scanning starts after the set time.

When the weather channel scanning is set to Off:

After selecting the memory channel group "Weather", press and hold [MR] to start the weather channel scan.

- When selecting the memory channel group "All Groups", the weather channel scan does not work.
- Scanning stops when the channel with the highest signal level is received or no signal is received in all scanned channels.
- Memory scanning stops when performing any operation other than [MONI], [key lock] (press and hold [F]), [▲]/[▼], and [ENC] control.

25 WIRELESS CONTROL (TH-D75A ONLY)

If you also have a **KENWOOD** multi-band mobile transceiver, you can control one of its bands by sending DTMF tones from this handy transceiver. You will find this function useful when you want to control your mobile transceiver from a location outside your vehicle.

Note:

- ◆ You can remotely control only mobile transceivers that have both the secret number and Remote Control functions.
- ◆ FCC rules permit you to send control codes only on the 440 MHz band.

PREPARATION

Let us assume the VHF band of the mobile transceiver will be controlled.

On the TH-D75A:

- 1 Access Menu No. 946.

The current secret access code number appears.



- 2 To change the secret number, press the numeric keys (0 to 9) to enter a 3-digit number.

On the mobile transceiver:

- 1 Set the ID code to the same secret number you set on the handy transceiver.
 - For the method, refer to the instruction manual for the mobile transceiver.
- 2 Select the receive frequency on the UHF band.
 - Match this frequency with the transmit frequency of the handy transceiver.
- 3 Enter the transceiver's Remote Control mode.
 - For the method, refer to the instruction manual for the mobile transceiver. If it is not described, consult your authorized **KENWOOD** dealer, customer service, or service center.

CONTROL OPERATION

- 1 Press and hold [PTT].
- 2 While transmitting, press [ENT].
 - The last called DTMF Memory channel number.
- 3 While still transmitting, press [▲]/[▼] or rotate the [ENC] control to select your desired remote control number (RM0 ~ RM#), then press [ENT] to transmit DTMF code.

Note:

- ◆ If using a handheld without a remote control function, manually send "AXXX#YA#" where "XXX" is a 3-digit secret number and "Y" is a single-digit control command. If you do not add "A#" to the end, you can skip sending "AXXX#" next time; however, the mobile may be accidentally controlled by other stations.

Remote control number	Memory name	Operation
RM0	LOW	Transmit power (ex. press to toggle between High, Medium, and Low)
RM1	On	DCS ON (TM-D710/G, TS-2000) Revers ON (TM-V7, TM-D700) Tone Alert ON (other models)
RM2	TONE On	Tone ON
RM3	CTCSS On	CTCSS ON
RM4	Off	DCS OFF (TM-D710/G, TS-2000) Revers OFF (TM-V7, TM-D700) Tone Alert OFF (other models)
RM5	TONE Off	Tone OFF
RM6	CTCSS Off	CTCSS OFF
RM7	CALL	Call mode ON
RM8	VFO	VFO mode ON
RM9	MR	Memory mode ON
RMA	Freq. Enter	Frequency (in VFO mode) or Memory channel (in Memory mode) direct entry
RMB	Tone Select	DCS code (when DCS is ON), Tone frequency (when Tone is ON), or CTCSS frequency (when CTCSS is ON) setup
RMC	REPEATER On	Repeater (Cross-band or Locked-band) ON
RMD	REPEATER Off	Repeater OFF
RM*	DOWN	Step the frequency or Memory channel down
RM#	UP	Step the frequency or Memory channel up

26 OPTIONS

The following options are available for use with this transceiver.

Model Name	Name
KNB-75LA	Li-ion Battery Pack(STD, 7.4 V, 1820 mAh)
KSC-25LS	Rapid Charger
KBP-9	Battery Case
KMC-45D	Speaker Microphone
EMC-11	Clip Microphone with Earphone
EMC-12	Clip Microphone with Earphone
EMC-3A	Clip Microphone with Earphone
HMC-3	Headset with VOX
KHS-21	Headset
KHS-35F	Headset
PG-2W	DC Cable
PG-3J	Cigarette Lighter Cord with Noise Filter
MCP-D75	Memory Control Program
ARFC-D75	Frequency Control Program

Note:

- ◆ Optional accessories for use with this transceiver may change, post-production. (New options may become available and/or current options may be discontinued.) Please refer to the options catalog(s) for applicable transceivers.

27 MAINTENANCE

GENERAL INFORMATION

This product has been factory aligned and tested to specification before shipment. Attempting service or alignment without factory authorization can void the product warranty.

SERVICE

When returning this product to your dealer or service center for repair, pack it in its original box and packing material. Include a full description of the problem(s) experienced. Include your telephone number along with your name and address in case the service technician needs to contact you; if available, also include your fax number and e-mail address. Don't return accessory items unless you feel they are directly related to the service problem.

You may return this product for service to the authorized **KENWOOD** dealer from whom you purchased it, or any authorized **KENWOOD** service center. Please do not send subassemblies or printed circuit boards; send the complete product. A copy of the service report will be returned with the product.

SERVICE NOTE

If you desire to correspond on a technical or operational problem, please make your note legible, short, complete, and to the point. Help us help you by providing the following:

- Model and serial number of equipment
- Question or problem you are having
- Other equipment in your station pertaining to the problem



CAUTION

- Do not pack the equipment in crushed newspapers for shipment! Extensive damage may result during rough handling or shipping.

Note:

- ◆ Record the date of purchase, serial number and dealer from whom this product was purchased.
- ◆ For your own information, retain a written record of any maintenance performed on this product.
- ◆ When claiming warranty service, please include a photocopy of the bill of sale or other proof-of-purchase showing the date of sale.



CLEANING

To clean the case of this product, use a neutral detergent (no strong chemicals) and a damp cloth.

TROUBLESHOOTING

The problems described in this table are commonly encountered operational malfunctions and are usually not caused by circuit failure.

Problem	Probable Cause	Corrective Action
Power is not turned on when using Li-ion battery pack or AAA alkaline batteries.	Battery voltage is low.	Recharge the battery pack or replace the AAA alkaline batteries with new ones.
	The protective circuit of the Li-ion battery is functioning.	Remove the Li-ion battery from the transceiver, reinstall, then turn on the power again.
	When both DC IN and the battery are connected, turning off the power of DC IN may restart the transceiver.	This is not a malfunction. You can use the transceiver after restart.
Power is not turned on when using regulated DC power supply or cigarette lighter socket.	Faulty power cable or bad connection.	Check for any abnormality in the cable and whether the polarity is correct.
	Power cable fuse has blown out.	If the fuse has blown out due to reasons other than the transceiver, replace the fuse after repair.
Power is turned on but nothing appears on the display.	Automatic Power Off (APO) is functioning.	Turn OFF the power supply, then turn it ON again.
	The power supply may be turned OFF during transmission when the charger and battery are used at the same time.	The charger is used for charging purpose. The process of turning OFF the power supply and restarting the transceiver is not a malfunction. A regulated DC power supply can be used together with the battery without having to restart the transceiver.
No sound from the speaker even though the volume is turned up.	The sound has been set to mute at Volume Balance.	Set other volume except for mute.
	The squelch is closed.	Lower the threshold level of the squelch (toward 0).
	CTCSS is set to ON.	Set CTCSS to OFF.
	DCS is set to ON.	Set DCS to OFF.
	The transceiver is paired with a Bluetooth headset.	Disconnect the Bluetooth headset.
Unable to adjust to a higher (or lower) frequency even by rotating the [ENC] control.	Programmable VFO has been configured.	Reconfigure the frequency of the programmable VFO.
The frequency does not change even by rotating the [ENC] control.	Key Lock has been set.	Change the type of Key Lock or cancel Key Lock.
Pressing [MR] does not display the memory channels.	Nothing is registered in the memory channels.	Register data in the memory channels.
Memory cannot be recalled.	The recall method of the memory channel has been set to [Current Band] and the frequency of the displayed frequency band has not been registered in the memory channel.	Change recall method of the memory channel to [All Bands], or register data in the memory channel.
Unable to transmit.	TX Inhibit has been activated.	Set TX Inhibit to OFF.
	Transmission frequency is out of range.	Change the frequency to within the transmission range and transmit.
The display is blinking on and off during transmission.	Power voltage is low.	Recharge the battery pack or replace the AAA alkaline batteries with new ones.
Transmission output decreases. Or "H" (high power) is blinking.	Temperature protection is activated and output is automatically decreased.	Turn OFF the power supply or remain in the receiving state and wait until the temperature decreases.
Repeater cannot be used.	Auto Repeater Offset is set to OFF.	Set Auto Repeater Offset to ON.
	Wrong tone frequency/shift/offset width.	Select a proper tone frequency/shift/offset width.
Reverse cannot be set to OFF.	As Shift is set to ON, setting Reverse to OFF will set the frequency outside the allowable frequency band.	Set Shift to OFF, then set Reverse to OFF.
The Scan function stops immediately.	The threshold level of squelch is Open.	Adjust the threshold level to an appropriate level.
The Scan function does not resume scanning after it has stopped.	Scan resume method is set to Seek.	Set to Time (Time-Operated) or Carrier (Carrier-Operated).
Most keys do not function.	Key Lock has been set.	Cancel Key Lock.
VOX does not function.	VOX gain settings are too low.	Adjust the VOX gain.
The speaker sound is transmitted.	The headset with VOX function is not connected.	Connect the headset with VOX function, and then set VOX to ON.
	VOX is ON and headset is not connected.	

Problem	Probable Cause	Corrective Action
Received signals are not properly demodulated.	Wrong settings for signal format (Demodulation mode).	Try changing to other modes.
	When receiving sound is distorted in AM/SSB/CW, the receiving signal is too strong.	Set the ATT function to ON.
The display darkens.	The temperature of the transceiver is rising.	Turn OFF the power supply or remain in the receiving state and place the transceiver in a cool place.
Difficult for the built-in GPS receiver to receive signals depending on the frequency of the transceiver.	The local circuit of the transceiver is affecting the GPS sensitivity.	Change the frequency in band A/band B, or change the frequency in use.
The battery icon does not show that it is being charged. When charging during power OFF, nothing is displayed on the screen.	The transceiver is being charged at the charging station.	The battery icon does not show that it is being charged when charging the transceiver at the charging station. Nothing is displayed on the screen when charging at the charging station during power OFF. In this case, check the LED of the charging station for the status.
Unable to connect to Bluetooth device.	The transceiver is not paired with the Bluetooth device (headset etc.).	Search for the Bluetooth device and connect when found.
Bluetooth device is not found after searching	The Bluetooth device (headset etc.) is not ready.	Wait for the Bluetooth device to be ready before searching.
Unable to communicate via virtual COM port even though the transceiver is connected to a PC via a USB cable.	The USB selection setting is set to "Mass Storage".	Set the USB selection setting to "COM+AF/IF Output".
No sound from the PC even though the transceiver is connected to a PC via a USB cable.	The USB selection setting is set to "Mass Storage".	Set the USB selection setting to "COM+AF/IF Output". If you still cannot hear anything, check the PC settings.
The transceiver is not displayed as a removable disk even though it is connected to a PC via a USB cable.	The USB selection setting is set to "COM+AF/IF Output".	Set the USB selection setting to "Mass Storage".
Data saved on the microSD memory card cannot be read.	Data format is not supported.	Use a microSD memory card that was formatted on the transceiver.
The voice of receiving party is cut off or distorted during transmission in DV/DR mode.	Bad propagation.	Move to a location with good propagation. If the reception still does not improve, it could be due to bad propagation between the other station and the access repeaters of the other station. Inform the other station and ask them to adjust the output, or have them move to a location with good propagation.
QSO is possible with Stand Alone in DV/ DR mode but not possible with Over the Gateway or specific stations.	The Callsign of own station is not registered in the D-STAR management server.	Register the Callsign in the D-STAR management server.
	Gateway is not functioning.	Check with the management organization of the repeater.
Packet loss icon  lights up and voice is cut off during transmission in DV/ DR mode.	• The transceiver is receiving packet loss, indicating loss of partial data during communication via Internet network.	Wait for a while and call again. The transceiver may mistake the receiving of packet loss with garbled data. In that case, icon  display will light up on the display even in local area call.
FM display is blinking in DV mode.	The transceiver is receiving signals in FM mode.	Wait for a while and call again.
No message is returned from the repeater after transmission in DR mode (S-meter also does not move).	The access repeater selection is incorrect.	Set the correct access repeater to "FROM".
	The manually entered repeater frequency is incorrect (or shift setting is incorrect).	Set the repeater frequency (or shift setting) correctly.
	Outside the repeater area (or signals are not reaching the repeater).	Move to a location where the signal reaches the repeater. Or, access another repeater where the signal reaches.
The broadcast impossible icon appears after transmission in DR mode (Voice guidance indicates error).	The destination repeater cannot be reached, or it is in use.	Wait for a while and call again
	The destination repeater Callsign is incorrect.	Set the correct repeater Callsign.
Unable to connect to reflector in DR mode.	The access repeater does not support reflector.	Check with the management organization of the repeater.
Unable to transmit using PTT in DV/ DR mode.	The transceiver is in data communication mode.	Cancel data communication mode and transmit using [PTT] .
Transmission does not end immediately even after [PTT] is released in DV/ DR mode.	"GPS Info. in Frame" is set to On.	If it is not necessary, set "GPS Info. in Frame" to Off.

28 SPECIFICATIONS

TH-D75A/ TH-D75E SPECIFICATIONS

GENERAL																																									
Frequency Range	<table border="0"> <tr> <td>Band A</td> <td>TX: 144 - 148 (TH-D75A), 144 - 146 (TH-D75E), 222 - 225 (TH-D75A), 430 - 450 (TH-D75A), 430 - 440 (TH-D75E) MHz</td> </tr> <tr> <td></td> <td>RX: 136 - 174, 216 - 260 (TH-D75A only), 410 - 470 MHz</td> </tr> <tr> <td>Band B</td> <td>TX: 144 - 148 (TH-D75A), 144 - 146 (TH-D75E), 222 - 225 (TH-D75A), 430 - 450 (TH-D75A), 430 - 440 (TH-D75E) MHz</td> </tr> <tr> <td></td> <td>RX: 0.1 - 76, 76 - 108 MHz (WFM) 108 - 524 MHz</td> </tr> </table>	Band A	TX: 144 - 148 (TH-D75A), 144 - 146 (TH-D75E), 222 - 225 (TH-D75A), 430 - 450 (TH-D75A), 430 - 440 (TH-D75E) MHz		RX: 136 - 174, 216 - 260 (TH-D75A only), 410 - 470 MHz	Band B	TX: 144 - 148 (TH-D75A), 144 - 146 (TH-D75E), 222 - 225 (TH-D75A), 430 - 450 (TH-D75A), 430 - 440 (TH-D75E) MHz		RX: 0.1 - 76, 76 - 108 MHz (WFM) 108 - 524 MHz																																
Band A	TX: 144 - 148 (TH-D75A), 144 - 146 (TH-D75E), 222 - 225 (TH-D75A), 430 - 450 (TH-D75A), 430 - 440 (TH-D75E) MHz																																								
	RX: 136 - 174, 216 - 260 (TH-D75A only), 410 - 470 MHz																																								
Band B	TX: 144 - 148 (TH-D75A), 144 - 146 (TH-D75E), 222 - 225 (TH-D75A), 430 - 450 (TH-D75A), 430 - 440 (TH-D75E) MHz																																								
	RX: 0.1 - 76, 76 - 108 MHz (WFM) 108 - 524 MHz																																								
Mode	<table border="0"> <tr> <td>TX</td> <td>F1D, F2D, F3E, F7W</td> </tr> <tr> <td>RX</td> <td>F1D, F2D, F3E, F7W, A1A, A3E, J3E</td> </tr> </table>	TX	F1D, F2D, F3E, F7W	RX	F1D, F2D, F3E, F7W, A1A, A3E, J3E																																				
TX	F1D, F2D, F3E, F7W																																								
RX	F1D, F2D, F3E, F7W, A1A, A3E, J3E																																								
Operating Temp. Range	-20 °C ~ +60 °C (-4 °F ~ +140 °F) with Incd. KNB-75LA -10 °C ~ +50 °C (+14 °F ~ +122 °F)																																								
Frequency Stability	±2.0 ppm																																								
Antenna Impedance	50 Ω																																								
Operating Voltage	<table border="0"> <tr> <td>DC IN</td> <td>DC 11.0 - 15.9 V (STD: DC 13.8 V)</td> </tr> <tr> <td>BATT</td> <td>DC 6.0 - 9.6 V (STD: DC 7.4 V)</td> </tr> </table>	DC IN	DC 11.0 - 15.9 V (STD: DC 13.8 V)	BATT	DC 6.0 - 9.6 V (STD: DC 7.4 V)																																				
DC IN	DC 11.0 - 15.9 V (STD: DC 13.8 V)																																								
BATT	DC 6.0 - 9.6 V (STD: DC 7.4 V)																																								
Current Consumption (TYP.)	<table border="0"> <tr> <td>TX</td> <td colspan="4">EXT.PS 13.8 V / Battery:7.4 V</td> </tr> <tr> <td></td> <td>H</td> <td>M</td> <td>L</td> <td>EL</td> </tr> <tr> <td>DC IN</td> <td>1.4 A</td> <td>0.9 A</td> <td>0.6 A</td> <td>0.4 A</td> </tr> <tr> <td>BATT</td> <td>2.0 A</td> <td>1.3 A</td> <td>0.8 A</td> <td>0.5 A</td> </tr> </table>	TX	EXT.PS 13.8 V / Battery:7.4 V					H	M	L	EL	DC IN	1.4 A	0.9 A	0.6 A	0.4 A	BATT	2.0 A	1.3 A	0.8 A	0.5 A																				
TX	EXT.PS 13.8 V / Battery:7.4 V																																								
	H	M	L	EL																																					
DC IN	1.4 A	0.9 A	0.6 A	0.4 A																																					
BATT	2.0 A	1.3 A	0.8 A	0.5 A																																					
Current Consumption (TYP.)	<table border="0"> <tr> <td>RX</td> <td colspan="4"></td> </tr> <tr> <td>SINGLE</td> <td>260 mA</td> <td>(Rated Power)</td> <td></td> <td></td> </tr> <tr> <td></td> <td>155 mA</td> <td>(SQ Close)</td> <td></td> <td></td> </tr> <tr> <td></td> <td>50 mA</td> <td>(Avg. Save on)</td> <td></td> <td></td> </tr> <tr> <td>DUAL</td> <td>310 mA</td> <td>(Rated Power)</td> <td></td> <td></td> </tr> <tr> <td></td> <td>225 mA</td> <td>(SQ Close)</td> <td></td> <td></td> </tr> <tr> <td></td> <td>50 mA</td> <td>(Avg. Save on)</td> <td></td> <td></td> </tr> <tr> <td>GPS logger mode</td> <td>125 mA</td> <td></td> <td></td> <td></td> </tr> </table>	RX					SINGLE	260 mA	(Rated Power)				155 mA	(SQ Close)				50 mA	(Avg. Save on)			DUAL	310 mA	(Rated Power)				225 mA	(SQ Close)				50 mA	(Avg. Save on)			GPS logger mode	125 mA			
RX																																									
SINGLE	260 mA	(Rated Power)																																							
	155 mA	(SQ Close)																																							
	50 mA	(Avg. Save on)																																							
DUAL	310 mA	(Rated Power)																																							
	225 mA	(SQ Close)																																							
	50 mA	(Avg. Save on)																																							
GPS logger mode	125 mA																																								
Battery Life	<table border="0"> <tr> <td>Approx.</td> <td colspan="4">Single, Save on, Rate 6:6:48 sec, GPS off</td> </tr> <tr> <td></td> <td>H</td> <td>M</td> <td>L</td> <td>EL</td> </tr> <tr> <td>KNB-75LA (1,820 mAh)</td> <td>6 hours</td> <td>8 hours</td> <td>12 hours</td> <td>15 hours</td> </tr> <tr> <td>KBP-9 (Alkaline AAx6)</td> <td>-----</td> <td>-----</td> <td>3.5 hours</td> <td>-----</td> </tr> <tr> <td></td> <td colspan="4">Approx. 10 % shorter when GPS is ON</td> </tr> </table>	Approx.	Single, Save on, Rate 6:6:48 sec, GPS off					H	M	L	EL	KNB-75LA (1,820 mAh)	6 hours	8 hours	12 hours	15 hours	KBP-9 (Alkaline AAx6)	-----	-----	3.5 hours	-----		Approx. 10 % shorter when GPS is ON																		
Approx.	Single, Save on, Rate 6:6:48 sec, GPS off																																								
	H	M	L	EL																																					
KNB-75LA (1,820 mAh)	6 hours	8 hours	12 hours	15 hours																																					
KBP-9 (Alkaline AAx6)	-----	-----	3.5 hours	-----																																					
	Approx. 10 % shorter when GPS is ON																																								
Dimensions (W x H x D)	<table border="0"> <tr> <td></td> <td colspan="4">Projections not included</td> </tr> <tr> <td>with KNB-75LA</td> <td colspan="4">56.0 x 121.95 x 32.5 mm (2.20 x 4.80 x 1.28 inch)</td> </tr> <tr> <td>with KBP-9</td> <td colspan="4">56.0 x 121.95 x 34.6 mm (2.20 x 4.80 x 1.36 inch)</td> </tr> </table>		Projections not included				with KNB-75LA	56.0 x 121.95 x 32.5 mm (2.20 x 4.80 x 1.28 inch)				with KBP-9	56.0 x 121.95 x 34.6 mm (2.20 x 4.80 x 1.36 inch)																												
	Projections not included																																								
with KNB-75LA	56.0 x 121.95 x 32.5 mm (2.20 x 4.80 x 1.28 inch)																																								
with KBP-9	56.0 x 121.95 x 34.6 mm (2.20 x 4.80 x 1.36 inch)																																								
Weight (net)	<table border="0"> <tr> <td>Body only</td> <td colspan="4">TH-D75A: 204 g (7.20 oz)/ TH-D75E: 203 g (7.16 oz)</td> </tr> <tr> <td>with KNB-75LA</td> <td colspan="4">TH-D75A: 346 g (12.20 oz)/ TH-D75E: 344 g (12.13 oz) (w/ Antenna, Belt Clip)</td> </tr> <tr> <td>with KBP-9</td> <td colspan="4">TH-D75A: 391 g (12.79 oz)/ TH-D75E: 389 g (13.72 oz) (w/ Antenna, Belt Clip, AAx6 Battery)</td> </tr> </table>	Body only	TH-D75A: 204 g (7.20 oz)/ TH-D75E: 203 g (7.16 oz)				with KNB-75LA	TH-D75A: 346 g (12.20 oz)/ TH-D75E: 344 g (12.13 oz) (w/ Antenna, Belt Clip)				with KBP-9	TH-D75A: 391 g (12.79 oz)/ TH-D75E: 389 g (13.72 oz) (w/ Antenna, Belt Clip, AAx6 Battery)																												
Body only	TH-D75A: 204 g (7.20 oz)/ TH-D75E: 203 g (7.16 oz)																																								
with KNB-75LA	TH-D75A: 346 g (12.20 oz)/ TH-D75E: 344 g (12.13 oz) (w/ Antenna, Belt Clip)																																								
with KBP-9	TH-D75A: 391 g (12.79 oz)/ TH-D75E: 389 g (13.72 oz) (w/ Antenna, Belt Clip, AAx6 Battery)																																								

TRANSMITTER													
RF Power Output	<table border="0"> <tr> <td>EXT.PS 13.8 V / Battery:7.4 V</td> <td></td> <td></td> <td></td> </tr> <tr> <td>H</td> <td>M</td> <td>L</td> <td>EL</td> </tr> <tr> <td>5 W</td> <td>2 W</td> <td>0.5 W</td> <td>0.05 W</td> </tr> </table>	EXT.PS 13.8 V / Battery:7.4 V				H	M	L	EL	5 W	2 W	0.5 W	0.05 W
EXT.PS 13.8 V / Battery:7.4 V													
H	M	L	EL										
5 W	2 W	0.5 W	0.05 W										
Modulation	<table border="0"> <tr> <td>FM</td> <td>Reactance Modulation</td> </tr> <tr> <td>DV</td> <td>GMSK Reactance Modulation</td> </tr> </table>	FM	Reactance Modulation	DV	GMSK Reactance Modulation								
FM	Reactance Modulation												
DV	GMSK Reactance Modulation												
Modulation Deviation	<table border="0"> <tr> <td>FM</td> <td>±5.0kHz</td> </tr> <tr> <td>NFM</td> <td>±2.5kHz</td> </tr> </table>	FM	±5.0kHz	NFM	±2.5kHz								
FM	±5.0kHz												
NFM	±2.5kHz												
Spurious Emissions	<table border="0"> <tr> <td>HI / MID</td> <td>-60 dBc or less</td> </tr> <tr> <td>L</td> <td>-50 dBc or less</td> </tr> <tr> <td>EL</td> <td>-40 dBc or less</td> </tr> </table>	HI / MID	-60 dBc or less	L	-50 dBc or less	EL	-40 dBc or less						
HI / MID	-60 dBc or less												
L	-50 dBc or less												
EL	-40 dBc or less												
Microphone Impedance	2 kΩ												

TH-D75A/ TH-D75E SPECIFICATIONS

Bluetooth	
Version, Class	Version 3.0, Class 2
Output Power	-6 < P _{av} < 4 dBm
Modulation Characteristics	140 ≤ Δf _{1avg} ≤ 175 kHz
Initial Carrier Frequency	-75 ≤ f _o ≤ +75 kHz
Carrier Frequency Drift	±25 kHz (One Slot packet) ±40 kHz (Three Slot Packet) ±40 kHz (Five Slot Packet)

GPS	
TTF (Cold start)	Approx. 40 sec
TTF (Hot start)	Approx. 5 sec.
Horizontal Accuracy	10 m or less
Receive Sensitivity	Approx. -141 dBm (Acquisition)
T _a = 25°C, Open sky	

Note:

- ◆ Specifications are subject to change without notice, due to advancements in technology.

Concerning the received frequency display, an unmodulated signal may be received. This is according to the set intrinsic frequency form.

	<Band A>	<Band B>
V x U reception	(V _{RX} + 57.15 MHz) x n - (U _{RX} - 58.05 MHz) x m = ±57.15 MHz, ±58.05 MHz	
	Example) Band A: 146.000 MHz, Band B: 147.6625 MHz, Band B receives un modulated signal.	
U x V reception	(U _{RX} - 57.15 MHz) x n - (V _{RX} + 58.05 MHz) x m = ±57.15 MHz, ±58.05 MHz	
	Example) Band A: 440.000 MHz, Band B: 147.6625 MHz, Band A receives un modulated signal.	
U x U reception	(U _{RX} - 57.15 MHz) x n - (U _{RX} - 58.05 MHz) x m = ±57.15 MHz, ±58.05 MHz	
	Example) Band A: 431.84375 MHz, Band B: 440.000 MHz, Band B receives un modulated signal.	
V x 220M reception	(V _{RX} + 57.15 MHz) x n - (220M _{RX} + 58.05 MHz) x m = ±57.15 MHz, ±58.05 MHz	
	Example) Band A: 145.740 MHz, Band B: 223.500 MHz, Band B receives un modulated signal.	
220M x V reception	(220M _{RX} - 57.15 MHz) x n - (V _{RX} + 58.05 MHz) x m = ±57.15 MHz, ±58.05 MHz	
	Example) Band A: 223.500 MHz, Band B: 147.535 MHz, Band B receives un modulated signal.	
U x 220M reception	(U _{RX} + 57.15 MHz) x n - (220M _{RX} + 58.05 MHz) x m = ±57.15 MHz, ±58.05 MHz	
	Example) Band A: 439.780 MHz, Band B: 223.550 MHz, Band B receives un modulated signal.	

V_{RX}: VHF reception frequency, U_{RX}: UHF reception frequency, 220M_{RX}: 220 MHz band reception frequency
n and m are arbitrary integers.

- 19.2 MHz x n (n = mutiple)
- 55.95 MHz x n (n = mutiple)
- Around 11.0592 MHz x n (n = mutiple) reception
- 144.385 MHz
- 147.465 MHz
- Around 224.25 MHz reception
- 442.385 MHz

KENWOOD

© 2024 JVCKENWOOD Corporation