

KENWOOD

KVT-M707

7-Inch WIDE SCREEN MONITOR-RECEIVER

INSTALLATION MANUAL

AMPLI-TUNER-MONITEUR GRAND ECRAN 7 pouces

MANUEL D'INSTALLATION

7-Zoll BREITBILD MONITOR-RECEIVER

INSTALLATION-HANDBUCH

7 inch BREEDBEELDMONITOR-RECEIVER

INSTALLATIE HANDLEIDING

SINTOLETTORE-MONITOR A SCHERMO AMPIO 7 pollici

MANUALE DI INSTALLAZIONE

REPRODUCOR-MONITOR DE PANTALLA PANORÁMICA DE 7 pulgadas

MANUAL DE INSTALACION

RECEPTOR DE MONITOR DE ECRÃ LARGO de 7 polegadas

MANUAL DE INSTALAÇÃO

Kenwood Corporation

Accessories

①

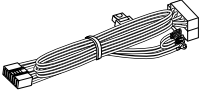

.....1

②

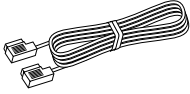

.....1

③

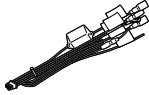

.....1

④



.....1

⑤

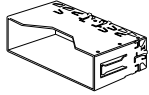

.....1

⑥

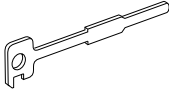

.....2

⑦



.....4

⑧



.....4

⑨



.....2

⑩

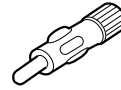

.....1

⑪

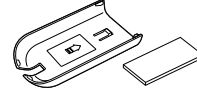

.....1

Installation Procedure

1. To prevent a short circuit, remove the key from the ignition and disconnect the ⊖ battery.
2. Make the proper input and output wire connections for each unit.
3. Connect the speaker wires of the wiring harness.
4. Connect the wiring harness wires in the following order: ground, battery, ignition.
5. Connect the wiring harness connector to the unit.
6. Install the unit in your car.
7. Reconnect the ⊖ battery.
8. Press the reset button.

▲WARNING

- If you connect the ignition wire (red) and the battery wire (yellow) to the car chassis (ground), you may cause a short circuit, that in turn may start a fire. Always connect those wires to the power source running through the fuse box.
- Do not cut out the fuse from the ignition wire (red) and the battery wire (yellow). The power supply must be connected to the wires via the fuse.

▲CAUTION

- If your car's ignition does not have an ACC position, connect the ignition wires to a power source that can be turned on and off with the ignition key. If you connect the ignition wire to a power source with a constant voltage supply, as with battery wires, the battery may die.
- If the console has a lid, make sure to install the unit so that the faceplate will not hit the lid when closing and opening.
- If the fuse blows, first make sure the wires aren't touching to cause a short circuit, then replace the old fuse with one with the same rating.
- Insulate unconnected wires with vinyl tape or other similar material. To prevent a short circuit, do not remove the caps on the ends of the unconnected wires or the terminals.
- Connect the speaker wires correctly to the terminals to which they correspond. The unit may be damaged or fail to work if you share the ⊖ wires or ground them to any metal part in the car.
- When only two speakers are being connected to the system, connect the connectors either to both the front output terminals or to both the rear output terminals (do not mix front and rear). For example, if you connect the ⊕ connector of the left speaker to a front output terminal, do not connect the ⊖ connector to a rear output terminal.
- After the unit is installed, check whether the brake lamps, blinkers, wipers, etc. on the car are working properly.
- Mount the unit so that the mounting angle is 30° or less.
- If the power is not turned ON (or it is ON, but will be OFF immediately), the speaker wire may have a short-circuit or touched the chassis of the vehicle and the protection function may have been activated. Therefore, the speaker wire should be checked.

Connection

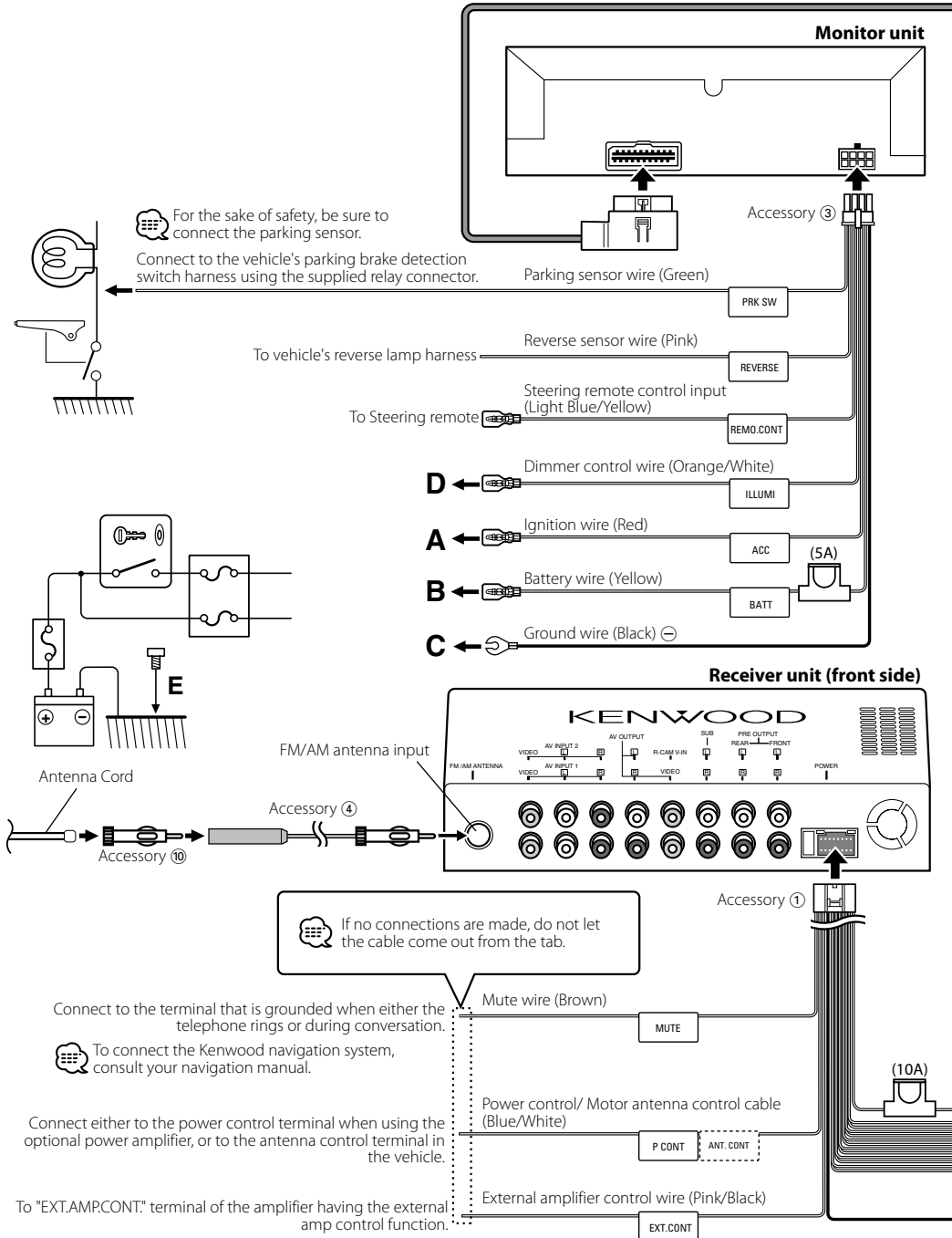

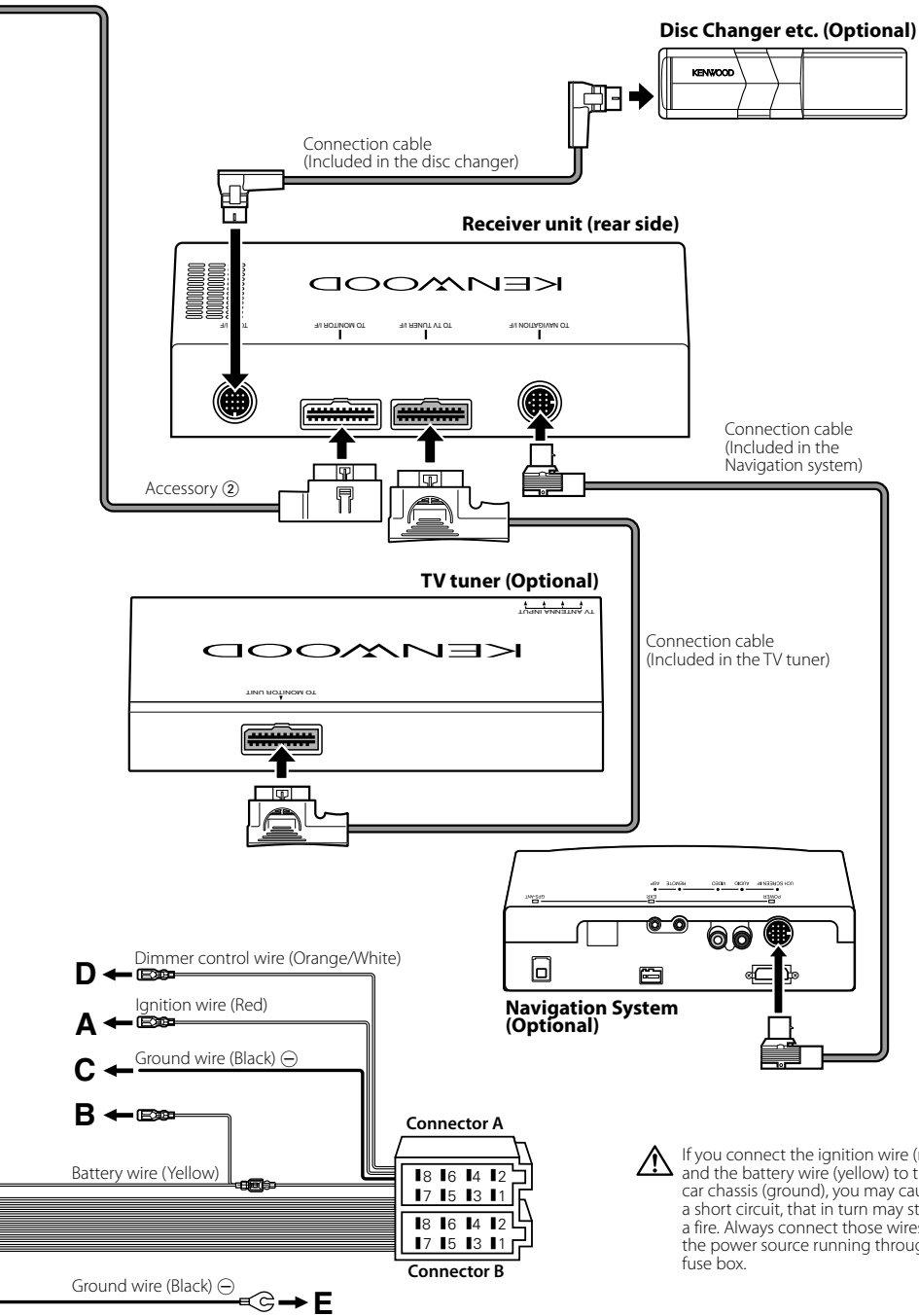

! If you connect the ignition wire (red) and the battery wire (yellow) to the car chassis (ground), you may cause a short circuit, that in turn may start a fire. Always connect those wires to the power source running through the fuse box.

Connecting the ISO Connector



The pin arrangement for the ISO connectors depends on the type of vehicle you drive. Make sure to make the proper connections to prevent damage to the unit.

The default connection for the wiring harness is described in [1] below. If the ISO connector pins are set as described in [2] or [3], make the connection as illustrated.

Please be sure to reconnect the cable as shown [2] below to install this unit to the Volkswagen vehicles etc.

- [1] (Default setting) The A-7 pin (red) of the vehicle's ISO connector is linked with the ignition, and the A-4 pin (yellow) is connected to the constant power supply.

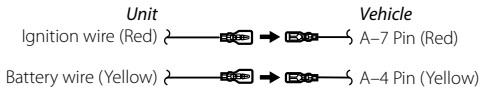

- [2] The A-7 pin (red) of the vehicle's ISO connector is connected to the constant power supply, and the A-4 pin (yellow) is linked to the ignition.

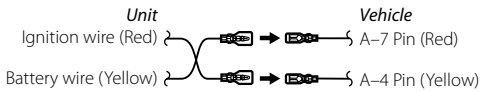

- [3] The A-4 pin (yellow) of the vehicle's ISO connector is not connected to anything, while the A-7 pin (red) is connected to the constant power supply (or both the A-7 (red) and A-4 (yellow) pins are connected to the constant power supply).

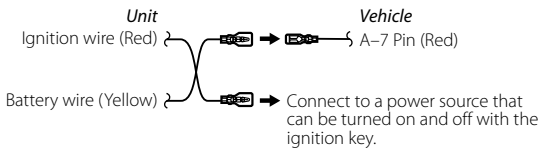

Connector Function Guide

Pin Numbers for ISO Connectors	Cable Colour	Functions
External Power Connector		
A-4	Yellow	Battery
A-5	Blue/White	Power Control
A-6	Orange/White	Dimmer
A-7	Red	Ignition (ACC)
A-8	Black	Earth (Ground) Connection
Speaker Connector		
B-1	Purple	Rear Right (+)
B-2	Purple/Black	Rear Right (-)
B-3	Gray	Front Right (+)
B-4	Gray/Black	Front Right (-)
B-5	White	Front Left (+)
B-6	White/Black	Front Left (-)
B-7	Green	Rear Left (+)
B-8	Green/Black	Rear Left (-)

Connection for AV Equipments

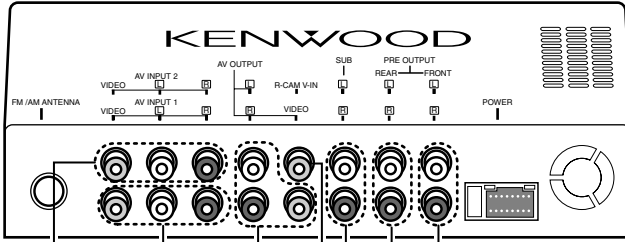

■ Front Preout

- Audio left output (White)
- Audio right output (Red)

■ Rear Preout

- Audio left output (White)
- Audio right output (Red)

■ Sub-woofer Preout

- Audio left output (White)
- Audio right output (Red)

■ Rear View Camera Input

- Visual input (Yellow)

■ Audio/Visual Output

- Visual output (Yellow)
- Audio left output (White)
- Audio right output (Red)

■ Audio/Visual input 1

- Visual input (Yellow)
- Audio left input (White)
- Audio right input (Red)

■ Audio/Visual input 2

- Visual input (Yellow)
- Audio left input (White)
- Audio right input (Red)

Installation for Monitor Unit

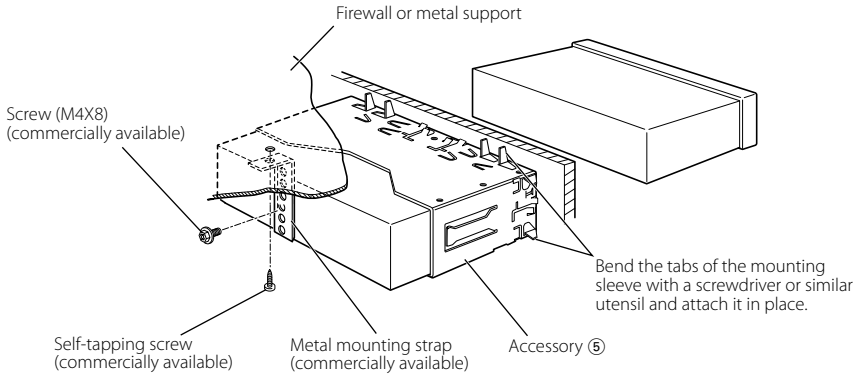

 Make sure that the unit is installed securely in place. If the unit is unstable, it may malfunction (eg, the sound may skip).

Installation for Receiver unit

1. Attach the installation brackets ⑨ to the sides of the hideaway unit using the sems bolts ⑦.

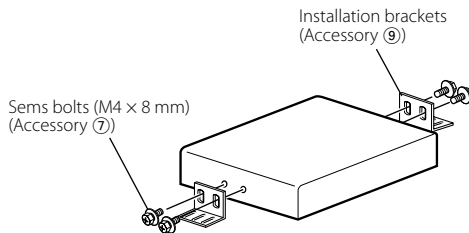

2. Use the tapping screw ⑧ to secure the hideaway unit to the audio board.

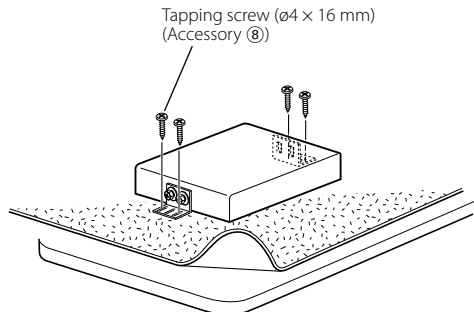

Removing Monitor Unit

■ Removing the Hard Rubber Frame (escutcheon)

1. Engage the catch pins on the removal tool (⑥) and remove the two locks on the lower level. Lower the frame and pull it forward as shown in the figure.

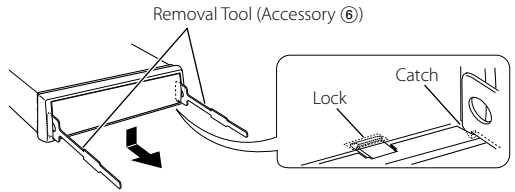

2. When the lower level is removed, remove the upper two locations.

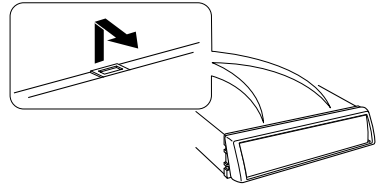

■ Removing the Unit

1. Remove the hard rubber frame by referring to the removal procedure in the section <Removing the Hard Rubber Frame>.
2. Remove the Hex-head screw with integral washer (M4 × 8) on the back panel.
3. Insert the two removal tools (⑥) deeply into the slots on each side, as shown.
4. Lower the removal tool toward the bottom, and pull out the unit halfway while pressing towards the inside.

 Be careful to avoid injury from the catch pins on the removal tool.

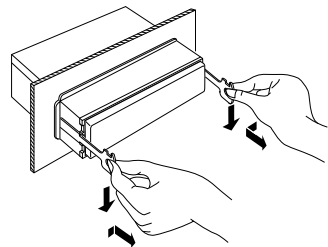
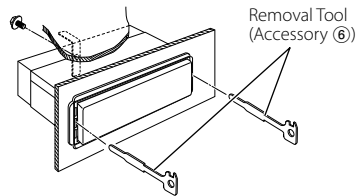

5. Pull the unit all the way out with your hands, being careful not to drop it.

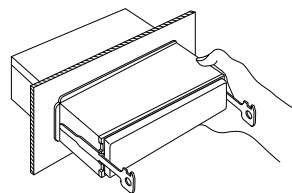

Installation of Remote control unit

■ Install the remote control unit holder (Accessory ⑪).

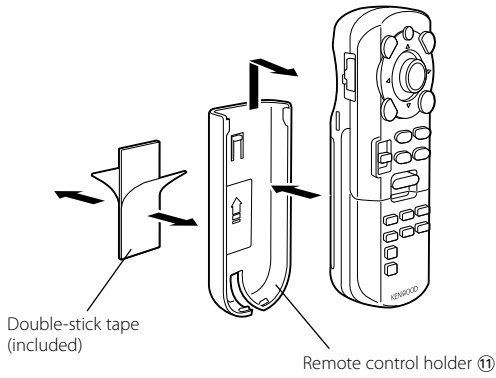

To prevent the Remote control unit from dropping down under your foot, install it using the Remote control unit holder. If the Remote control unit drops down under driving pedals, it will interfere with your driving and may result in a traffic accident.

